



Garden City Estate Guidelines

Revised Feb 2021



This page has been intentionally left blank

Cover image: Nearmap (Aerial photo taken April 2019).

Contents

Introduction

Purpose	4
Application	4
How to use the Guidelines	4

Guideline Basis

The significance of Garden City Estate	6
--	---

Guideline 1: Conservation

Roof guidelines	10
External walls and surfaces guidelines	10
Windows and doors guidelines	11
External decoration guidelines	12

Guideline 2: Alterations & Additions

Guidelines for single storey additions	14
Guidelines for two storey additions	15
Guidelines for alterations	16

Guideline 3: New Buildings

Guidelines	18
------------	----

Guideline 4: Car Parking

Guidelines	20
------------	----

Guideline 5: Fencing

Guidelines	23
------------	----

Guideline 6: Public Realm & Infrastructure

Guidelines	27
------------	----

Guideline 7: Subdivision

Guidelines	29
------------	----

Purpose

The Garden City Estate is a significant heritage place. It is essential that the City of Port Phillip and its residents maintain and enhance its unique character. It is also important that the needs of individual property owners are recognised. These guidelines are designed to strike a balance between these objectives. They describe the features that make the Garden City Estate significant and offer practical suggestions to help property owners maintain its significance, whilst allowing for renovations and development to occur.

The guidelines were initially prepared in 1997 and updated in 2010 and 2020. This version has been prepared to ensure alignment with updated heritage policy at Clause 15.03-1L of the Port Phillip Planning Scheme and the City of Port Phillip Heritage Design Guidelines (Background Document listed at clause 72.08 of the scheme).

Application

The guidelines apply to all land included in the Garden City Estate (also known as Bank House Estate). The area is bounded by the lane west of Graham Street, Williamstown Road, Howe Parade, Poolman Street and Walter Street at Port Melbourne (see Figure 1).

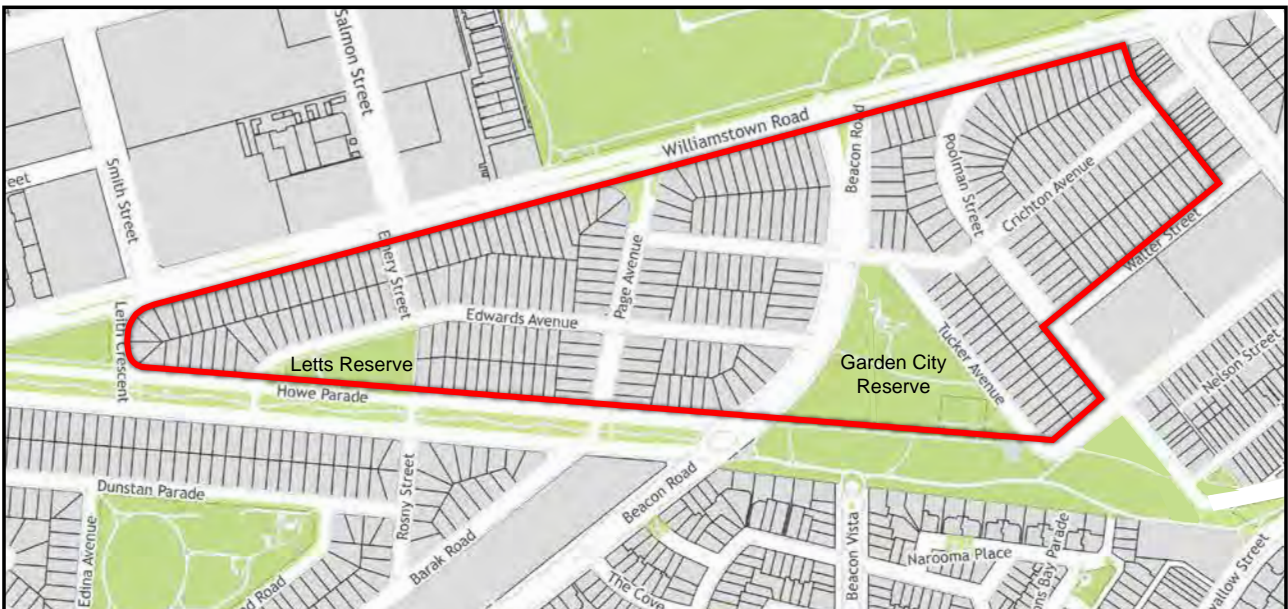

Figure 1. The Garden City Estate boundary shown in red

The area contains 322 dwellings, which were constructed for the State Savings Bank of Victoria between 1926 and 1948. The dwellings are built in pairs to six standard designs. The Garden City Estate also includes several recreational reserves.

How to use the Guidelines

The guidelines explain what Council will take into consideration when assessing a planning permit application for development or subdivision of land in accordance with Clause 43.01 Heritage Overlay of the Port Phillip Planning Scheme.

The guidelines should be considered in conjunction with State and local heritage policy at Clause 15.03 of the Port Phillip Planning Scheme, and the City of Port Phillip Heritage Design Guidelines.

In the event of any inconsistency between the guidelines and the City of Port Phillip Heritage Design Guidelines, these guidelines should be used for applications within the Garden City Estate.

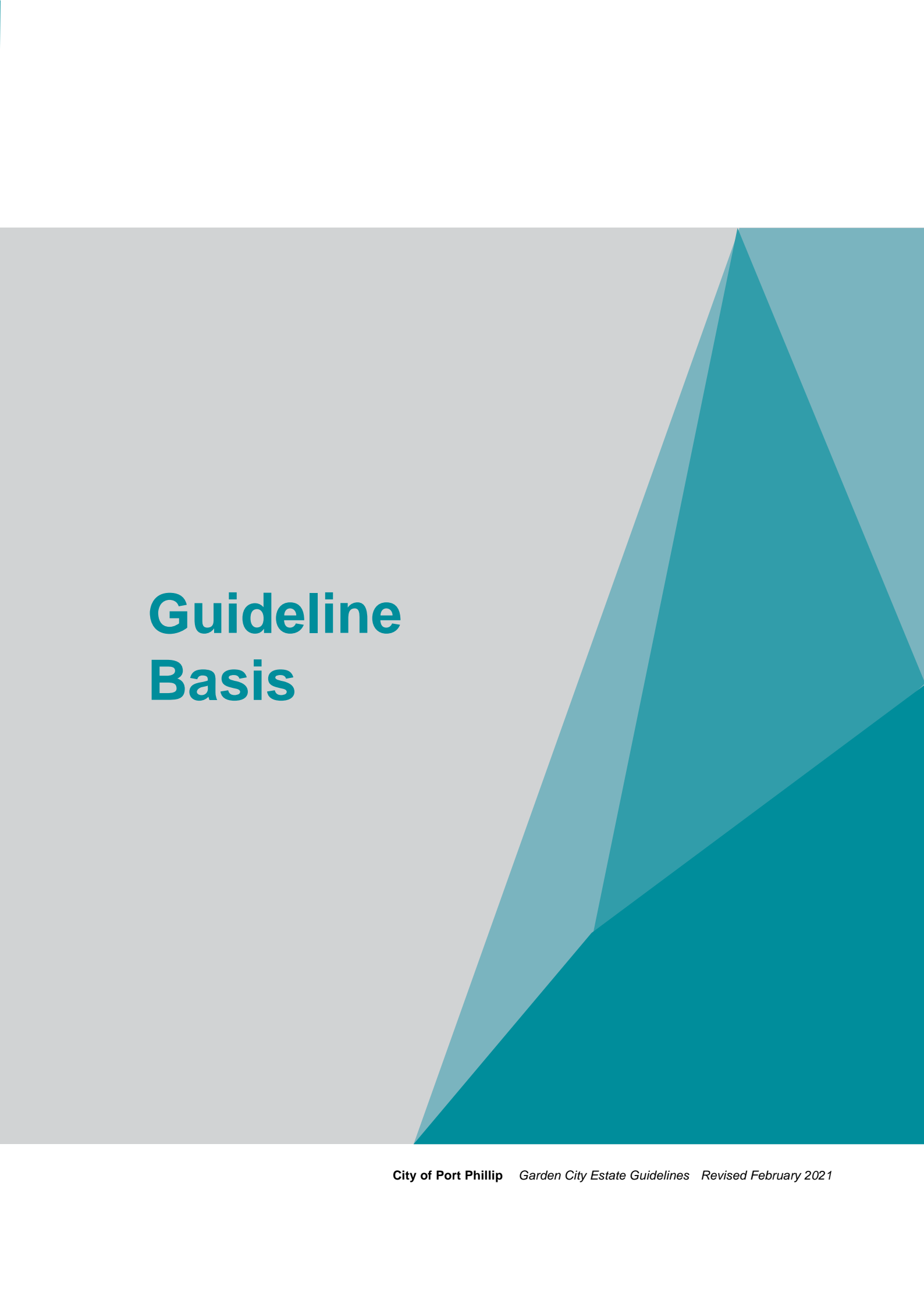

Guideline Basis

The significance of Garden City Estate

The Garden City Estate is of local heritage significance and is included within the heritage overlay of the Port Phillip Planning Scheme as part of HO2 The Garden City Housing Estates heritage precinct. The HO2 precinct comprises the three garden city estates, including Fishermans Bend Estate, the Garden City (Bank House) Estate and the Dunstan Estate.

The Garden City Estate was a unique experiment in mass housing, quite unlike anything else in Australia. Initiated by the State government through the State Savings Bank, it was Victoria's first attempt to provide low-cost housing on a single estate. Garden City Estate was influential on later State public housing policies as implemented through the Housing Commission of Victoria and the construction of many other public housing estates around the State.

The Garden City Estate was originally recognised as an area of special heritage significance in the Port Melbourne Conservation Study (1979) commissioned by the former Port Melbourne City Council and the Australian Heritage Commission. Garden City Estate was also classified by the National Trust of Australia (Victoria) in 1987. In 1995 Port Phillip City Council reaffirmed the significance of the Estate through the Port Melbourne Conservation Study Review (1995) and in 2000 recognised the estate as Significant on the Heritage Policy Map within the Port Phillip Planning Scheme.

Both the conservation study review and the National Trust classification report conclude that Garden City Estate is an area of State (and probably national) significance due to its:

- Contribution to the development of public housing policies and practices in Australia;
- Integrity and uniqueness as a residential environment;
- Relationship to the Garden City movement in Britain;
- Experimental building technology, residential planning and streetscape design.

Garden City Estate owes its special character to the unusual combination of social, administrative, planning and architectural factors that influenced its development over more than two decades. The consistent application of a single development philosophy over such a long period is unusual in itself. The layout of the sites and the design and orientation of the dwellings express the vision policy-makers had of working-class housing during the inter-war years. They also tell us much about the tastes and lifestyles of the time.

Standard house designs

The estate was designed according to the Garden City town planning philosophy popular in England earlier this century. The housing style within the estate and the general layout of the estate were extremely innovative for their time and were very different from the typical housing developments of the 1920s and 1930s. Figure 2 below provides a pictorial description of the six standard housing designs found within Garden City.



Type 1 Standard housing design



Type 2 Standard housing design



Type 3 Standard housing design



Type 4 Standard housing design



Type 5 Standard housing design

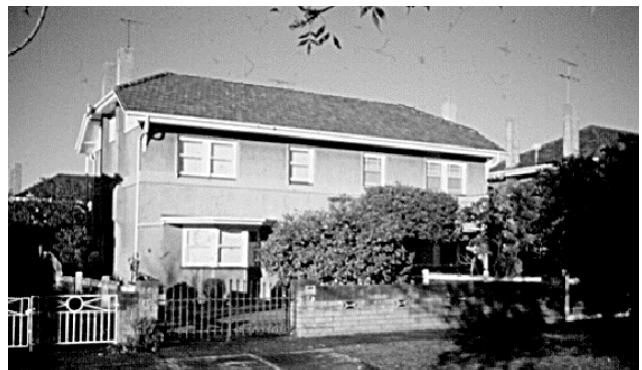

Type 6 Standard housing design

Figure 2. The six standard house designs

Important features

The most important feature of Garden City (Bank House Estate) is the uniform character of the streetscape.

In Garden City, the main streetscape elements are the dwellings, which are all two storey, attached houses on sites with a similar front and side setback. The consistent and prominent use of features like unglazed terracotta roof tiles, stucco walls (both rough-cast and smooth), woven wire fences and multi-paned windows contribute to the area's distinctive streetscape character.

The use of concrete for paving roads, footpaths and garden paths is another unifying aspect of the streetscape, as is the regular planting of only a few selected species of vegetation.

Most residential areas combine many different (and sometimes incompatible) approaches to design. In the case of Garden City, faithful adherence to a single design theme has produced an unusually harmonious and integrated urban environment – this is the key to the area's architectural and aesthetic significance. Figure 3 shows the important key features of the Garden City streetscape.

- ① Houses as semi-detached pairs with clear separation
- ② Consistent window, eave and porch details
- ③ Consistent stucco finishes
- ④ Wide eaves
- ⑤ Hipped, tiled roofs with chimneys
- ⑥ Regular tree planting at property boundaries
- ⑦ Grass nature strips
- ⑧ Concrete roads, kerbs, channels and crossovers
- ⑨ Transparent fences and gates

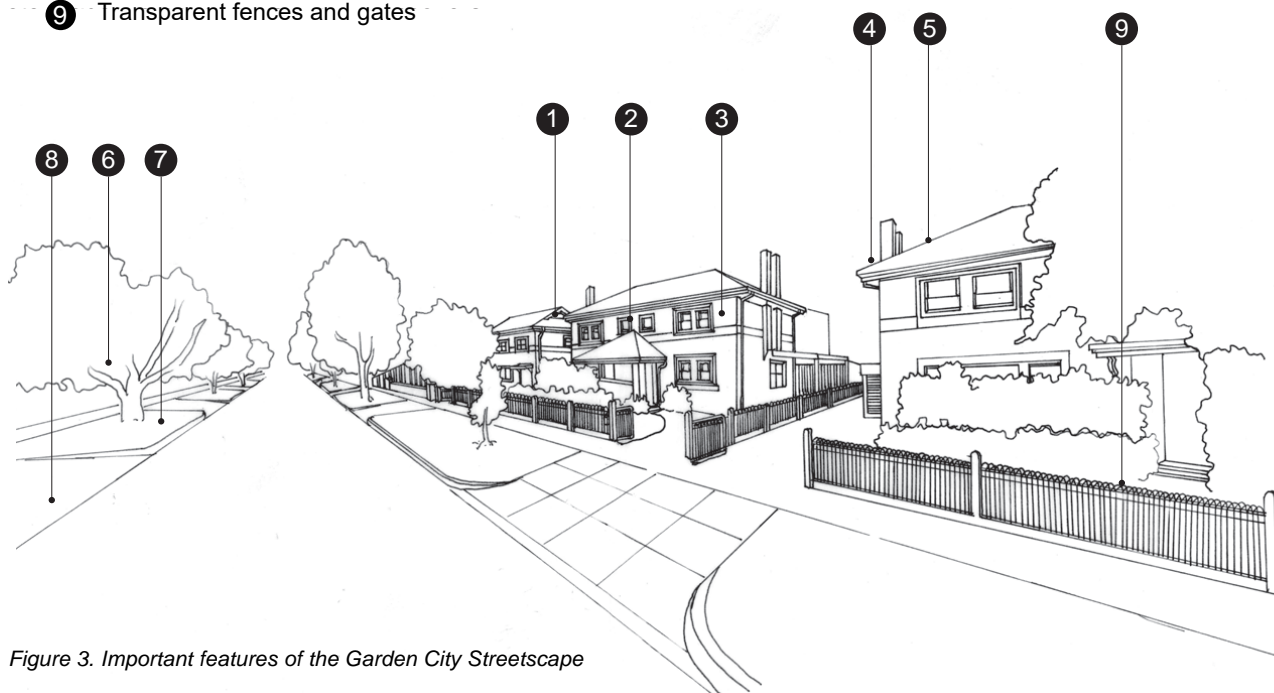
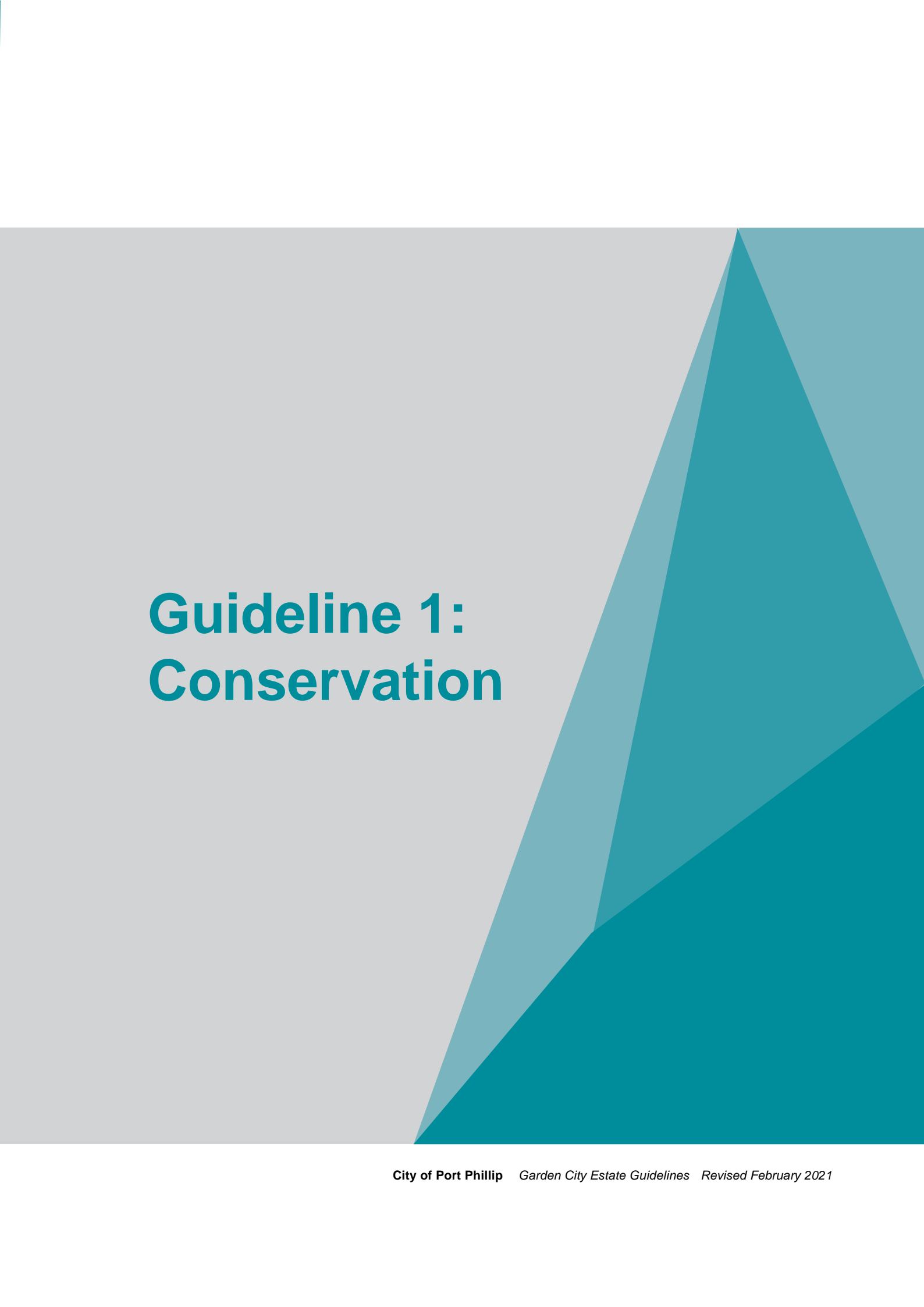

Figure 3. Important features of the Garden City Streetscape

The background features a light grey gradient on the left side, transitioning into a large, abstract teal shape on the right. This teal shape is composed of several overlapping triangles and polygons, creating a dynamic, geometric composition. The teal color is a rich, medium-dark shade.

Guideline 1: Conservation

Roof guidelines

The original roof form and materials should be retained and, if necessary, restored all the way along the front and side of the house.

Chimneys

- Original chimneys should be retained.

Downpipes

- Downpipes at the front of the house should be kept or returned to their original location where practical.
- Consideration will be given to removal or concealment of downpipes.

External walls and surfaces guidelines

- External walls which are visible from the street should be kept in their original form, with the original materials and finishes.
- Rendered surfaces should be restored by cleaning with an appropriate solution or by applying a cement-and-sand wash of the same colour and texture. The work should be undertaken by a qualified tradesperson.
- Repairs to rendered surfaces should match the colour, texture and composition of the original render.
- Rendered surfaces which have not been painted can be left unpainted or painted in colour matching the original render or cement.
- Rendered surface which have been painted should be restored where possible. Paint should be removed by an approved method (not sandblasting) and
- the surface should be treated with a cement-and-sand wash in the original colour (at least three different render colours were used on the estate).

Windows and doors guidelines

- Original windows and doors should be retained. If replacement is required, the new one should match the form and materials of the original.
- Double glazing of windows is permitted if it does not change the external appearance of the window.

Repairing cracked lintels

The lintels above many windows in Garden City are badly cracked. The cracking is usually caused by moisture seeping through the external skin of the building and corroding the steel reinforcing rods inside the lintel. It is worse on windows that face the weather (south and west). Windows on north and east facing walls and upper-storey windows protected by eaves are less likely to be affected.

- The best way to tackle severe cracking is to replace the lintel with a new one manufactured using dense concrete (at least 50Mpa). There should be at least 40mm of cover over the new lintel's steel reinforcing rods.
- Less seriously damaged lintels can be repaired using one of several patching systems. These involve removing the external concrete to expose the corroded reinforcing rods, treating the rods, concreting over them again, and restoring the external finish. This may seem like a cheaper option, but it is important to remember that patches typically last only about five years – replacing the lintel may be more economical in the long term.
- For more information about replacing lintels, it is recommended that you talk to a builder experienced in this field.

External decoration guidelines

- Window and door frames, fences, downpipes and gutters should be painted in the original colours, or a colour scheme typical of the area or the period. The original colours can usually be determined by scraping back to the wood one layer at a time. Figure 4 shows a range of possible colour schemes, although other schemes will be considered.
- Neighbours are encouraged to agree on one colour scheme for both houses in each pair.
- If the original natural stucco walls are already painted, either remove paint and apply cement wash, or repaint in Natural Grey.

- ① Gutter
- ② Fascia and scotia
- ③ Under eaves
- ④ Frame boxing
- ⑤ Sash
- ⑥ Sill
- ⑦ Bracket
- ⑧ Frame
- ⑨ Under canopy
- ⑩ Door and frame
- ⑪ Fence
- ⑫ Natural stucco walls (unpainted)

- a Dark trim**
 - Mid brunswick green
 - Leaf brown
 - Deep brunswick green
 - Deep indian red

- b Mid- range colour**
 - Biscuit
 - Deep buff

- c Light trim**
 - Off white
 - Cream
 - Manila

- d Natural grey**
 - Natural grey
 - Warm grey pale stone
 - Mid to light ochre

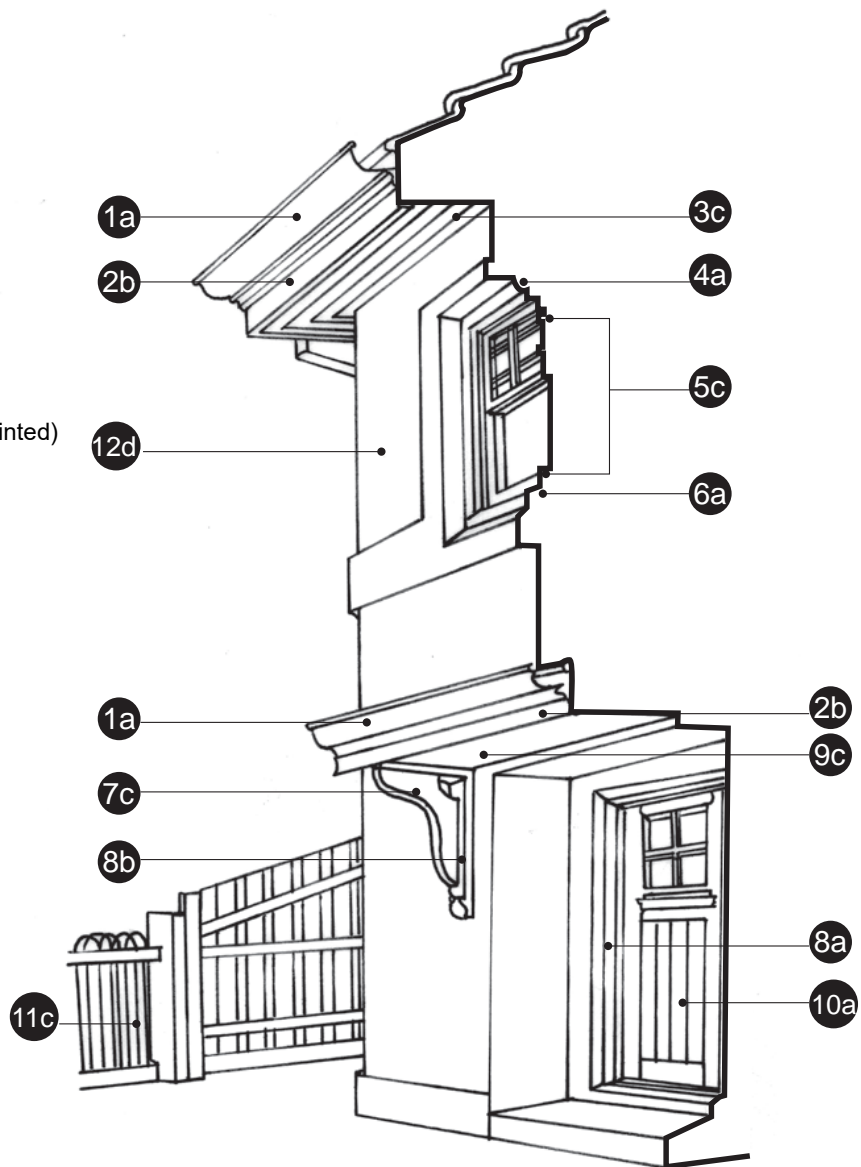



Figure 4. Facade articulations

A large teal geometric graphic on the right side of the page, consisting of several overlapping triangles and polygons in various shades of teal, creating a modern, abstract design.

Guideline 2: Alterations & Additions

Guidelines for single storey additions

Single storey additions are permitted at the rear of the house.

Single-storey additions (refer to Figures 5 and 6) may be permitted at the side of the house if:

- They respect and complement the house's original form, materials and character;
- They are more than 600mm setback from the front of the house, or more if there are original windows in the side wall;
- The extended boundary wall is rendered consistent with the finish of the original house on corner sites.

Single storey additions will generally not be permitted in other areas.

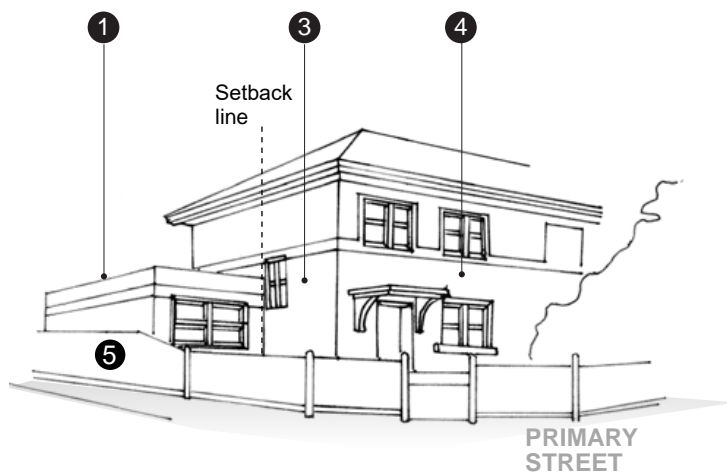

Figure 5. Single storey side addition in flat roof

- 1 Example consistent with original houses's material and details
- 2 Example matching house's hipped roof form
- 3 Setback from front of house
- 4 Front of house is the main wall and not any projecting bay or porch
- 5 Boundary wall of a corner block is rendered consistent with the finish of the original house

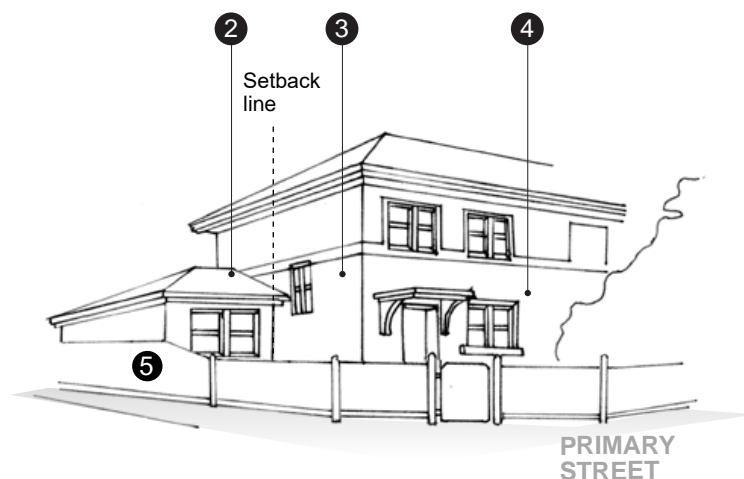

Figure 6. Single storey side addition in hipped roof

Guidelines for two storey additions

Two-storey additions are permitted at the back of the house if:

- The roof of the addition is no higher than the roof of the original dwelling;
- The walls of the addition are no higher than the walls of the original dwelling;
- The addition respects and complements the house's original form, materials and character (with a cement render or similar textured finish, and a flat or pitched roof with terracotta tiles); and

Two-storey additions will generally not be permitted in other areas, including the front of the house and the side of the house.



- ❶ Two-storey extensions are not allowed at the side of the house. Carports and garages should be set back no less than 600mm from front front house
- ❷ Keep two-storey extensions out of sight behind existing houses

Figure 7. Two storey additions to a building in Garden City.

Guidelines for alterations

Windows and doors

- New or enlarged window and door openings will not be permitted at the front of the house.
- Double glazing of windows is encouraged.
- Double glazing of windows is permitted if it does not change the external appearance of the window
- Refer to *Guideline 1 Conservation* for painting windows and doors.

Air conditioners

- Building services such as air conditioners should not be visible from the street.

Porches and entries

- Porches and entries may be enclosed with transparent screens that are at least 75 percent transparent or with plain glazing with the minimum of framing and glazing bars.
- New porches should not be located at the front of a house, or where it is visible from the street.

Blinds and awnings

- Sunblinds and awnings (temporary and permanent) should complement the character of the house.

Shutters

- Security screens may be installed, if they are
 - At the back of the house
 - At the side of the house and are more than halfway back from the front of the house
 - Inside the windows at the front of the house
- External screens and timber shutters over front windows are discouraged.

The background features a large, abstract geometric composition. On the right side, there are several overlapping triangles in various shades of teal and blue, pointing towards the top right. The left side of the page is a solid light grey. The text is positioned on the grey area, to the left of the teal shapes.

Guideline 3: New Buildings

Guidelines

- Multi-unit development (more than one residential dwelling per lot) will not be permitted as this is contrary to the significance of the estate.
- Single-storey granny flats located at the rear of the property may be permitted.
- Any proposed granny flat must be sympathetic and consistent with these guidelines.

The background features a large, abstract geometric design. On the right side, there is a large teal triangle pointing upwards, which overlaps with a lighter teal triangle. The left side of the page is a solid light grey color.

Guideline 4: Car Parking

Guidelines

- New garages and carports should be built at the side of the house and set back not less than 600mm from the front of the house, or more if there are original windows in the side wall.
- Garages should have cement render or similar textured finish walls, and a flat or hipped roof with terracotta tiles.
- Carports should be freestanding with a flat roof as shown in Figure 8. The space in front of a dwelling should be retained as lawn or garden and not used as a space to park vehicles.
- New garages and carports should be positioned to retain the original staggered line of houses along the street. (Refer to Figure 9)

- ① Gutter
- ② Scotia moulding
- ③ Timber fascia
- ④ Timber horizontal beam
- ⑤ Tray deck roofing
- a Nominal 2.55 meters
- b Nominal 2.865 meters and to align with porch height of house
- c Square timber posts or circular metal columns 250mm diameter
- d Maximum dimension 2.5 meters

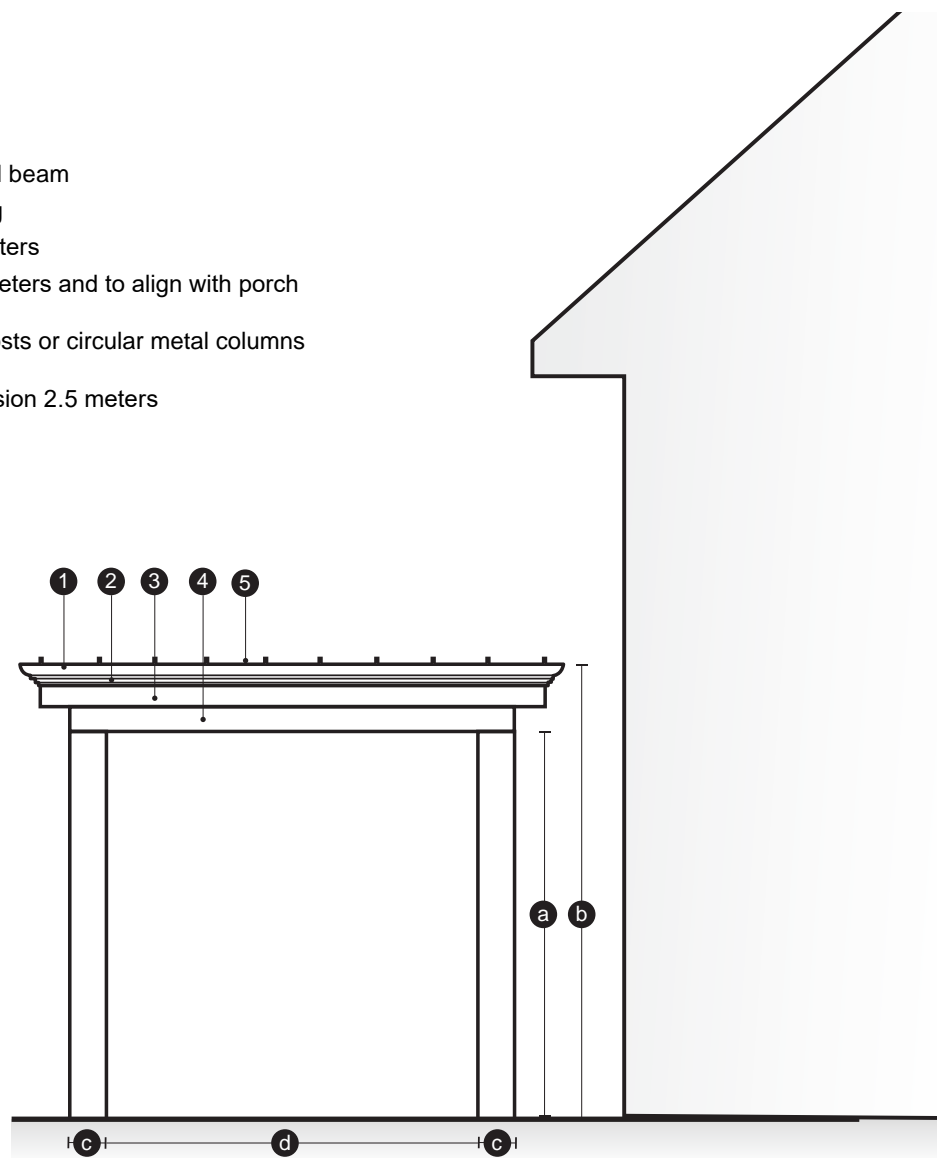

Figure 8. Acceptable garage and carport types - Carport with flat roof

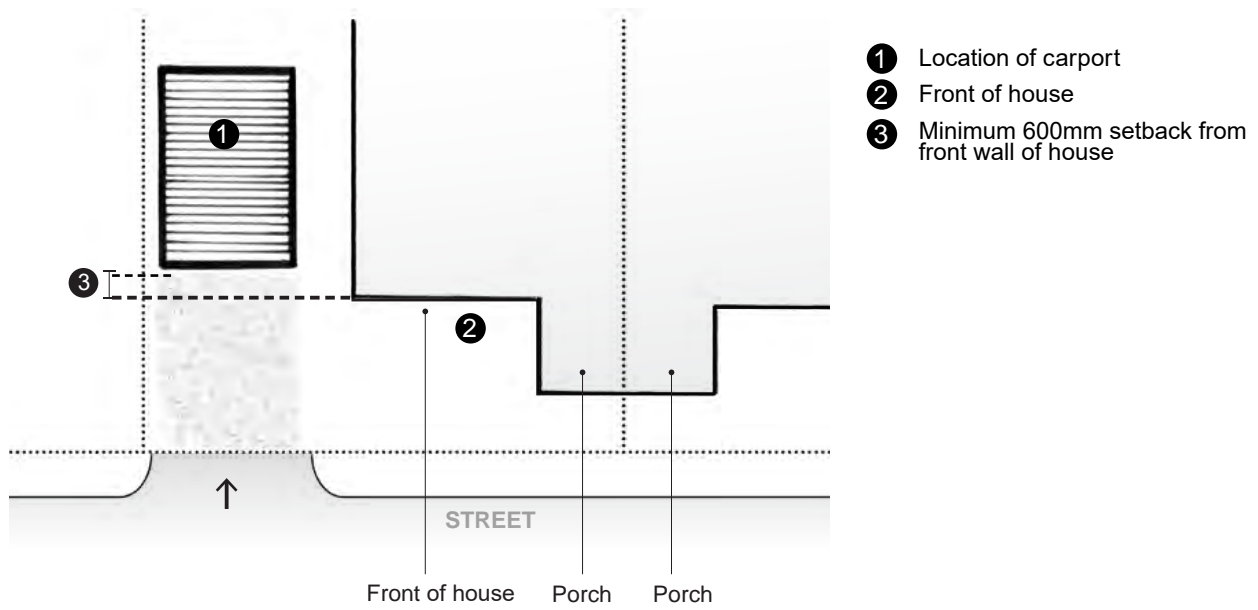

Figure 9. Acceptable garage and carport types - Site Plan

The background features a large, abstract geometric composition. On the right side, there are several overlapping triangles in various shades of teal and blue, pointing towards the top right. The left side of the page is a solid, light grey color. The text 'Guideline 5: Fencing' is positioned on the left, overlapping the grey area.

Guideline 5: Fencing

Guidelines

Front fences and side fences from the front boundary to front of the house (see Figure 10) should be:

- Woven wire as shown in Figure 11 or timber picket as shown in Figure 12.
- No more than 1 meter high if woven wire, and 900mm if timber picket.
- Minimum 75% transparent with exception of picket fences.

As shown in Figure 13, back fences and side fences from the front of the house to the back boundary should be

- No more than 2 metres high.
- Made from timber palings or other suitable materials as agreed between the neighbours.

Residents seeking more visual privacy are encouraged to use a combination of acceptable fencing and screen plantings such as hedges or bushes.

Refer to Guideline 9 for painting fences.

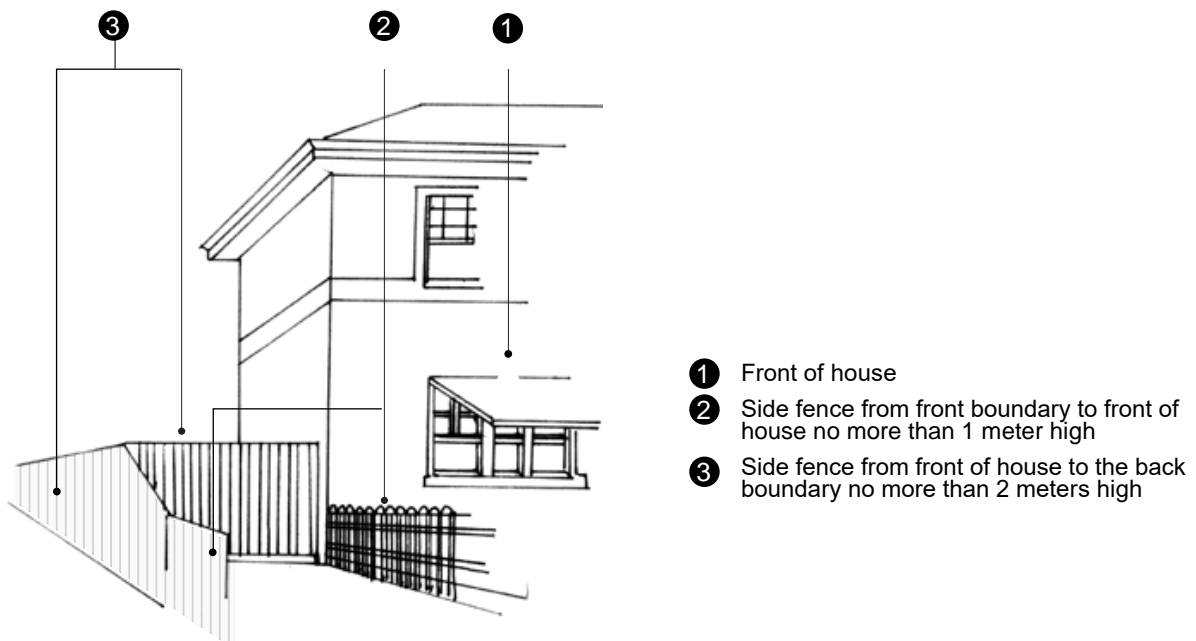
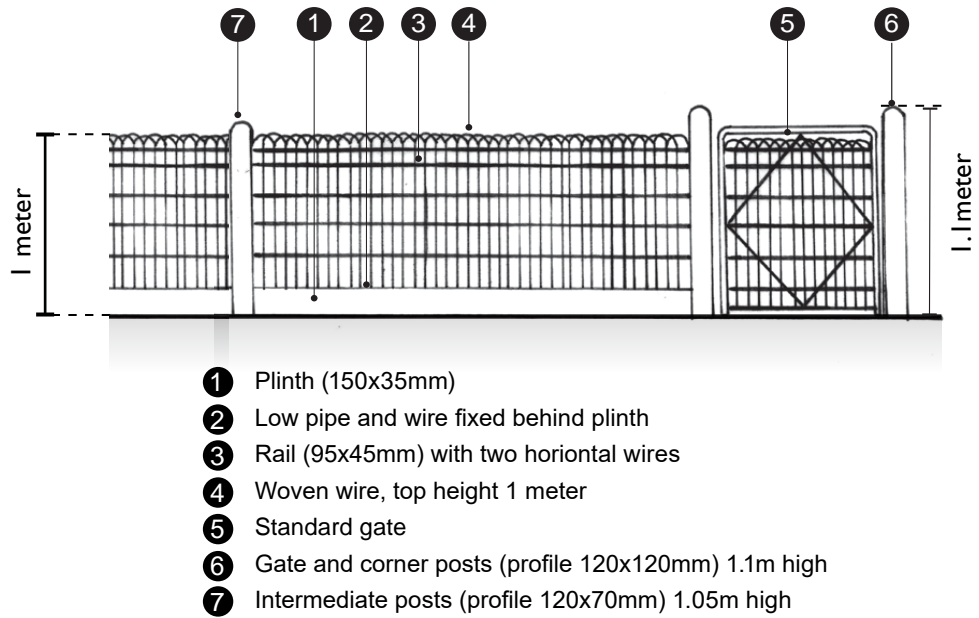
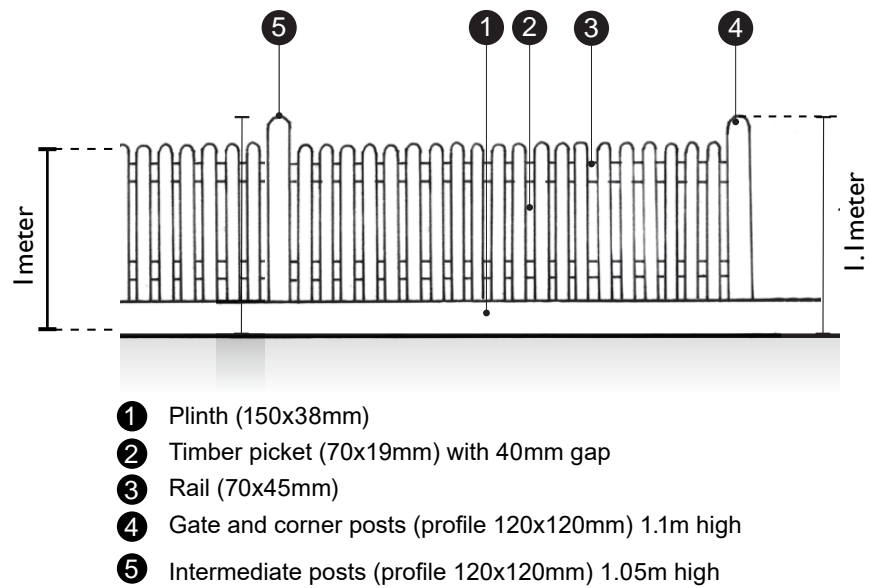

Figure 10. Front and side fence



- ① Plinth (150x35mm)
- ② Low pipe and wire fixed behind plinth
- ③ Rail (95x45mm) with two horizontal wires
- ④ Woven wire, top height 1 meter
- ⑤ Standard gate
- ⑥ Gate and corner posts (profile 120x120mm) 1.1m high
- ⑦ Intermediate posts (profile 120x70mm) 1.05m high

Figure 11: Woven wire fence



- ① Plinth (150x38mm)
- ② Timber picket (70x19mm) with 40mm gap
- ③ Rail (70x45mm)
- ④ Gate and corner posts (profile 120x120mm) 1.1m high
- ⑤ Intermediate posts (profile 120x120mm) 1.05m high

Figure 12: Picket timber fence

Fencing

- ① Gate post 950mm
- ② End post 1.35 m
- ③ Top of the fence 1.95 m
- ④ Optional splay

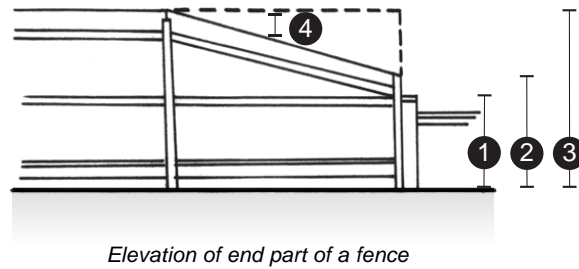

- ① Plinth (150 x 25mm)
- ② Straight
- ③ Alternative tops
- ④ Castellated
- ⑤ Sawn Palings
- ⑥ Posts (125 x 75mm)
- ⑦ HW rails (100 x 50mm)
- ⑧ Bottom rail 320mm
- ⑨ Middle rail 1.04m
- ⑩ Top rail 1.75m
- ⑪ Top of the fence 1.95m
- ⑫ Post spacing (2.4 - 2.7m)

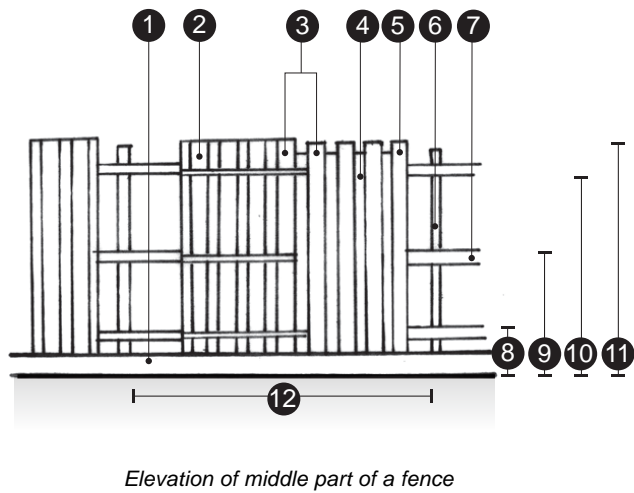

- ① Sawn Palings
- ② HW rails (100 x 50mm)
- ③ Posts (125 x 75mm)
- ④ Plinth (150 x 25mm)

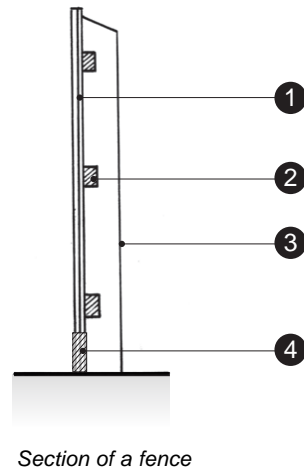
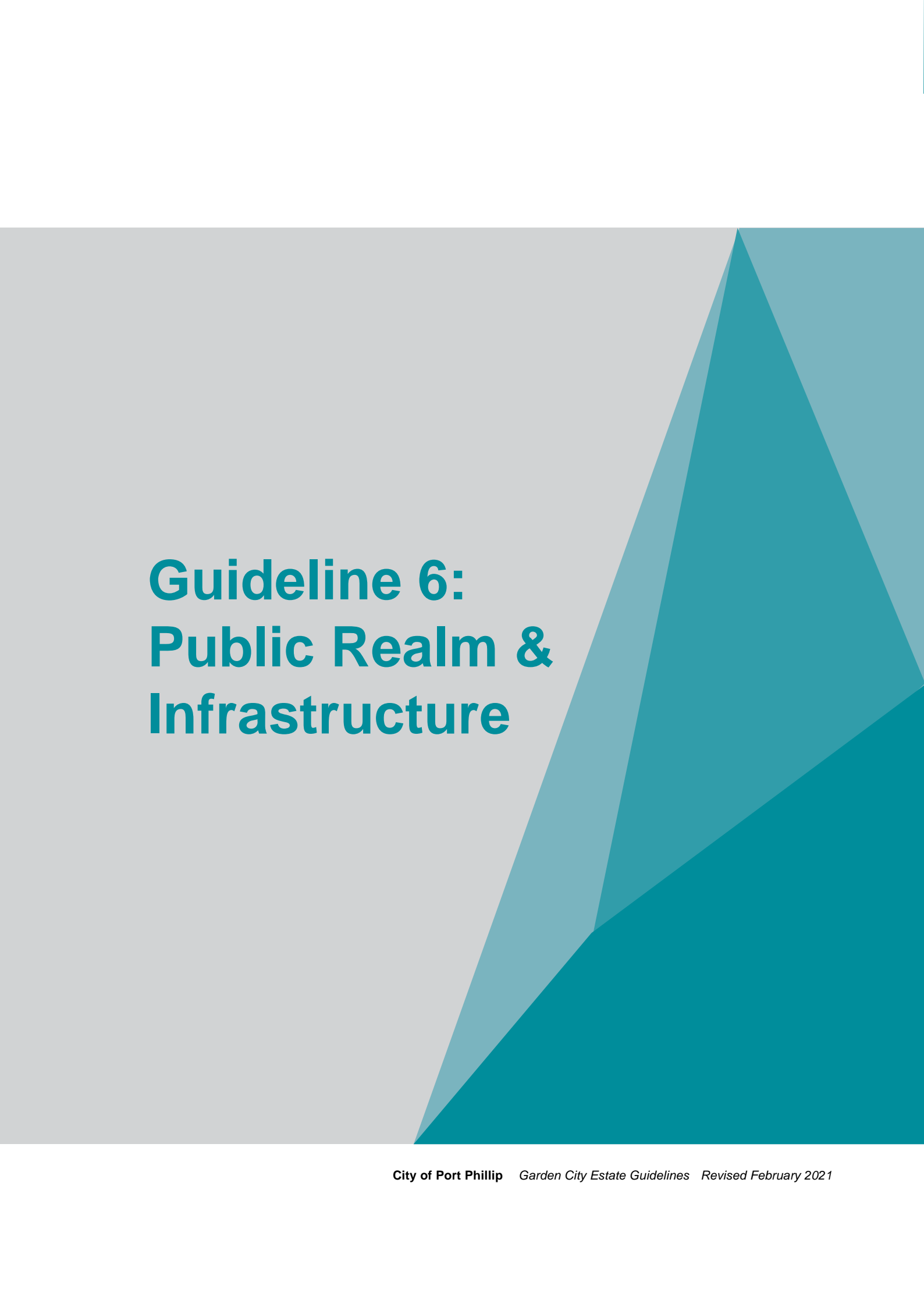

Figure 13: Side and rear fence

The background features a large, abstract geometric composition. On the right side, there are several overlapping triangles in various shades of teal and blue, pointing towards the top right. The left side of the page is a solid, light grey color. The text is positioned on the left side, overlapping the grey area.

Guideline 6: Public Realm & Infrastructure

These guidelines apply to all works within the public realm in Garden City including:

- Roads and road surfaces;
- Kerbs and channels, footpaths and crossovers;
- Nature strips and parks.

Guidelines

- Works within the public realm should be designed to be consistent with the form and materials of the original works and kept within the original design and street layout, but to modern-day standards;
- Any new works which are not part of the original design (such as kerb extensions) should be consistent with the form and materials of comparable existing works within the estate;
- Speed humps should be constructed from asphalt;
- Roundabouts should not alter any original kerb lines;
- The original uniformity of street trees should be retained.



Guideline 7: Subdivision

Guidelines

- Subdivision of original lots is discouraged.