

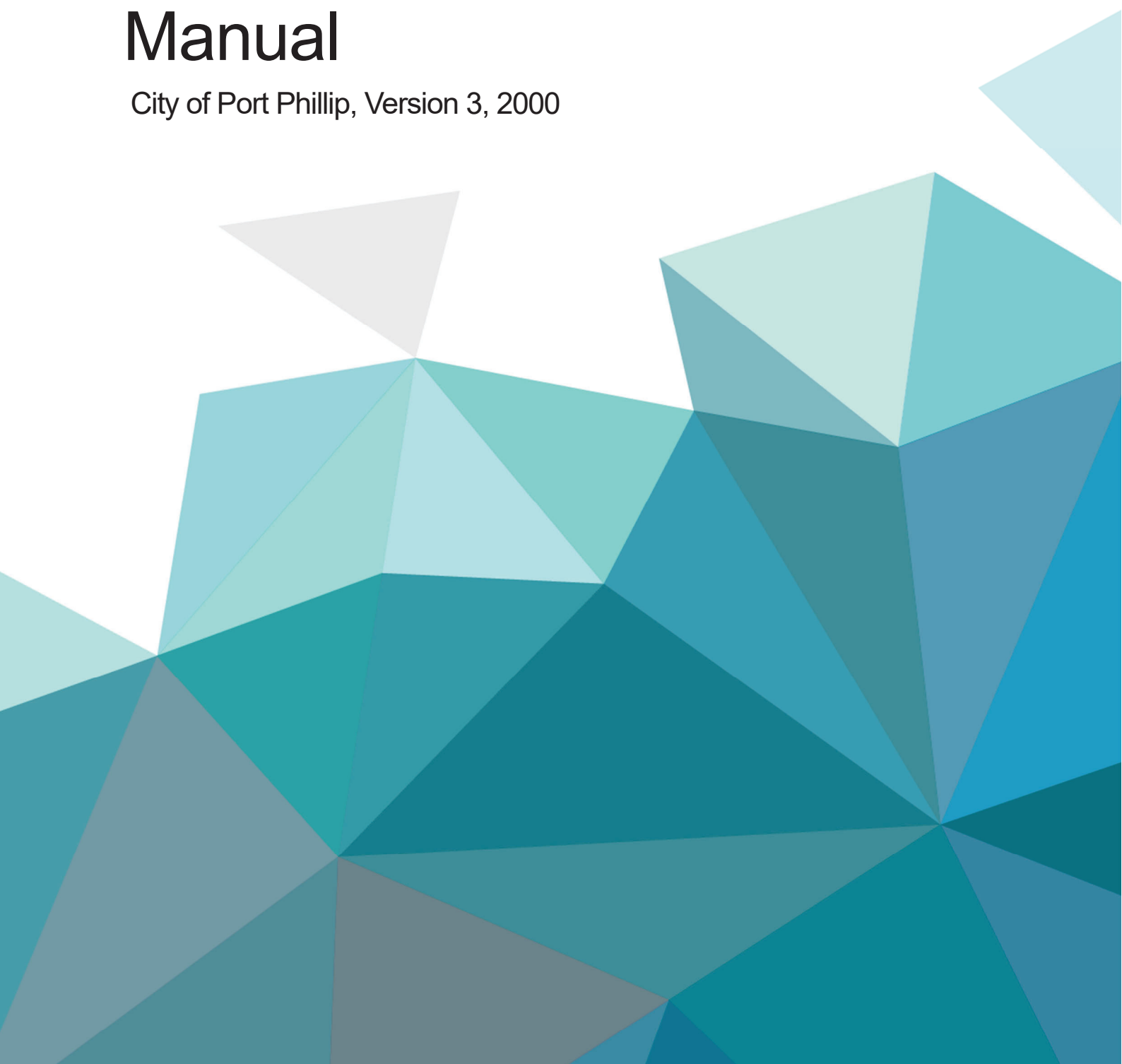

Port Phillip Design Manual

City of Port Phillip, Version 3, 2000



The Port Phillip Design Manual, Version 3, 2000 was included as a Reference Document in the Port Phillip Planning Scheme as a part of Amendment C5 (Neighbourhood Amendment).

In 2007 the Dunstan Estate Guidelines were adopted and included into this Design Manual.

In 2010 the Garden City Estate & Fishermans Bend Guidelines were reviewed, updated and adopted.

The Port Phillip Design Manual remains as a Reference Document to the Port Phillip Planning Scheme.

PREAMBLE

CONTENTS

Chapter 1 - Conservation details for various
Architectural Eras in Port Phillip

Chapter 2 – Garden City Estate Guidelines

Chapter 3 – Guidelines for Garage and/or Carport
Structures

Chapter 4 – Neighbourhood Character Descriptions

Chapter 5 – Fishermans Bend Estate Guidelines

Chapter 6 – Dunstan Estate Guidelines

Chapter 7 – Carlisle Street Environs

Chapter 8 – Bay Street Environs

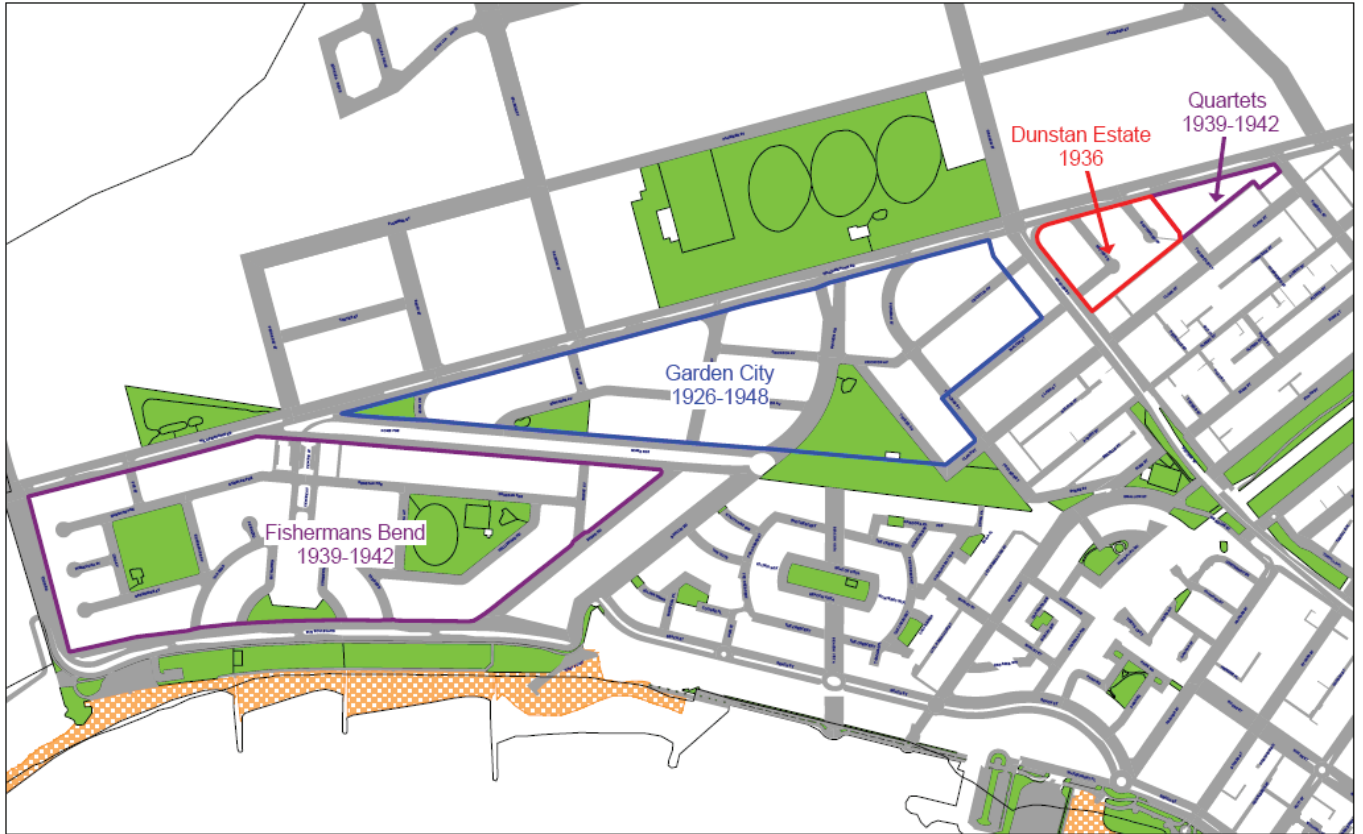

Map of the housing estates within the Garden City neighbourhood: Fishermans Bend (including the Quartets), Garden City & Dunstan Estate.

CONSERVATION details

The following guidelines summarise the main elements of a building in each of the architectural eras predominant in the City of Port Phillip.

The Glossary attached to these Guidelines provides an explanation of some of the specialist architectural terms used.

i) Early Victorian (1850s)

ITEM	DESCRIPTION
<i>Materials / Colours</i>	
Roof	Slate or unpainted corrugated iron with galvanised sheet metal cover flashings; possibly split shingles covered or replaced by corrugated iron later.
Walls	Lime washed, brick work (locally made bricks), with flush struck lime mortar joints, some natural finish cement rendered, often since painted; or timber weather boards (very occasionally shaped edges) with timber stops and corners. Bluestone footings. Bluestone.
Verandah Floor	Timber. Chequered slate and marble. Terra-cotta.
Colours	Walls: yellow cream, ochre wash, or natural brick, stone or cement render. Joinery and trim: semi gloss finish in cream, light stone, light brown, rich brown, Indian Red, olive and deep Brunswick Green (Prussian Blue or dark tints should be used only in restricted situations on large buildings), and limited use of graining to doors and windows.
Elements	
Roof Form	Hipped roof generally 20 to 30 degrees, pitch with some simple parapets.
Chimneys	Multiple or single and symmetrically placed.
Eaves	Small or no eaves hoverhang, occasionally with simple brackets or simple parapet.
Verandah	Skillion or hipped, convex/concave corrugated galvanised iron roof to verandah; generally to ground floor only, and not always included. Verandah roof form always separate from main roof; timber post generally.
Facade Form	Generally simple, quiet planar facade (with or without verandah).
Windows	Double hung sash windows with simple forms and arrangements; often multi-plane sashes.

Doors	Four panel bolection moulded doors
Gutters	Ogee or half-round profile with timber mould below.
Fence	Types of fences used include early timber picket, cast iron palisade, corrugated galvanised iron sheet (for side fence) and hooped metal overlapping palisade.
Other	Single or double storey. Double storey either with or without verandah or to ground floor only. Single storey either with or without verandah.

Ornamentation

Roof	Nil
Eaves	None or narrow sometimes with bracket and simple cornices.
Chimneys	Simple corbelled brick detail to brick chimneys. Cornices to rendered brick chimneys.
Parapets	Simple and rendered.
Verandahs	Timber posts, sometimes openwork in timber.
Window/door framing	Simple mouldings/architraves or rendered quoins on substantial houses.
Glazing	Toplights in front doors, multi-pane sashes and occasional use of French doors.

Proportions

Facade Composition	Rectangular box.
Facade Break Up	Divisions vertically with setbacks and fenestration. Division horizontally with eaves, string coursing and verandahs.
Openings	Vertical rectangles, generally symmetrically arranged.
Siting and Plan Form	Generally either built to street alignment or with minimal setbacks, generally quite uniform, villas in large grounds, terraces, semi-detached and detached examples. The plan generally consists of two front rooms with a central passage (double fronted width) or side passage (single fronted width) leading to two back rooms. The front rooms are roofed by a hipped roof and the back rooms are roofed by a skillion attachment or a hipped roof.

ii) Italianate (1850s to 1880s)

ITEM	DESCRIPTION
<i>Materials / Colours</i>	
Roof	"M" shaped hipped slate roof to generally detached villas. Corrugated iron to verandah. Gables used in various houses.
Walls	Rendered brick, sometimes on a bluestone plinth with mouldings and cast cement ornament.
Verandah Floor	Timber or tiles
Colours	Walls: Rendered walls generally unpainted. Framings: darker colours (including black). Sashes: lighter colours (including white). Window/door framing: graining or paint. Woodwork: brown, dark red, dark green.
Elements	
Roof Form	15 to 25 degrees pitch. Hipped, occasionally gabled.
Chimneys	Most commonly symmetrically placed, generally multiple.
Eaves	Narrow eaves with brackets and occasional use of wide eaves.
Verandah	Concave corrugated galvanised iron roof, cast iron or timber columns, often with return portion; verandah roof separate from main roof.
Facade Form	Multi-planar. Occasionally a square tower at the front of the roof and a projecting front room.
Windows	Double hung, sometimes with curved head. Complexity of types, heights and usage. Upper floors with some full length sashes, often to verandahs.
Doors	Four panel doors with sidelights and toplights.
Gutters	Ogee profile.
Fence	Fence types include cast iron palisade, timber picket and corrugated galvanised iron (for side fence).
Other	String coursing often continues over curved opening beads.

Ornamentation

Roof	Slate, corrugated galvanised iron, often with lead ridge capping.
Eaves	Mouldings and brackets.
Chimneys	Cornices, panels and mouldings.
Parapets	None or balustraded.
Verandahs	Timber bressumer or cast iron (more common) valances.
Window/door framing	Mouldings to head and surrounds, very occasionally with attached pilasters.
Glazing	Coloured and etched glass often used to sidelights.

Proportions

Facade Composition	<p>Rectangular. Classical, balanced, asymmetrical arrangement. Generally detached villas.</p> <p>Projecting section has square to vertical rectangles grouped horizontally. Facade divided horizontally by string courses, eaves, plinth and verandah form.</p>
Openings	Windows as vertical rectangles (some triple lights).
Siting and Plan Form	<p>Varying setbacks to street, generally detached.</p> <p>Plan form based on a front section containing four rooms with a central passage, with a valley/hip roof structure above. This era also generally included a projecting section of the front facade with an octagonal bay window element often included.</p>

iii) Mid-Late Victorian (1860s to 1880s)

ITEM	DESCRIPTION
<i>Materials / Colours</i>	
Roof	“M” shaped roof with patterned or plain slate (hip exposed or behind parapet); corrugated iron to verandah.
Walls	Face brick (Hawthorn brick, later red brick) with flush struck lime mortar joints or smooth rendered. Tuck pointing. Limited polychrome in 1880’s. Square edged timber weatherboards with timber stops to corners. The fronts of many weatherboard buildings used imitation ashlar boards. Bluestone fittings. Bluestone.
Verandah Floor	Timber. Terra-cotta tiles or encaustic tiles.
Colours	Walls: Sandstone, ochre, salmon pink, natural brick or cement render. Joinery: Gloss finish in cream, light stone, light brown, rich brown, Indian Red, and Brunswick Green. Window/door framing: Graining to doors and windows. Major doors generally dark colour, with lighter colour for panels.
Elements	
Roof Form	20 to 30 degrees pitch. “M” shaped, hipped.
Chimneys	Symmetrically placed, generally multiple.
Eaves	Tall parapets often to front facade. Narrow eaves.
Verandah	Concave or convex corrugated galvanised iron to roof. verandah roof separate from main roof, often with gabled porch roof built-in.
Facade Form	Quite flush, often with projecting masonry wing walls. Some arcading and projecting verandahs.
Windows	Double hung, sometimes with sidelights of varying vertical proportions.
Doors	Four panel, with basalt threshold (as for window sills).
Gutters	Ogee profile galvanised iron with timber mould below.
Fence	Fence types include cast iron palisade, timber picket and corrugated galvanised iron (for side fence) or hedges.
Other	Both single and double storey with verandahs/balconies to each level common.

Ornamentation

Roof	Cast iron cresting and finials sometimes used.
Eaves	Panelled entablature to eaves on front facade, particularly on later examples.
Chimneys	Corbelled brick detail to face brick chimneys and cement render cornices to face brick or rendered brick chimneys.
Parapets	Increasingly elaborate decoration, deep corncicing, decorative parapets with urns and pediments and rendered/timber brackets.
Verandahs	Cast iron columns, balustrading, friezes, brackets (1870s/80s); or timber verandah posts and frieze, often to weatherboard house.
Window/door framing	Wood graining popular, mostly to doors.
Glazing	Coloured and etched glass sometimes used to front door (1870's/80s).

Proportions

Facade Composition	Strong rectangles and verandah elements and a formal arrangement of elements.
Horizontal verandah lines, string coursing and parapet.	Columns divide facade into smaller horizontal and vertical rectangles.
Openings	Vertical rectangles, generally symmetrically arranged.
Siting and Plan Form	Generally setback from street alignment including terraces, semi-detached and detached examples. Plan form similar to Italianate. To increase the internal space and articulate the facade, gabled or hipped wings were sometimes added.

iv) Boom Style (1880s to early 1890s)

ITEM	DESCRIPTION
<i>Materials / Colours</i>	
Roof	Patterned or plain slate or corrugated galvanised iron either hipped, gabled or behind parapet; Corrugated iron concaves or bullnose roof to verandah.
Walls	Tuck pointed brickwork, elaborate render work, face brick work and polychromatic brickwork distinguished this style from earlier eras.
Verandah Floor	Terra-cotta tiles, encaustic tiles or, for more expensive houses, marble.
Colours	Walls: Stone, ochre, dark colours, natural brick or cement render. Joinery: Gloss finish in cream, light stone, light and middle browns, rich brown, Indian Red, various greens including Brunswick Green (Prussian Blue or dark tints used in restricted situations). Window/door framing: Graining to main door.
Elements	
Roof Form	Low pitched "M" shaped, hipped roof behind parapet, up to 30 degrees.
Chimneys	Commonly symmetrically placed, generally multiple.
Eaves	Narrow eaves, heavily decorated parapets and deep cornices.
Verandah	Generally included concave or bull nosed corrugated galvanised iron roof to verandah, often to both floors on double storey residences. Verandah roof separate to main roof.
Facade Form	Some arcaded verandahs and some projecting bay windows.
Windows	Double hung, sometimes with sidelights of varying vertical proportions.
Doors	Four or six panels with basalt threshold for outside doors.
Gutters	Ogee profile galvanised iron with timber mould below.
Fence	Fence types include cast iron palisade, timber picket and corrugated galvanised iron (for side fence) or hedges.
Other	Single and double storey with single storey forms often similar in height to earlier double storey dwellings due to their parapet height and higher ceilings.

Ornamentation

Roof	Cast iron cresting and finials sometimes used.
Eaves	Panelled entablature to eaves on front facade.
Chimneys	Heavy corbelling and cement render cornices to face brick or rendered brick chimneys with shaft decoration.
Parapets	Stucco, moulds, brackets, scrolls, balusters, shell motifs, urns, balls and acroteria.
Verandahs	Cast iron friezes. Cast-iron columns with fluted or decorated shafts, floral cast-iron lacework and masonry arcading (cast-iron lacework was made locally and so new designs were quite frequent).
Window/door framing	Window head moulding (occasionally attached spiral pilasters) and heavy door panelling.
Glazing	Etched and coloured glass to door sidelights and occasionally some leadlight windows to main rooms.

Proportions

Facade Composition	Similar to mid-Victorian period but with the forms standing out more boldly.
Openings	Vertical rectangles, generally symmetrically arranged.
Siting and Plan Form	Generally setback from street alignment to various degrees, with some groups of dwellings of uniform setback; terraces, semi-detached and detached examples. Plan form as for mid-late Victorian period.

v) Edwardian (1900s to 1910s)

ITEM	DESCRIPTION
------	-------------

Materials / Colours

Roof	Terra-cotta 'Marseilles' tiles for brick dwellings or corrugated galvanised iron or slate.
Walls	Pressed red face brick (decorative moulded bricks also available), tuck pointing; rough cast render as bands and to gable ends. Half timber gable ends or square edged timber weather-boards often with notched patterns to resemble shingles. Brick work usually cavity brick.
Verandah Floor	Timber verandah floor, occasionally tiles.
Colours	Cream, yellow ochre, reds, dark brown, with dark and softer green trims.

Elements

Roof Form	High, 30 to 40 degree pitch, asymmetrical roof form. In larger houses roof forms became more complex with the provision of steep roof planes and an array of gables, vents, dormer windows, turrets and spires projecting through the roof.
Chimneys	Assymmetrically placed, tall, ornate and brick.
Eaves	Narrow or with exposed rafters and lining boards.
Verandah	Low verandahs often extend from the main roof, clad in tiles.
Facade Form	Gabled windows project at right angles with square or oblong upper lights with obscure pattern glazing in pastel shades or leaded coloured glass patterns. Bay windows or curved square double hung sash windows and circular windows to principle rooms.
Doors	Three or four panels. Narrow vertical panels with large (often gabled) top panel.
Gutters	Ogee or later quadrant profile galvanised iron.
Fence	Fence types include timber picket, woven wire, chain link mesh, corrugated galvanised iron (for side fences) or hedges.

Ornamentation

Roof	Terra-cotta roof ridge capping and finials including dragons. On larger houses, towers and spires often came out of the roof covered with terra-cotta tiles. Decorative gable ends, often with pressed metal or roughcast infill panels and timber valances. Half timbering to gable ends.
Eaves	Timber fretwork sometimes.
Chimneys	Red brick chimney with brick or stucco banding and stucco ornamentation; often tall with capping blocks and chimney pots.
Parapets	Rarely used, sometimes at rear or side. Turned timber posts, elaborate timber fretwork, friezes and valances with little iron used. Hoods to window openings.
Verandahs	Leadlight to principle rooms.
Openings	Vertical and horizontal rectangles, often in an asymmetrical arrangement.
Siting and Plan Form	Generally setback from street to various degrees. Generally semi-detached and detached; some groups of semi-detached dwellings of uniform setback.

vi) Californian Bungalow (1920s)

ITEM	DESCRIPTION
<i>Materials / Colours</i>	
Roof	Terra-cotta or coloured concrete tiles.
Walls	Red brick, rough cast render detailing. Occasional pebble dash finish to verandah piers. Timber shingles to gables over bay windows.
Verandah Floor	Timber.
Colours	Woodwork/weather boards: brown, ivory and green (a popular colour)
Elements	
Roof Form	20 to 30 degree pitch, large gable ends, (perhaps with porch roof form a minimum 15 degree pitch); low, wide over hung roof.
Chimneys	Generally one large chimney, either to front or side elevation, assymmetrically placed.
Eaves	Overhanging (450mm) rafters exposed below gutter line.
Verandah	Deep verandahs with heavy pilons as supports.
Facade Form	One room forward generally.
Windows	Casement/double hung. Sometimes a simple bay window to main room. Diamond paneled leadlight on upper sashes of windows often to either side of chimney.
Doors	Often glazed.
Fence	Fence types woven and cyclone wire mesh with timber posts, brick, rendered masonry, timber picket or hedges.
Ornamentation	
Roof	Simple form with gabled ends.
Eaves	Deep barge boards with projecting rafters.
Chimneys	Little or no corbelling.
Parapets	Nil
Verandahs	Heavy tapered pylons with brick or rendered capping to verandah wall.
Window/door frames	Simple framing.
Note	A more restrained approach than earlier eras.

Proportions

Facade	Informal horizontal rectangles with a simple triangular roof form.
Siting and Plan Form	Setback significantly from the street alignment, to a fairly uniform degree in each street. Generally detached. Always asymmetrical plan form but with strong central facade element and central hall component.

vii) Spanish Mission (Late 1920s to Early 1930s)

ITEM	DESCRIPTION
<i>Materials / Colours</i>	
Roof	Cordova or Marseilles pattern terra-cotta tiles.
Walls	Stucco, sometimes with a parge effect
Verandah Floor	Tiled verandah floor.
Colours	Off white, yellow ochre, terra-cotta, salmon pink, beige and dark brown.
Elements	
Roof Form	20 to 30 degree pitch.
Chimneys	Assymmetrically placed, generally to side elevation and capped with cordova tiles.
Eaves	Boxed eaves.
Verandah	Parapet with a scrolled edge, arch opening with intermediate columns.
Facade Form	Planer front rooms and verandah.
Windows	Double hung curved heads.
Fence	Fence types include woven and cyclone wire mesh with timber posts, brick, rendered masonry, timber picket or hedges.
Ornamentation	
Roof	Cordova tiled ridges.
Eaves	Nil.
Chimneys	Tile Caps.
Parapets	Scrolled edge.
Verandahs	Baroque style intermediate columns.
Window/door frames	Plain framing with black wrought iron grilles sometimes.
Glazing	Sometimes bevelled edge glazing.
Other	Decorative lanterns sometimes.
Proportions	
Siting and Plan Form	Setback a considerable distance from the street alignment but to a fairly uniform degree in each street. Generally detached villas. Generally asymmetrical plan form with strong facade elements. Also apartment blocks.

GLOSSARY

of terms

Arcade	A range of arches carried on piers or columns, either freestanding or blind, i.e., attached to a wall.
Architrave	The lowest of the three main parts of an entablature; also more loosely, the moulded frame surrounding a door or window (if this frame turns away at the top at right angles, rises vertically and returns horizontally, it is called a shouldered architrave).
Ashlar	Hewn blocks of masonry wrought to even faces and square edges and laid in horizontal courses with vertical joints, as opposed to rubble or unhewn stone straight from the quarry.
Attic Storey	The space within the sloping roof of a house or the upper storey of a building if less high than the other floors.
Balcony	A platform projecting from a wall, enclosed by a railing or balustrade, supported on brackets or columns or cantilevered out.
Balustrade	A short post or pillar in a series supporting a rail or coping and thus forming a balustrade.
Barge board	A board fixed to the verge of a pitched roof.
Bay	A vertical division of the exterior or interior of a building.
Bay window	An angular or curved projection of a house front filled by fenestration. If curved, also called a bow window. If on an upper floor only, called an oriel or oriel window.
Bead moulding	A small cylindrical moulding enriched with ornament resembling a string of beads; used in the Romanesque period.
Blocking course	In classical architecture, the plain course of stone surmounting the cornice at the top of a building. Also a projecting cornice of stone or brick at the base of a building.
Bolection Moulding	A moulding used to cover the joint between two members with different surface levels. It projects beyond both surfaces.
Bracket	A small opening supporting a piece of stone or other material, often formed of scrolls or volutes, to carry a projecting weight.

Bressumer	A massive horizontal beam, sometimes carved, spanning a wide opening such as a fireplace. Also the principal horizontal rail in a timber-framed house.
Brickwork	A header is a brick laid so that the end only appears on the face of the wall, while a stretcher is a brick laid so that the side only appears on the face of the wall.
Bungalow	A single storey house.
Capital	The head or crowning feature of a column.
Casement window	A metal or timber window with the sash hung vertically and opening outwards or inwards.
Cast iron	A hard alloy of iron, carbon and silicon cast in a mould.
Chimney shaft	A high chimney with only one flue.
Chimney stack	Masonry or brickwork containing several flues, projecting above the roof and terminating in chimney pots.
Column	An upright member, circular in plan and usually slightly tapering; in classical architecture it consists base, shaft and capital. It is designed to carry an entablature or other load, but is also used ornamentally in isolation.
Coping	A capping or covering to a wall, either flat or sloping to throw off water.
Corbel	A projecting block, usually of masonry, supporting a beam or other horizontal member.
Corbelling	Brick or masonry courses, each built out beyond the one below. A common device on the brickwork of Edwardian chimneys.
Cornice	In classical architecture, the top, projecting section of an entablature; also any projecting ornamental moulding along the top of a building, wall or arch, finishing or crowning it.
Cresting	An ornamental finish along the top of a screen, wall or roof; usually decorated and sometimes perforated.
Dormer window	A window placed vertically in a sloping roof and with a roof of its own. The name derives from the fact that it usually serves sleeping quarters.
Eaves	The part of a roof which overhangs beyond the line of the wall.
Encaustic Tiles	Earthenware flooring tiles that are glazed and decorated, commonly used in the late Victorian period.

Etched glass and Patterned clear glass	Patterned clear glass common in the early and mid Victorian periods.
Fascia	A dressed timber member fixed at the end of a roof rafter that usually supports a gutter.
Fenestration	The arrangement of windows in a building.
Finial	Ornament applied to the apex of a roof, pediment or gable.
Fluting	Shallow, concave grooves running vertically on the shaft of a column, pilaster, or other surface.
French doors/windows	A long window reaching to floor level and opening in like a pair of doors.
Frieze	The middle division of an entablature, between the architrave and cornice; usually decorated but may be plain or the decorated band along the upper part of an internal wall, immediately below the cornice.
Gable	The triangular upper portion of a wall at the end of a pitched roof. It is sometimes finished with a decorated barge board or rough cast render.
Graining	The imitation of natural woodgrain involving the application of a light undercoat and then a darker paint and varnish.
Half timber (also Nogging)	A method of construction where walls are built of timber framework with the spaces filled in by plaster or brickwork (known as nogging). Sometimes the timber is covered with plaster or boarding laid horizontally.
Leadlight	A window having small panes of clear, coloured or painted glass connected with strips of lead.
Mouldings	The contours given to projecting members.
Nogging	See Half timber.
Mullion	A vertical post or other upright dividing a window or other opening into two or more lights.
Ogee	A double-curved line made up of a convex and a concave part, resembling an "s" shape.
Oriel	See Bay window.
Palisade	A fence of pales or of iron railings.

Parapet	The extension of a wall above what would otherwise be the eaves line. Common in Victorian architecture, usually between 500 and 1500mm in height and decorated with ornamentation such as moulded cornices, pediments and nameplates.
Pediment	Derived from Greek architecture. An element used in Victorian architecture ornamentally over doors or windows, or surmounting a parapet, usually triangular or curved in shape.
Pier	A solid masonry support, as distinct from a column. The solid mass between doors, windows, and other openings in buildings. A name often given to Romanesque and Gothic pillars varying from a square to a composite section.
Pilaster	A shadow pier or rectangular column projecting only slightly from a wall.
Pillar	A free standing upright member which, unlike a column, does not need to be cylindrical or conform with any of the classical orders.
Plinth	The projecting base of a wall or column pedestal, generally chamfered or moulded at the top.
Pointing	In brickwork, the strong mortar finishing given to the exterior of the joints.
Polychromatic brickwork	Exposed brickwork in at least three colours ranging from creams to terra-cotta to dark brown and combined to form bold patterns, usually on the public facade of the building.
Quoins	A stone or brick used to reinforce or decoratively distinguish an external corner edge of a wall from adjacent masonry.
Render	The plastering of an outer wall.
Ridge	The horizontal line formed by the junction of two sloping surfaces of a roof.
Roughcast	An external rendering, the top coat of which contains gravel, crushed stone or pebbles.
Sash window/ double hung window	A window formed with sashes, ie sliding glazed frames running in vertical grooves; imported from Holland into England in the late C17.
Shingles	Wooden tiles for covering roofs and spires.

Sill	The lower horizontal part of a window frame
Soffit	The underside of any architectural element.
String Course	A continuous projecting horizontal band set in the surface of an exterior wall and usually moulded.
Stucco	Plasterwork.
Tessellated	Tiles of different shapes, sizes and colours laid on a path, verandah or floor to form a mosaic pattern.
Tuckpointed	A method of finishing the joints between face brickwork in which mortar coloured to match the brick is used and onto which a lime putty bead is run to form a crisp white delineation of the bonding of the brickwork.
Verandah	An open gallery or balcony with a roof supported by light (usually metal) supports.
Weatherboard	Overlapping horizontal boards covering a timber framed wall, the boards are wedge shaped in section, the upper edge being thinner.

BIBLIOGRAPHY

City of Port Phillip:

City of Port Phillip.
Port Phillip Planning Scheme.
City of Port Phillip.

Ward, Andrew.
Port Phillip Heritage Review.
City of Port Phillip, 1998

Urban Initiatives P/L & Environment and Land Management P/L
& Panta Rhei Information Technology.
Port Phillip Urban Character Study.
City of Port Phillip, 1998.

Jacobs Lewis Vines.
Port Melbourne Conservation Study.
City of Port Melbourne, 1979

Allom Lovell and Associates.
Port Melbourne Conservation Study Review.
City of Port Phillip, 1995.

Nigel Lewis & Associates, Bick, David, Wilson Sayer Core P/L
St Kilda Conservation Study, Area 1 and Area 2.
City of St Kilda, 1982 and 1985.

Peck Von Hartel Trethowan and Henshall Hansen Associates.
St Kilda Twentieth Century Architectural Study.
City of St Kilda, 1992.

City of Port Phillip
*Design and Development Guidelines for the Conservation of
Garden City.*
City of Port Phillip, 1987.

Other:

Apperley, Richard, et al.
A Pictorial Guide to Identifying Australian Architecture.
Angus and Robertson, Melbourne, 1989.

Butler, Graeme.
The Californian Bungalow.
Lothian Books, Port Melbourne, 1992.

Cuffley, Peter.
Australian Houses of the '20s and '30s.
The Five Mile Press, Sydney, 1989.

Evans, Ian.
Caring for Old Houses.
The Flannel Flower Press, Sydney, 1990.

Evans, Ian, Lucas, Clive and Stapelton, Ian.
Colour Schemes for Old Australian Houses.
The Flannel Flower Press, Sydney, 1984.

Evans, Ian
Restoring Old Houses
Macmillan, Melbourne, 1979.

Evans, Ian
The Federation House
The Flannel Flower Press, Sydney, 1986.

Fraser, Hugh and Joyce, Ray.
The Federation House Australia's Own Style.
Lansdowne Press, Sydney, 1986.

Historic Buildings Council.
Caring for Historic Buildings - Guidelines for Alterations and Additions to Historic Buildings.
Public Affairs Branch Department of Planning and Development, Melbourne, 1993.

Latrielle A, Latrielle P and Lovell P.
New Uses for Old Buildings in Australia.
Australian Council of National Trusts, Canberra, 1982.

Raworth, Bryce.
Our Inter-War Houses.
National Trust of Australia (Victoria), Melbourne, 1991

Stapleton, Ian.
How to Restore the Old Aussie House.
J. Fairfax Marketing, Sydney, 1983.

Tanner, Howard and Cox, Phillip.
Restoring Old Australian Houses and Buildings.
Macmillan, Melbourne, 1975.



Garden City Estate Guidelines

Revised Feb 2021



This page has been intentionally left blank

Cover image: Nearmap (Aerial photo taken April 2019).

Contents

Introduction

Purpose	4
Application	4
How to use the Guidelines	4

Guideline Basis

The significance of Garden City Estate	6
--	---

Guideline 1: Conservation

Roof guidelines	10
External walls and surfaces guidelines	10
Windows and doors guidelines	11
External decoration guidelines	12

Guideline 2: Alterations & Additions

Guidelines for single storey additions	14
Guidelines for two storey additions	15
Guidelines for alterations	16

Guideline 3: New Buildings

Guidelines	18
------------	----

Guideline 4: Car Parking

Guidelines	20
------------	----

Guideline 5: Fencing

Guidelines	23
------------	----

Guideline 6: Public Realm & Infrastructure

Guidelines	27
------------	----

Guideline 7: Subdivision

Guidelines	29
------------	----

Purpose

The Garden City Estate is a significant heritage place. It is essential that the City of Port Phillip and its residents maintain and enhance its unique character. It is also important that the needs of individual property owners are recognised. These guidelines are designed to strike a balance between these objectives. They describe the features that make the Garden City Estate significant and offer practical suggestions to help property owners maintain its significance, whilst allowing for renovations and development to occur.

The guidelines were initially prepared in 1997 and updated in 2010 and 2020. This version has been prepared to ensure alignment with updated heritage policy at Clause 15.03-1L of the Port Phillip Planning Scheme and the City of Port Phillip Heritage Design Guidelines (Background Document listed at clause 72.08 of the scheme).

Application

The guidelines apply to all land included in the Garden City Estate (also known as Bank House Estate). The area is bounded by the lane west of Graham Street, Williamstown Road, Howe Parade, Poolman Street and Walter Street at Port Melbourne (see Figure 1).

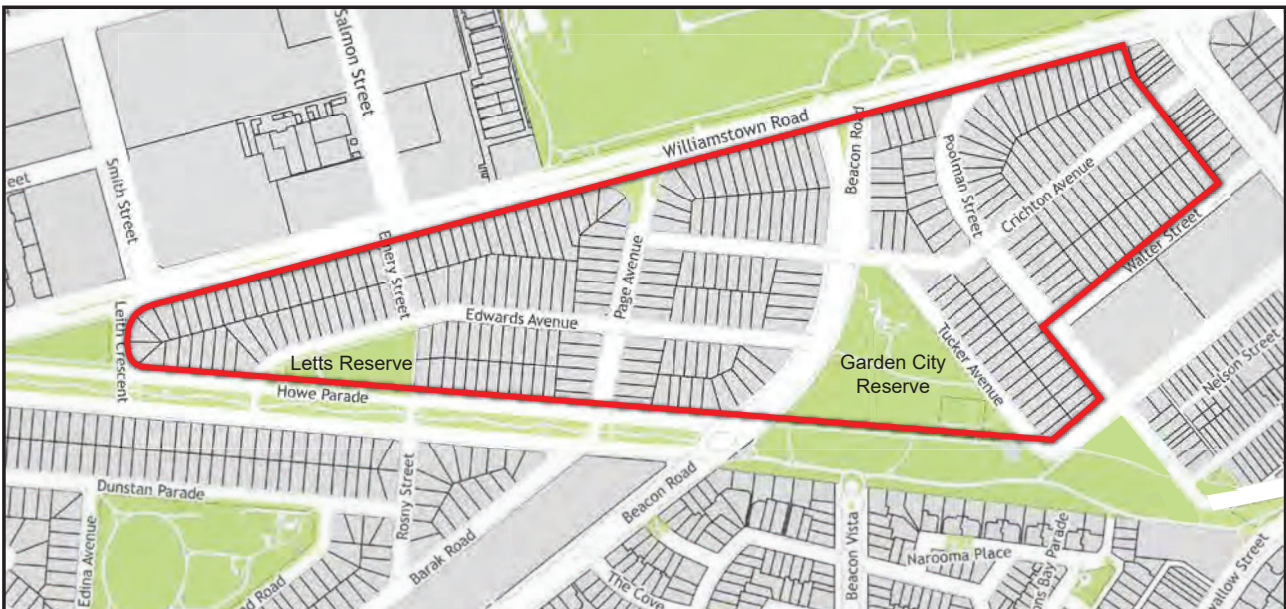

Figure 1. The Garden City Estate boundary shown in red

The area contains 322 dwellings, which were constructed for the State Savings Bank of Victoria between 1926 and 1948. The dwellings are built in pairs to six standard designs. The Garden City Estate also includes several recreational reserves.

How to use the Guidelines

The guidelines explain what Council will take into consideration when assessing a planning permit application for development or subdivision of land in accordance with Clause 43.01 Heritage Overlay of the Port Phillip Planning Scheme.

The guidelines should be considered in conjunction with State and local heritage policy at Clause 15.03 of the Port Phillip Planning Scheme, and the City of Port Phillip Heritage Design Guidelines.

In the event of any inconsistency between the guidelines and the City of Port Phillip Heritage Design Guidelines, these guidelines should be used for applications within the Garden City Estate.

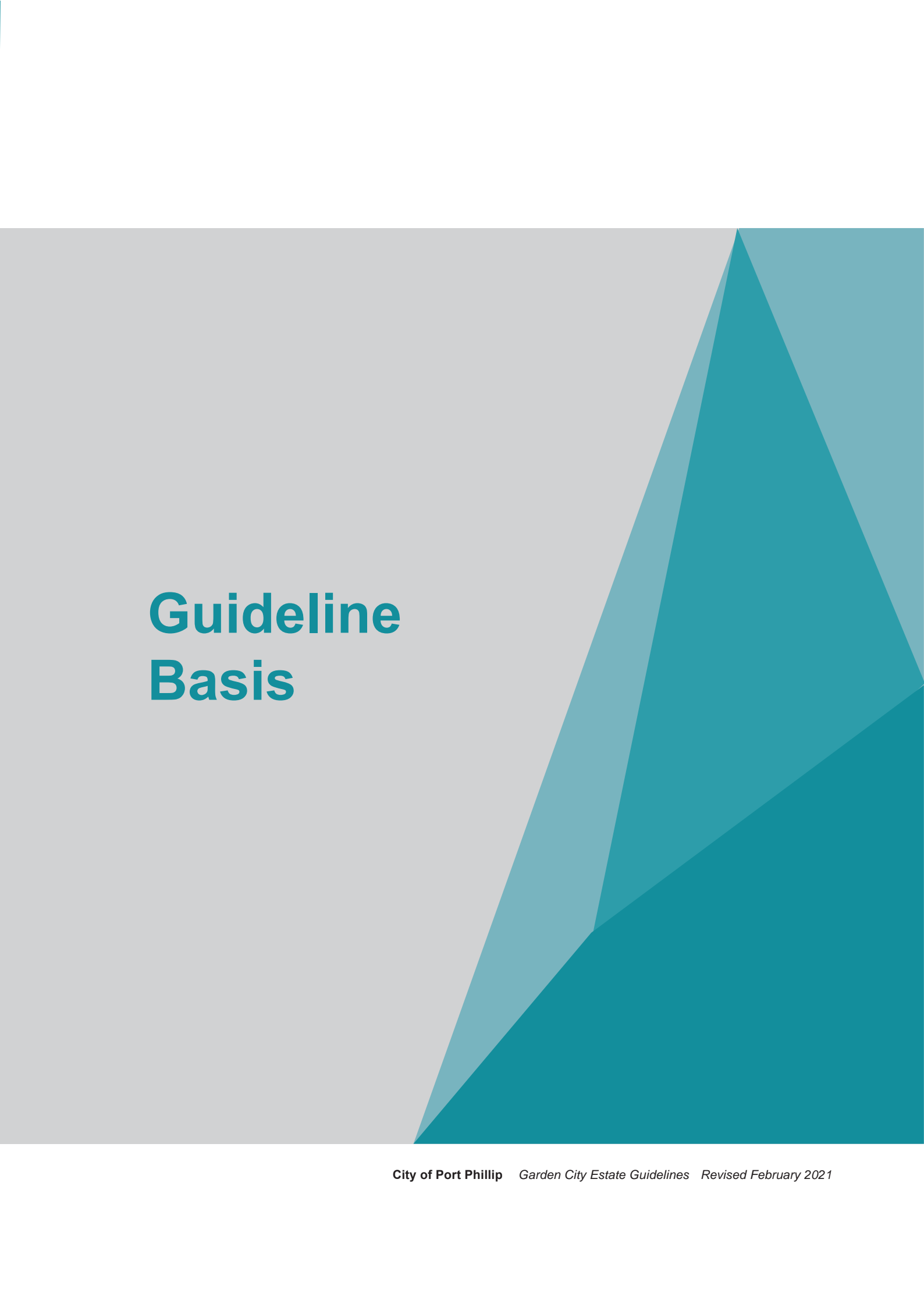
The background features a large, abstract geometric composition. On the right side, there are several overlapping triangular shapes in various shades of teal and blue, pointing towards the top right. The left side of the page is a solid, light grey color. The text 'Guideline Basis' is positioned on the left, overlapping the grey area.

Guideline Basis

The significance of Garden City Estate

The Garden City Estate is of local heritage significance and is included within the heritage overlay of the Port Phillip Planning Scheme as part of HO2 The Garden City Housing Estates heritage precinct. The HO2 precinct comprises the three garden city estates, including Fishermans Bend Estate, the Garden City (Bank House) Estate and the Dunstan Estate.

The Garden City Estate was a unique experiment in mass housing, quite unlike anything else in Australia. Initiated by the State government through the State Savings Bank, it was Victoria's first attempt to provide low-cost housing on a single estate. Garden City Estate was influential on later State public housing policies as implemented through the Housing Commission of Victoria and the construction of many other public housing estates around the State.

The Garden City Estate was originally recognised as an area of special heritage significance in the Port Melbourne Conservation Study (1979) commissioned by the former Port Melbourne City Council and the Australian Heritage Commission. Garden City Estate was also classified by the National Trust of Australia (Victoria) in 1987. In 1995 Port Phillip City Council reaffirmed the significance of the Estate through the Port Melbourne Conservation Study Review (1995) and in 2000 recognised the estate as Significant on the Heritage Policy Map within the Port Phillip Planning Scheme.

Both the conservation study review and the National Trust classification report conclude that Garden City Estate is an area of State (and probably national) significance due to its:

- Contribution to the development of public housing policies and practices in Australia;
- Integrity and uniqueness as a residential environment;
- Relationship to the Garden City movement in Britain;
- Experimental building technology, residential planning and streetscape design.

Garden City Estate owes its special character to the unusual combination of social, administrative, planning and architectural factors that influenced its development over more than two decades. The consistent application of a single development philosophy over such a long period is unusual in itself. The layout of the sites and the design and orientation of the dwellings express the vision policy-makers had of working-class housing during the inter-war years. They also tell us much about the tastes and lifestyles of the time.

Standard house designs

The estate was designed according to the Garden City town planning philosophy popular in England earlier this century. The housing style within the estate and the general layout of the estate were extremely innovative for their time and were very different from the typical housing developments of the 1920s and 1930s. Figure 2 below provides a pictorial description of the six standard housing designs found within Garden City.



Type 1 Standard housing design



Type 2 Standard housing design



Type 3 Standard housing design



Type 4 Standard housing design



Type 5 Standard housing design



Type 6 Standard housing design

Figure 2. The six standard house designs

Important features

The most important feature of Garden City (Bank House Estate) is the uniform character of the streetscape.

In Garden City, the main streetscape elements are the dwellings, which are all two storey, attached houses on sites with a similar front and side setback. The consistent and prominent use of features like unglazed terracotta roof tiles, stucco walls (both rough-cast and smooth), woven wire fences and multi-paned windows contribute to the area's distinctive streetscape character.

The use of concrete for paving roads, footpaths and garden paths is another unifying aspect of the streetscape, as is the regular planting of only a few selected species of vegetation.

Most residential areas combine many different (and sometimes incompatible) approaches to design. In the case of Garden City, faithful adherence to a single design theme has produced an unusually harmonious and integrated urban environment – this is the key to the area's architectural and aesthetic significance. Figure 3 shows the important key features of the Garden City streetscape.

- ① Houses as semi-detached pairs with clear separation
- ② Consistent window, eave and porch details
- ③ Consistent stucco finishes
- ④ Wide eaves
- ⑤ Hipped, tiled roofs with chimneys
- ⑥ Regular tree planting at property boundaries
- ⑦ Grass nature strips
- ⑧ Concrete roads, kerbs, channels and crossovers
- ⑨ Transparent fences and gates

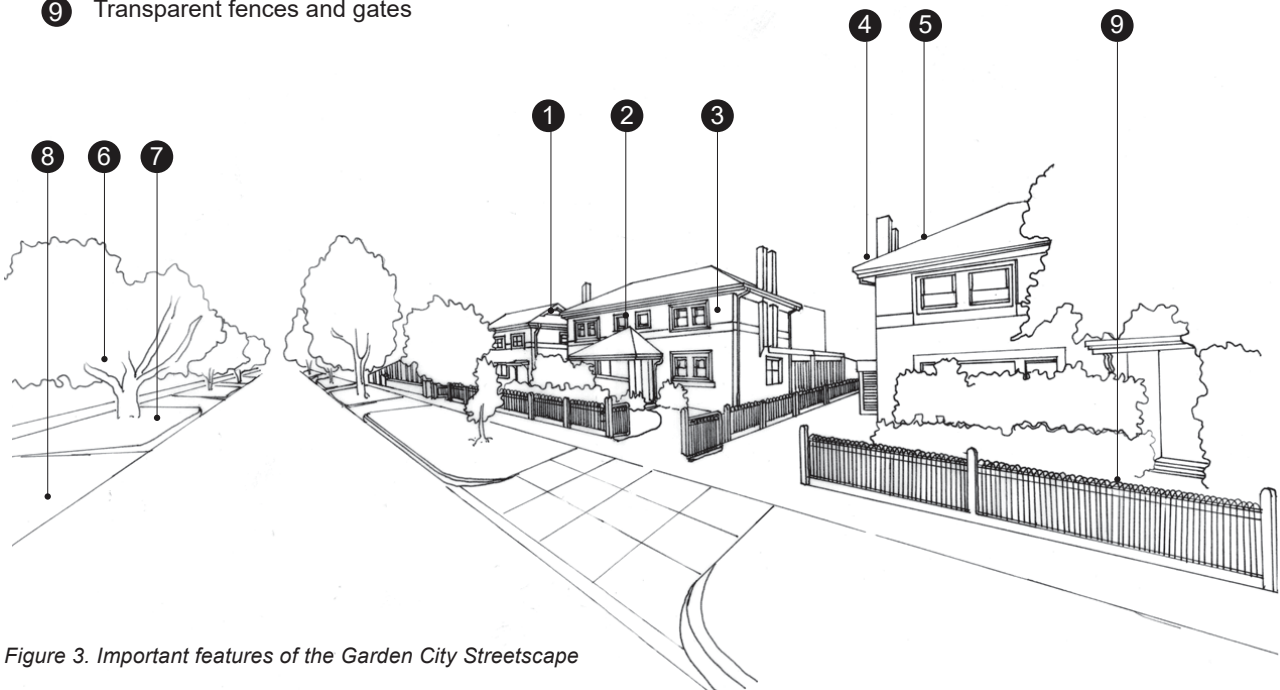
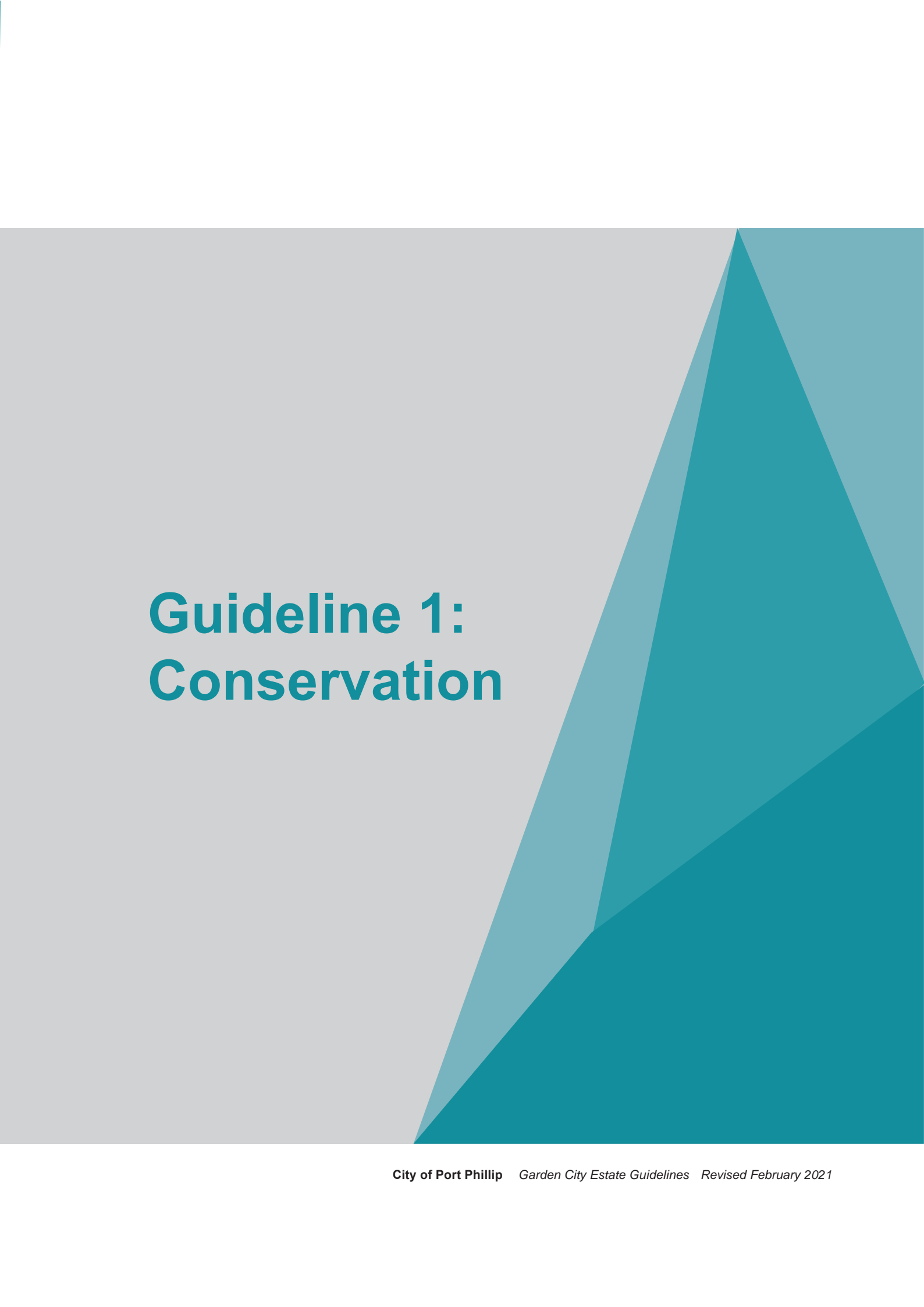

Figure 3. Important features of the Garden City Streetscape

The background features a light grey gradient on the left side, transitioning into a series of overlapping teal-colored geometric shapes on the right. These shapes include a large triangle pointing upwards and several overlapping trapezoidal and triangular forms in various shades of teal, creating a modern, layered effect.

Guideline 1: Conservation

Roof guidelines

The original roof form and materials should be retained and, if necessary, restored all the way along the front and side of the house.

Chimneys

- Original chimneys should be retained.

Downpipes

- Downpipes at the front of the house should be kept or returned to their original location where practical.
- Consideration will be given to removal or concealment of downpipes.

External walls and surfaces guidelines

- External walls which are visible from the street should be kept in their original form, with the original materials and finishes.
- Rendered surfaces should be restored by cleaning with an appropriate solution or by applying a cement-and-sand wash of the same colour and texture. The work should be undertaken by a qualified tradesperson.
- Repairs to rendered surfaces should match the colour, texture and composition of the original render.
- Rendered surfaces which have not been painted can be left unpainted or painted in colour matching the original render or cement.
- Rendered surface which have been painted should be restored where possible. Paint should be removed by an approved method (not sandblasting) and
- the surface should be treated with a cement-and-sand wash in the original colour (at least three different render colours were used on the estate).

Windows and doors guidelines

- Original windows and doors should be retained. If replacement is required, the new one should match the form and materials of the original.
- Double glazing of windows is permitted if it does not change the external appearance of the window.

Repairing cracked lintels

The lintels above many windows in Garden City are badly cracked. The cracking is usually caused by moisture seeping through the external skin of the building and corroding the steel reinforcing rods inside the lintel. It is worse on windows that face the weather (south and west). Windows on north and east facing walls and upper-storey windows protected by eaves are less likely to be affected.

- The best way to tackle severe cracking is to replace the lintel with a new one manufactured using dense concrete (at least 50Mpa). There should be at least 40mm of cover over the new lintel's steel reinforcing rods.
- Less seriously damaged lintels can be repaired using one of several patching systems. These involve removing the external concrete to expose the corroded reinforcing rods, treating the rods, concreting over them again, and restoring the external finish. This may seem like a cheaper option, but it is important to remember that patches typically last only about five years – replacing the lintel may be more economical in the long term.
- For more information about replacing lintels, it is recommended that you talk to a builder experienced in this field.

External decoration guidelines

- Window and door frames, fences, downpipes and gutters should be painted in the original colours, or a colour scheme typical of the area or the period. The original colours can usually be determined by scraping back to the wood one layer at a time. Figure 4 shows a range of possible colour schemes, although other schemes will be considered.
- Neighbours are encouraged to agree on one colour scheme for both houses in each pair.
- If the original natural stucco walls are already painted, either remove paint and apply cement wash, or repaint in Natural Grey.

- ① Gutter
- ② Fascia and scotia
- ③ Under eaves
- ④ Frame boxing
- ⑤ Sash
- ⑥ Sill
- ⑦ Bracket
- ⑧ Frame
- ⑨ Under canopy
- ⑩ Door and frame
- ⑪ Fence
- ⑫ Natural stucco walls (unpainted)

- a Dark trim**
 - Mid brunswick green
 - Leaf brown
 - Deep brunswick green
 - Deep indian red

- b Mid- range colour**
 - Biscuit
 - Deep buff

- c Light trim**
 - Off white
 - Cream
 - Manila

- d Natural grey**
 - Natural grey
 - Warm grey pale stone
 - Mid to light ochre

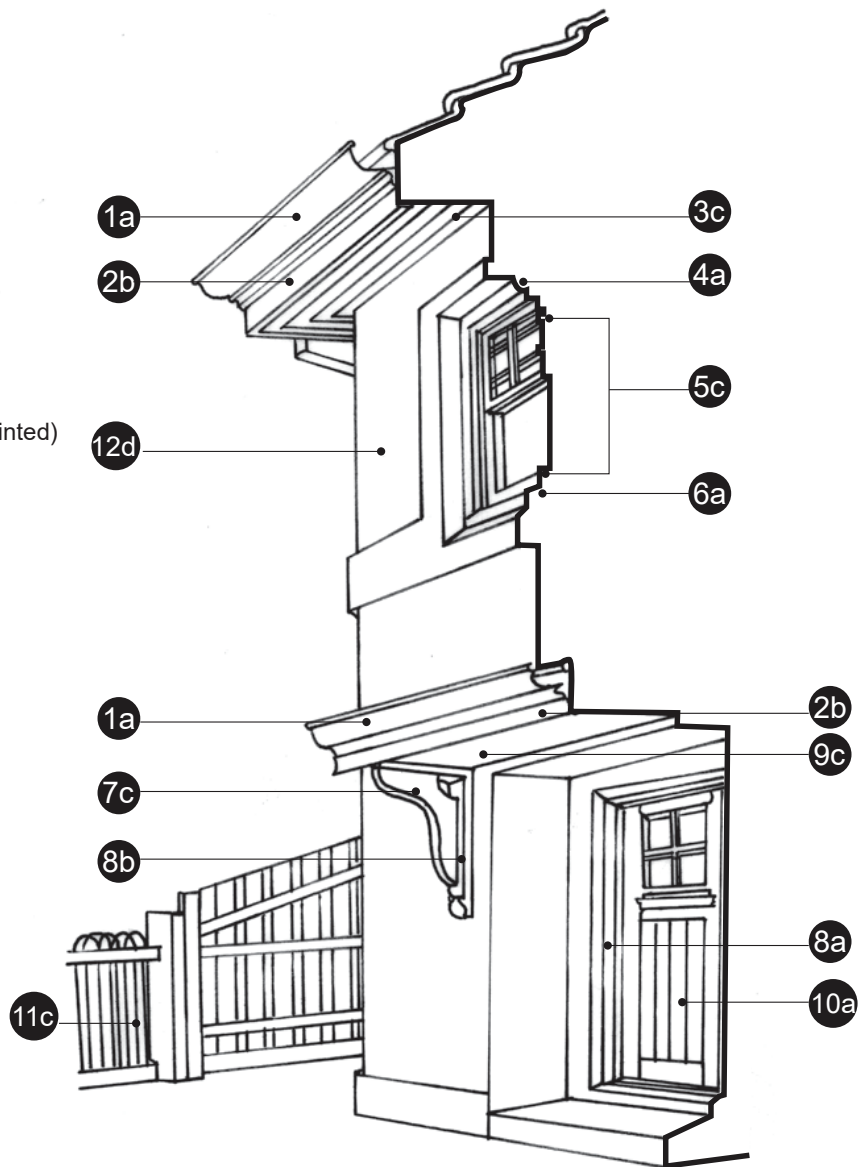
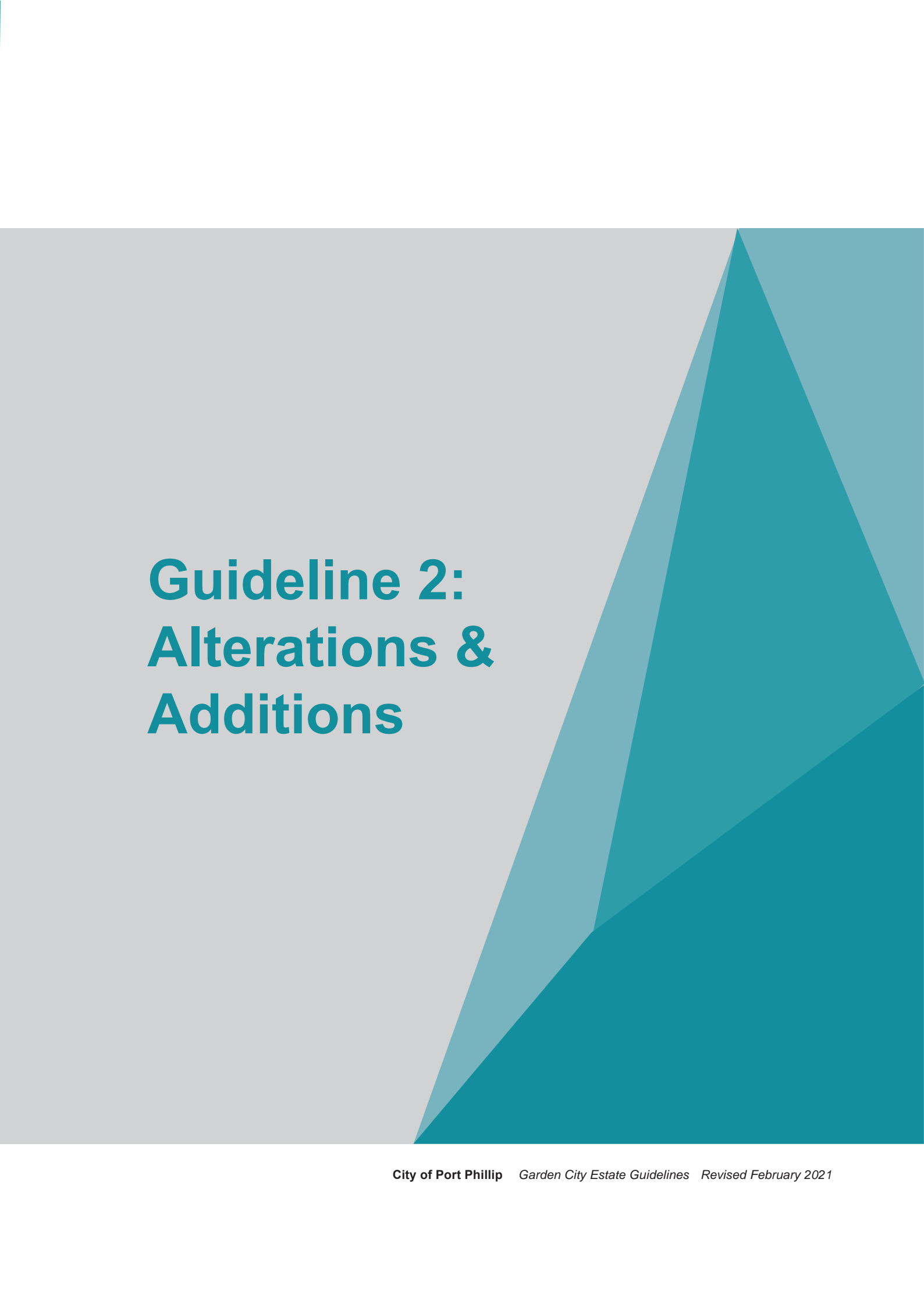

Figure 4. Facade articulations

The background features a large, abstract geometric design. On the right side, there is a large teal triangle pointing upwards, which overlaps with a lighter teal triangle. The left side of the page is a solid light grey color.

Guideline 2: Alterations & Additions

Guidelines for single storey additions

Single storey additions are permitted at the rear of the house.

Single-storey additions (refer to Figures 5 and 6) may be permitted at the side of the house if:

- They respect and complement the house's original form, materials and character;
- They are more than 600mm setback from the front of the house, or more if there are original windows in the side wall;
- The extended boundary wall is rendered consistent with the finish of the original house on corner sites.

Single storey additions will generally not be permitted in other areas.

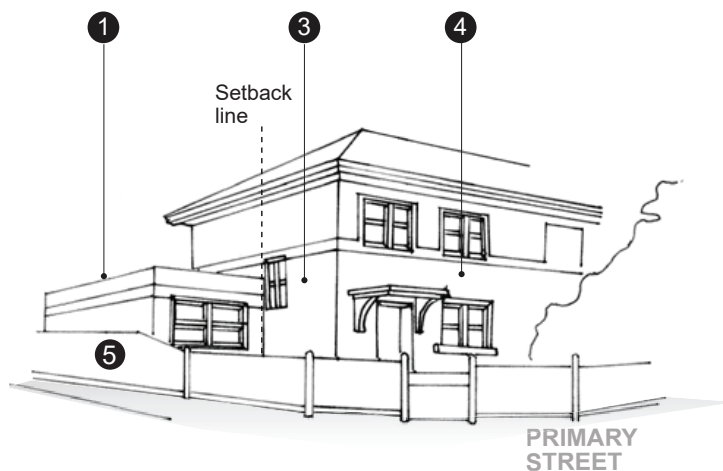

Figure 5. Single storey side addition in flat roof

- 1 Example consistent with original houses's material and details
- 2 Example matching house's hipped roof form
- 3 Setback from front of house
- 4 Front of house is the main wall and not any projecting bay or porch
- 5 Boundary wall of a corner block is rendered consistent with the finish of the original house

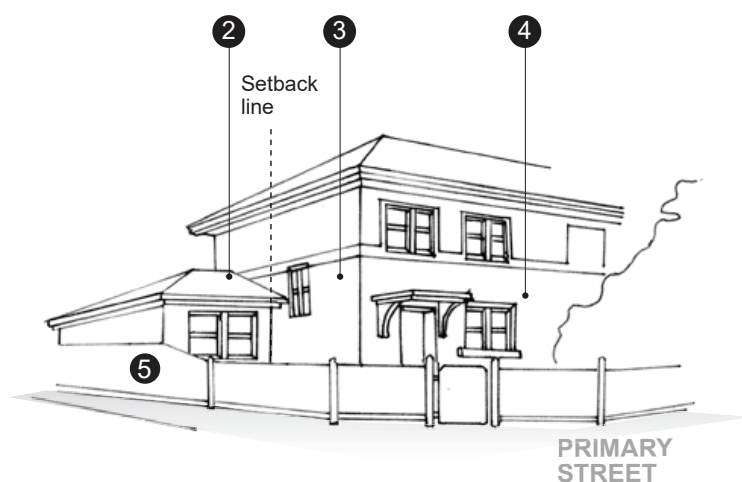

Figure 6. Single storey side addition in hipped roof

Guidelines for two storey additions

Two-storey additions are permitted at the back of the house if:

- The roof of the addition is no higher than the roof of the original dwelling;
- The walls of the addition are no higher than the walls of the original dwelling;
- The addition respects and complements the house's original form, materials and character (with a cement render or similar textured finish, and a flat or pitched roof with terracotta tiles); and

Two-storey additions will generally not be permitted in other areas, including the front of the house and the side of the house.



- 1 Two-storey extensions are not allowed at the side of the house. Carports and garages should be set back no less than 600mm from front front house
- 2 Keep two-storey extensions out of sight behind existing houses

Figure 7. Two storey additions to a building in Garden City.

Guidelines for alterations

Windows and doors

- New or enlarged window and door openings will not be permitted at the front of the house.
- Double glazing of windows is encouraged.
- Double glazing of windows is permitted if it does not change the external appearance of the window
- Refer to *Guideline 1 Conservation* for painting windows and doors.

Air conditioners

- Building services such as air conditioners should not be visible from the street.

Porches and entries

- Porches and entries may be enclosed with transparent screens that are at least 75 percent transparent or with plain glazing with the minimum of framing and glazing bars.
- New porches should not be located at the front of a house, or where it is visible from the street.

Blinds and awnings

- Sunblinds and awnings (temporary and permanent) should complement the character of the house.

Shutters

- Security screens may be installed, if they are
 - At the back of the house
 - At the side of the house and are more than halfway back from the front of the house
 - Inside the windows at the front of the house
- External screens and timber shutters over front windows are discouraged.

The background features a large, abstract geometric composition. On the right side, there are several overlapping triangles in various shades of teal, ranging from a light, almost white-blue to a deep, dark teal. These triangles point towards the top right corner. The left side of the page is a solid, light grey color. The text is positioned on the left side, overlapping the grey area.

Guideline 3: New Buildings

Guidelines

- Multi-unit development (more than one residential dwelling per lot) will not be permitted as this is contrary to the significance of the estate.
- Single-storey granny flats located at the rear of the property may be permitted.
- Any proposed granny flat must be sympathetic and consistent with these guidelines.

Guideline 4: Car Parking

Guidelines

- New garages and carports should be built at the side of the house and set back not less than 600mm from the front of the house, or more if there are original windows in the side wall.
- Garages should have cement render or similar textured finish walls, and a flat or hipped roof with terracotta tiles.
- Carports should be freestanding with a flat roof as shown in Figure 8. The space in front of a dwelling should be retained as lawn or garden and not used as a space to park vehicles.
- New garages and carports should be positioned to retain the original staggered line of houses along the street. (Refer to Figure 9)

- ① Gutter
- ② Scotia moulding
- ③ Timber fascia
- ④ Timber horizontal beam
- ⑤ Tray deck roofing
- a Nominal 2.55 meters
- b Nominal 2.865 meters and to align with porch height of house
- c Square timber posts or circular metal columns 250mm diameter
- d Maximum dimension 2.5 meters

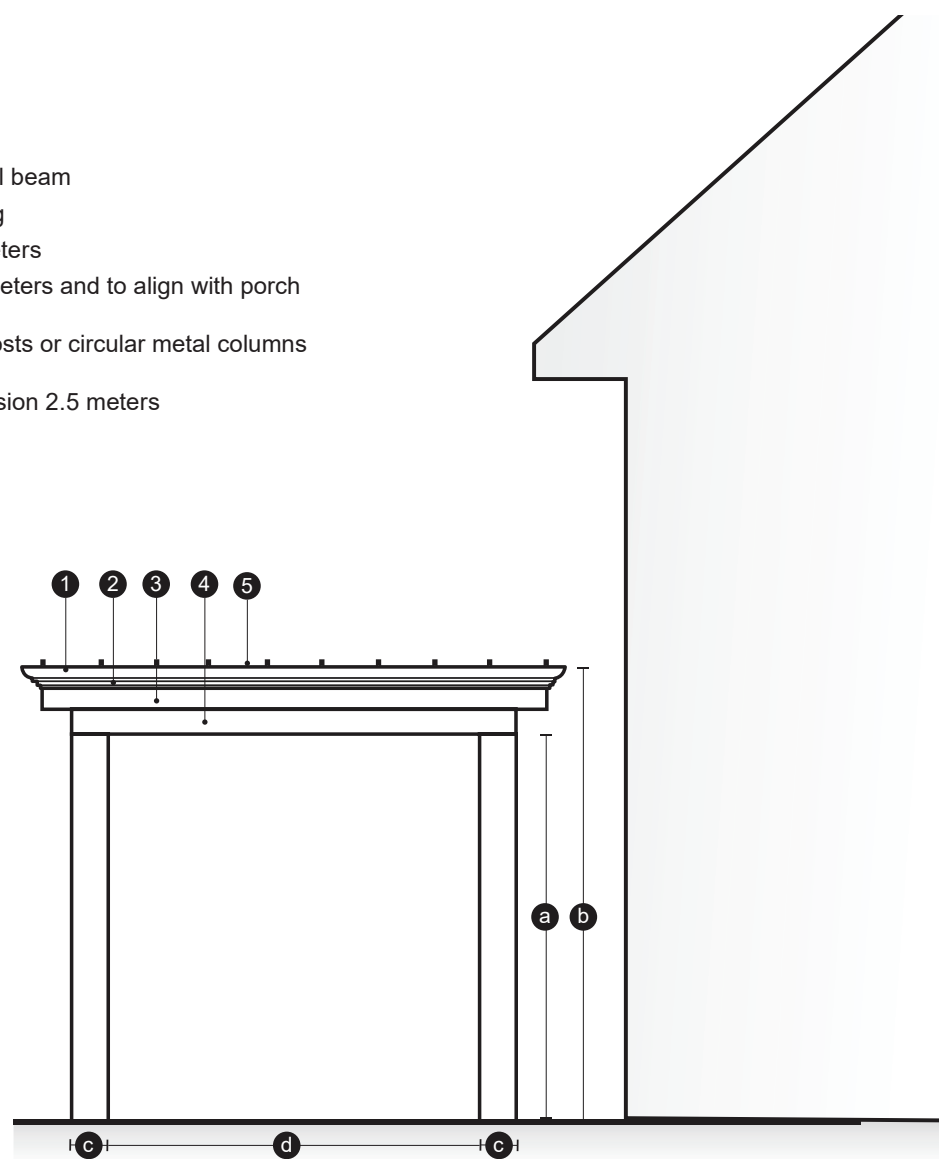

Figure 8. Acceptable garage and carport types - Carport with flat roof

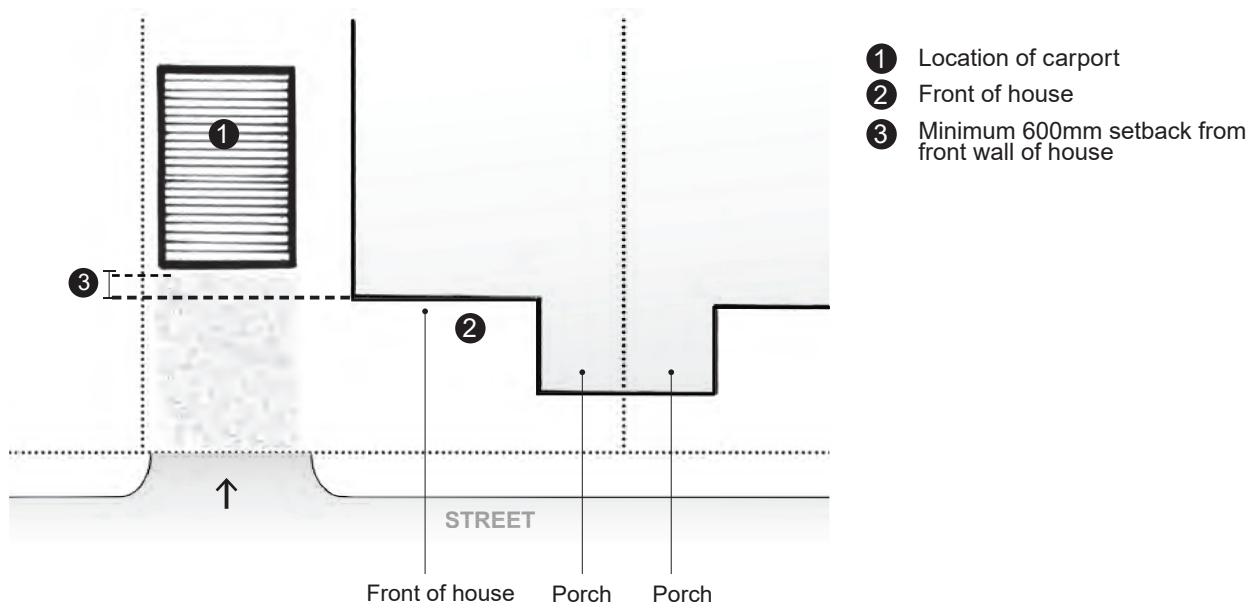

Figure 9. Acceptable garage and carport types - Site Plan

The background features a large, abstract geometric design. On the right side, there are several overlapping triangles in various shades of teal and blue. On the left side, there is a large, light grey trapezoidal shape that tapers towards the top right, meeting the teal shapes.

Guideline 5: Fencing

Guidelines

Front fences and side fences from the front boundary to front of the house (see Figure 10) should be:

- Woven wire as shown in Figure 11 or timber picket as shown in Figure 12.
- No more than 1 meter high if woven wire, and 900mm if timber picket.
- Minimum 75% transparent with exception of picket fences.

As shown in Figure 13, back fences and side fences from the front of the house to the back boundary should be

- No more than 2 metres high.
- Made from timber palings or other suitable materials as agreed between the neighbours.

Residents seeking more visual privacy are encouraged to use a combination of acceptable fencing and screen plantings such as hedges or bushes.

Refer to Guideline 9 for painting fences.

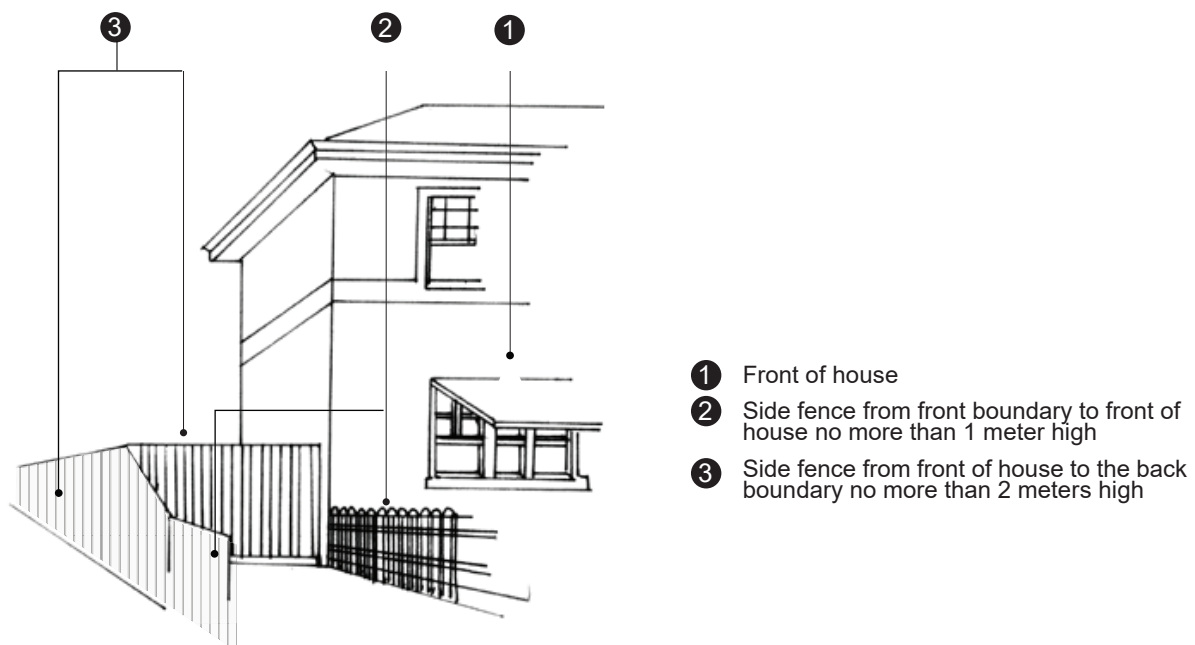

Figure 10. Front and side fence

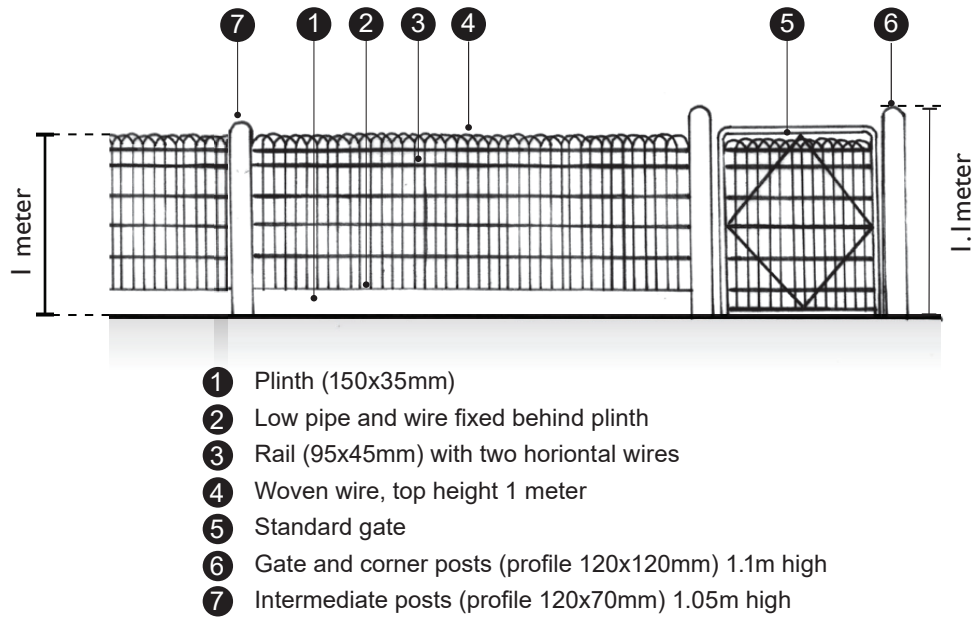

Figure 11: Woven wire fence

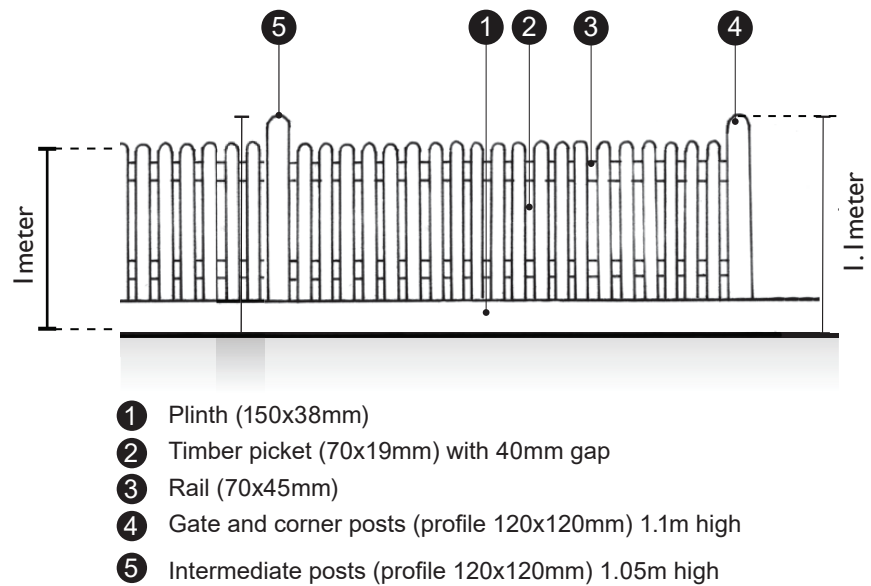
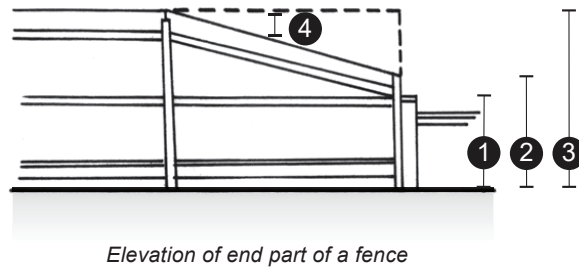

Figure 12: Picket timber fence

Fencing

- ① Gate post 950mm
- ② End post 1.35 m
- ③ Top of the fence 1.95 m
- ④ Optional splay



- ① Plinth (150 x 25mm)
- ② Straight
- ③ Alternative tops
- ④ Castellated
- ⑤ Sawn Palings
- ⑥ Posts (125 x 75mm)
- ⑦ HW rails (100 x 50mm)
- ⑧ Bottom rail 320mm
- ⑨ Middle rail 1.04m
- ⑩ Top rail 1.75m
- ⑪ Top of the fence 1.95m
- ⑫ Post spacing (2.4 - 2.7m)

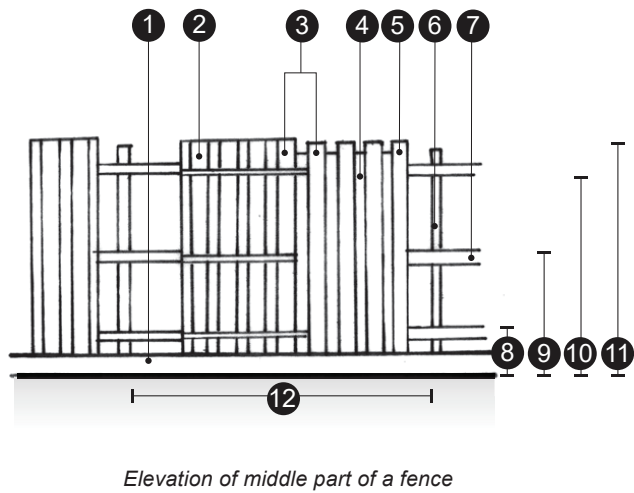

- ① Sawn Palings
- ② HW rails (100 x 50mm)
- ③ Posts (125 x 75mm)
- ④ Plinth (150 x 25mm)

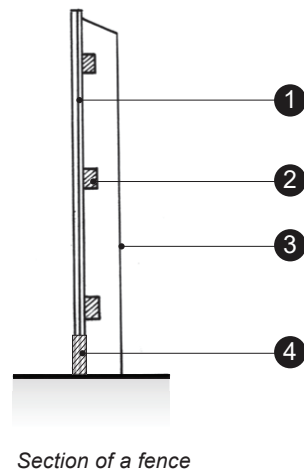
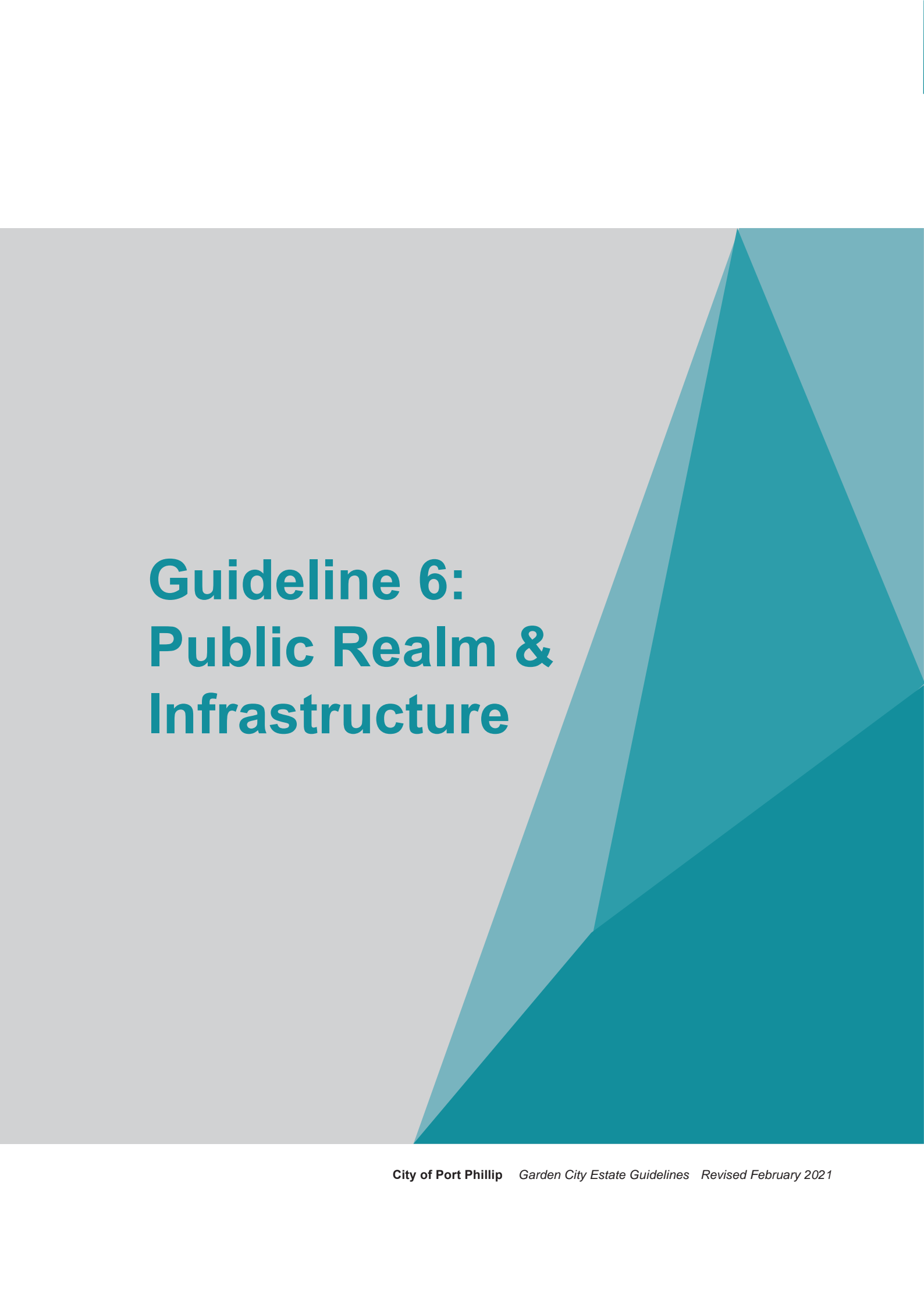

Figure 13: Side and rear fence

The background features a large, abstract geometric composition. On the right side, there are several overlapping triangles in various shades of teal and blue, pointing towards the top right. The left side of the page is a solid light grey color. The text is positioned on the left side, overlapping the grey area.

Guideline 6: Public Realm & Infrastructure

These guidelines apply to all works within the public realm in Garden City including:

- Roads and road surfaces;
- Kerbs and channels, footpaths and crossovers;
- Nature strips and parks.

Guidelines

- Works within the public realm should be designed to be consistent with the form and materials of the original works and kept within the original design and street layout, but to modern-day standards;
- Any new works which are not part of the original design (such as kerb extensions) should be consistent with the form and materials of comparable existing works within the estate;
- Speed humps should be constructed from asphalt;
- Roundabouts should not alter any original kerb lines;
- The original uniformity of street trees should be retained.



Guideline 7: Subdivision

Guidelines

- Subdivision of original lots is discouraged.

GARAGE AND/OR CARPORT STRUCTURES

The following guidelines offer design suggestions in relation to the siting and design of garage and/or carport structures.

Objective

Car parking structures should not dominate the development or street frontage and should contribute to the character of the streetscape.

Guidelines

If a roller door is proposed, it should be demonstrated by the applicant that it contributes to the character of the area and that the overhead drum enclosure is designed so as to be fully enclosed and screened from view from surrounding streets/laneways.

In a Heritage Overlay Area, hinged, horizontal sliding, concertina or panel lift garage doors are preferred, as they are generally complimentary to the main architectural styles predominant in Port Phillip.

Garage/carport structures should be located at least 1 metre behind the line of the front wall of the building (excluding projections such as verandahs, balconies and bay windows).



**City of Port Phillip
NEIGHBOURHOODS AND URBAN CHARACTER AREAS**

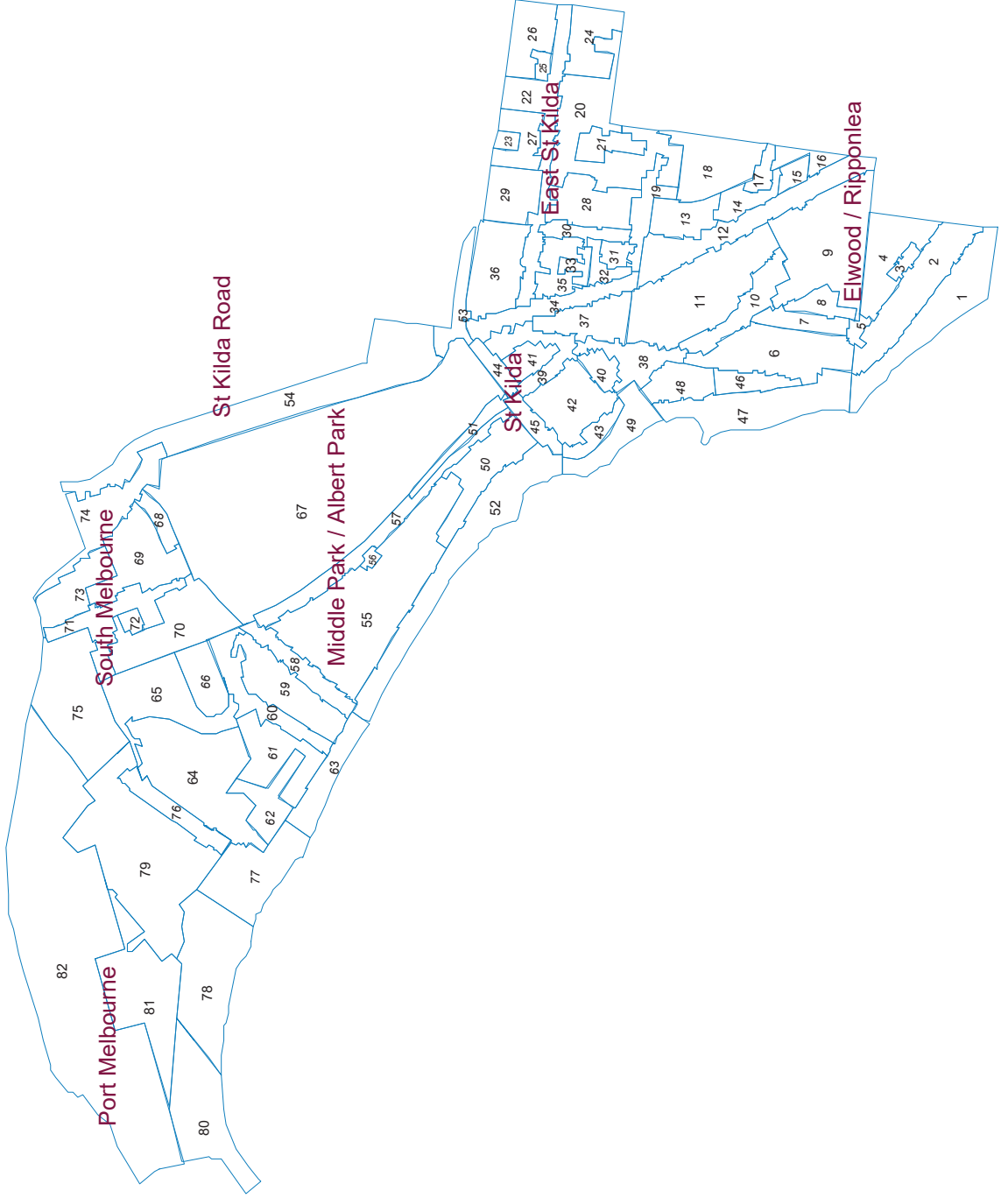



City of Port Phillip
URBAN CHARACTER DESCRIPTION

AREA 1: ORMOND ESPLANADE, ELWOOD

The following description should be used in carrying out the site analysis and design response to your site. Pay attention to the very important and important character elements listed here, as well as the actual conditions observed at the site analysis stage.

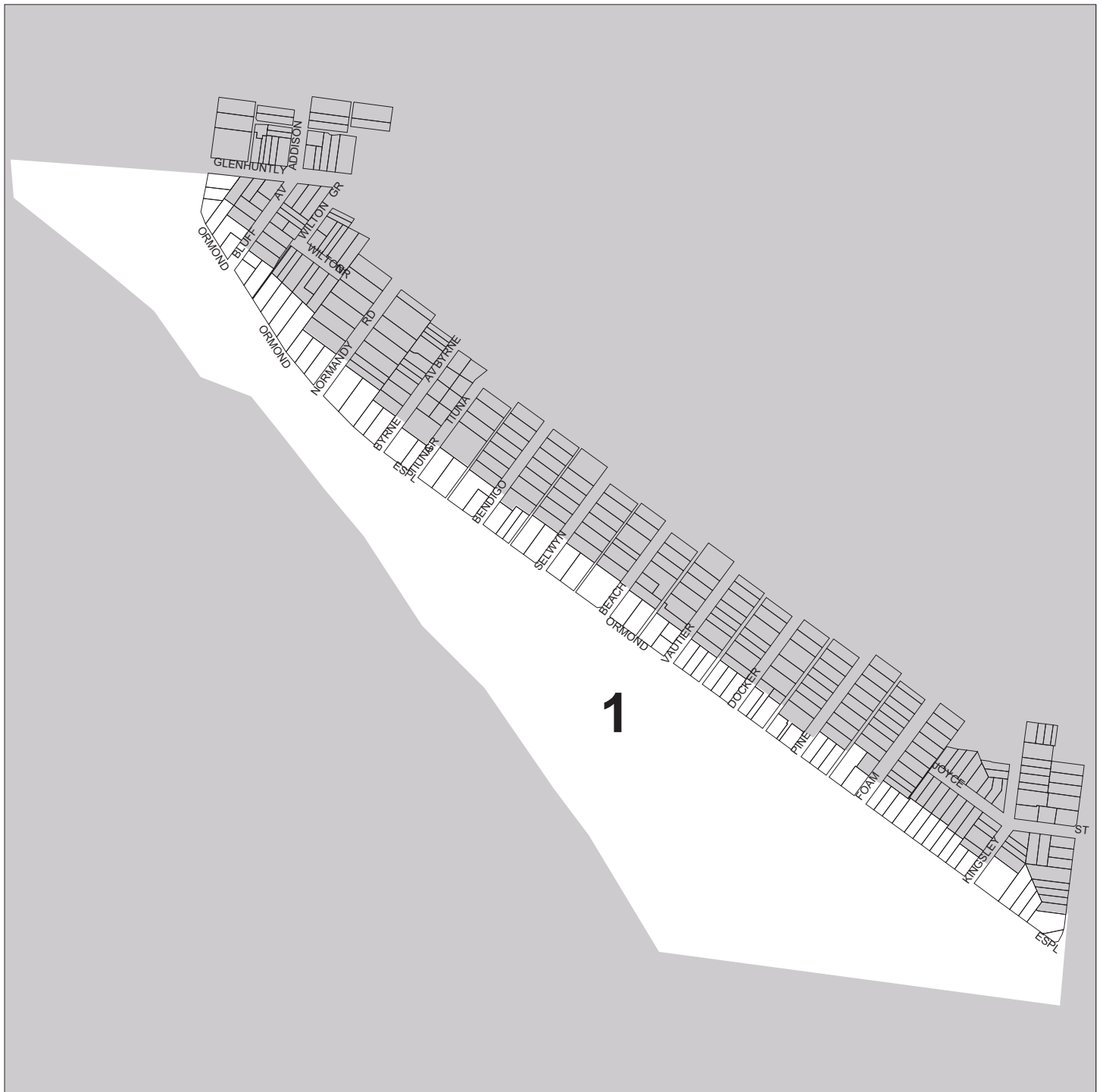

Boundary streets:

Foreshore, St Kilda St, Ormond Esplanade, Glenhuntly Rd.

Streets in the area:

Head St, Ormond Esp, Point Ormond Rd,

Description of the character of the area:

The area has been developed with dwellings and apartments fronting Ormond Esplanade opposite Point Ormond Reserve and Elwood Park.

Lot sizes are predominantly greater than 750 square metres and buildings constructed in a range of styles are generally large.

Buildings remain largely intact although renovations, fencing, maintenance and occasional replacements reduce its coherence.

The foreshore open space, views and heavy traffic are major determinants of the character of this area distinguishing it from the adjoining residential area to the north.

<i>Element</i>	<i>Description</i>
Dominant style	1920s - 1940s
Dominant scale	one and two storey
Dominant material	stucco and render/minor variation
Dominant roof	no dominance/terracotta
Setback	5-9 metres/minor variation
Heritage	more than 50% of sites identified as heritage places
Gardens	visible/hidden/small
Fences	medium height/various materials

The existing urban character of the City of Port Phillip has been assessed using 24 character elements. The design should especially respond to the important and very important elements, which in this area are:

<i>Element</i>	<i>Importance</i>
Views	Very important
Traffic	Very important
Building style	Very important
Foreshore	Very important
Lot size	Important
Street dimensions	Important
Setbacks	Important
Building scale	Important
Heritage	Important
Open space	Important

A comprehensive urban character assessment and policy statement for the area is available from the Council .



City of Port Phillip
URBAN CHARACTER DESCRIPTION

AREA 2: LAND GENERALLY BOUNDED BY ORMOND ROAD, GLENHUNTLY ROAD AND ORMOND ESPLANADE, ELWOOD

The following description should be used in carrying out the site analysis and design response to your site. Pay attention to the very important and important character elements listed here, as well as the actual conditions observed at the site analysis stage.

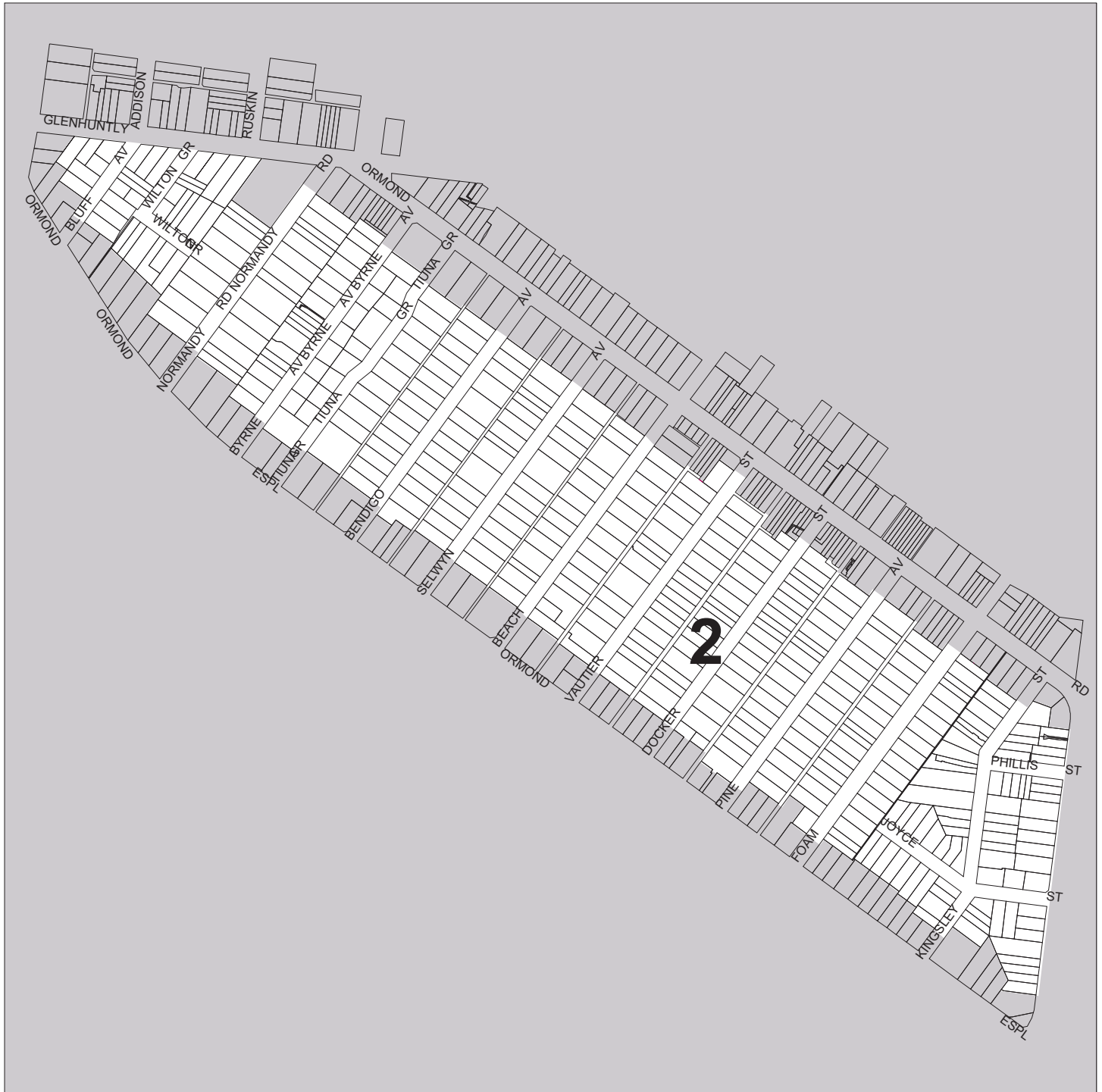

Boundary streets:

Ormond Esplanade, Glenhuntly Road, St Kilda St, Ormond Rd.

Streets in the area:

Beach Av, Bendigo Av, Bluff Av, Byrne Av, Docker St, Foam St, Joyce St, Kingsley St, Normandy Rd, Phyllis St, Pine Av, Selwyn Av, Tiuna Gv, Vautier St, Wilton Gv,

Description of the character of the area:

This area is located on a low ridge providing views to open space and Port Phillip Bay from the southern ends of most streets. The predominant lot size is greater than 750 square metres and the street pattern is fairly consistent with rear lanes constructed in bluestone.

The area retains a limited number of large Victorian houses but has been largely developed during the inter-war period with detached dwellings and walk-up apartment buildings. The area also has a limited number of more recent flats and houses.

The large lots occupied by single dwellings often have generous gardens however, privacy is reduced by the high proportion of two and three storey houses and flats.

Most streets are lined with Plane trees and this aspect together with the relatively rich and varied architectural style and scale are important factors contributing to the character of the area.

The area has excellent access to open space, the foreshore and local shops and limited through traffic.

<i>Element</i>	<i>Description</i>
Dominant style	1920s - 1940s
Dominant scale	one and two storey
Dominant material	stucco and render/minor variation
Dominant roof	pitched/terracotta
Setback	less than 5 metres/minor variation
Heritage	less than 50% of sites identified as heritage places
Gardens	visible/hidden/medium/small
Fences	medium height/various materials

The existing urban character of the City of Port Phillip has been assessed using 24 character elements. The design should especially respond to the important and very important elements, which in this area are:

<i>Element</i>	<i>Importance</i>
Pattern	Very important
Building style	Very important
Open space	Very important
Lot size	Important
Street trees	Important
Street detailing	Important
Setbacks	Important
Building scale	Important
Heritage	Important
Foreshore	Important

A comprehensive urban character assessment and policy statement for the area is available from the Council .



City of Port Phillip
URBAN CHARACTER DESCRIPTION

AREA 3: ORMOND ROAD BETWEEN BEACH AVENUE AND PINE AVENUE, ELWOOD

The following description should be used in carrying out the site analysis and design response to your site. Pay attention to the very important and important character elements listed here, as well as the actual conditions observed at the site analysis stage.

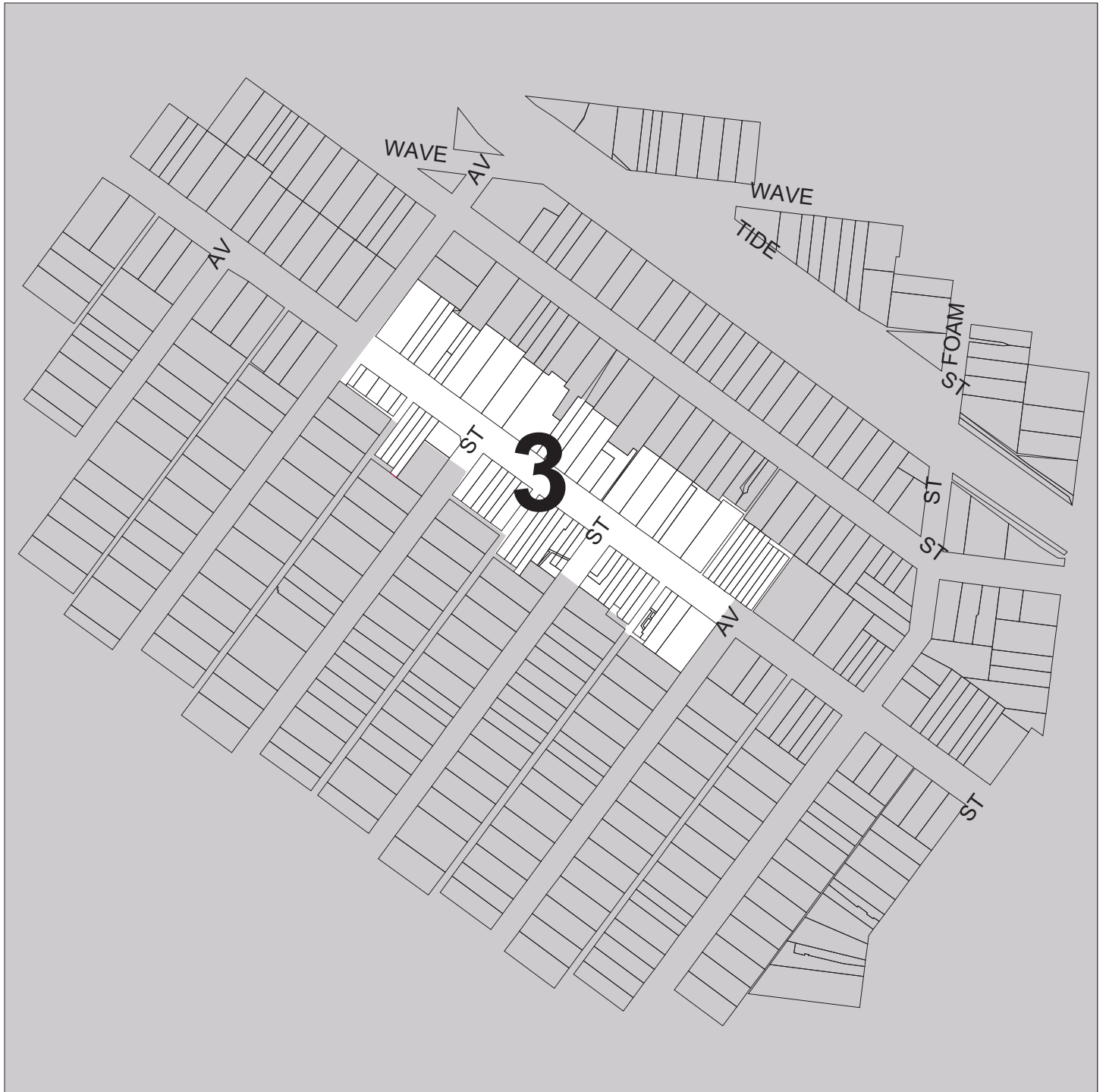

Boundary streets:

Beach Ave, Pine Ave, Ormond Rd.

Streets in the area:

Ormond Rd,

Description of the character of the area:

This area is distinct from its surroundings because it is a commercial shopping centre serving adjacent residential areas.

Largely developed during the inter-war period, it still retains most of the original buildings. These include a mix of single and double storey terraced shops with a few free standing buildings on larger lots.

The design of the street has been modified with traffic control devices, landscaping, brick feature paving and walls.

<i>Element</i>	<i>Description</i>
Dominant style	1920s - 1940s
Dominant scale	one and two storey
Dominant material	stucco and render/minor variation
Dominant roof	concealed by parapets/metal
Setback	no setback/minor variation
Heritage	shops on north side of street identified as heritage places
Gardens	invisible
Fences	none

The existing urban character of the City of Port Phillip has been assessed using 24 character elements. The design should especially respond to the important and very important elements, which in this area are:

<i>Element</i>	<i>Importance</i>
Setbacks	Very important
Land use	Very important
Parking	Important
Footpaths	Important
Street detailing	Important
Signage	Important
Building style	Important
Building scale	Important
Access	Important

A comprehensive urban character assessment and policy statement for the area is available from the Council .



City of Port Phillip
URBAN CHARACTER DESCRIPTION

AREA 4: LAND GENERALLY BOUNDED BY GLENHUNTLY ROAD, ST KILDA STREET AND ORMOND ROAD, ELWOOD

The following description should be used in carrying out the site analysis and design response to your site. Pay attention to the very important and important character elements listed here, as well as the actual conditions observed at the site analysis stage.



Boundary streets:

Glenhuntly Rd, St Kilda St, Ormond Rd.

Streets in the area:

Beach Av, Foam St, Kingsley St, Ormond Rd, Spray St, Wave St,

Description of the character of the area:

The area has been subdivided into lots with a predominant size of 650 - 750 square metres around the Elwood Canal drainage reservation which provides a focus for the area.

Developed for residential purposes, buildings consist largely of detached dwellings and walk-up flats from the inter-war period. The flats tend to be concentrated on the perimeter main roads.

Streets are lined with deciduous trees and much of the original detailing is still intact.

The area has excellent access to shops, services and transport.

<i>Element</i>	<i>Description</i>
Dominant style	1920s -1940s
Dominant scale	one, two and three storey
Dominant material	brick or masonry
Dominant roof	pitched/terracotta
Setback	less than 5 metres/mixed
Heritage	some heritage qualities/no protection
Gardens	visible/medium
Fences	low height/various materials

The existing urban character of the City of Port Phillip has been assessed using 24 character elements. The design should especially respond to the important and very important elements, which in this area are:

<i>Element</i>	<i>Importance</i>
Building style	Very important
Street trees	Important
Fences	Important
Building scale	Important
Housing type	Important
Land use	Important
Access	Important
Open space	Important

A comprehensive urban character assessment and policy statement for the area is available from the Council .



City of Port Phillip
URBAN CHARACTER DESCRIPTION

AREA 5: INTERSECTION OF GLENHUNTLY ROAD AND ORMOND ROAD, ELWOOD

The following description should be used in carrying out the site analysis and design response to your site. Pay attention to the very important and important character elements listed here, as well as the actual conditions observed at the site analysis stage.

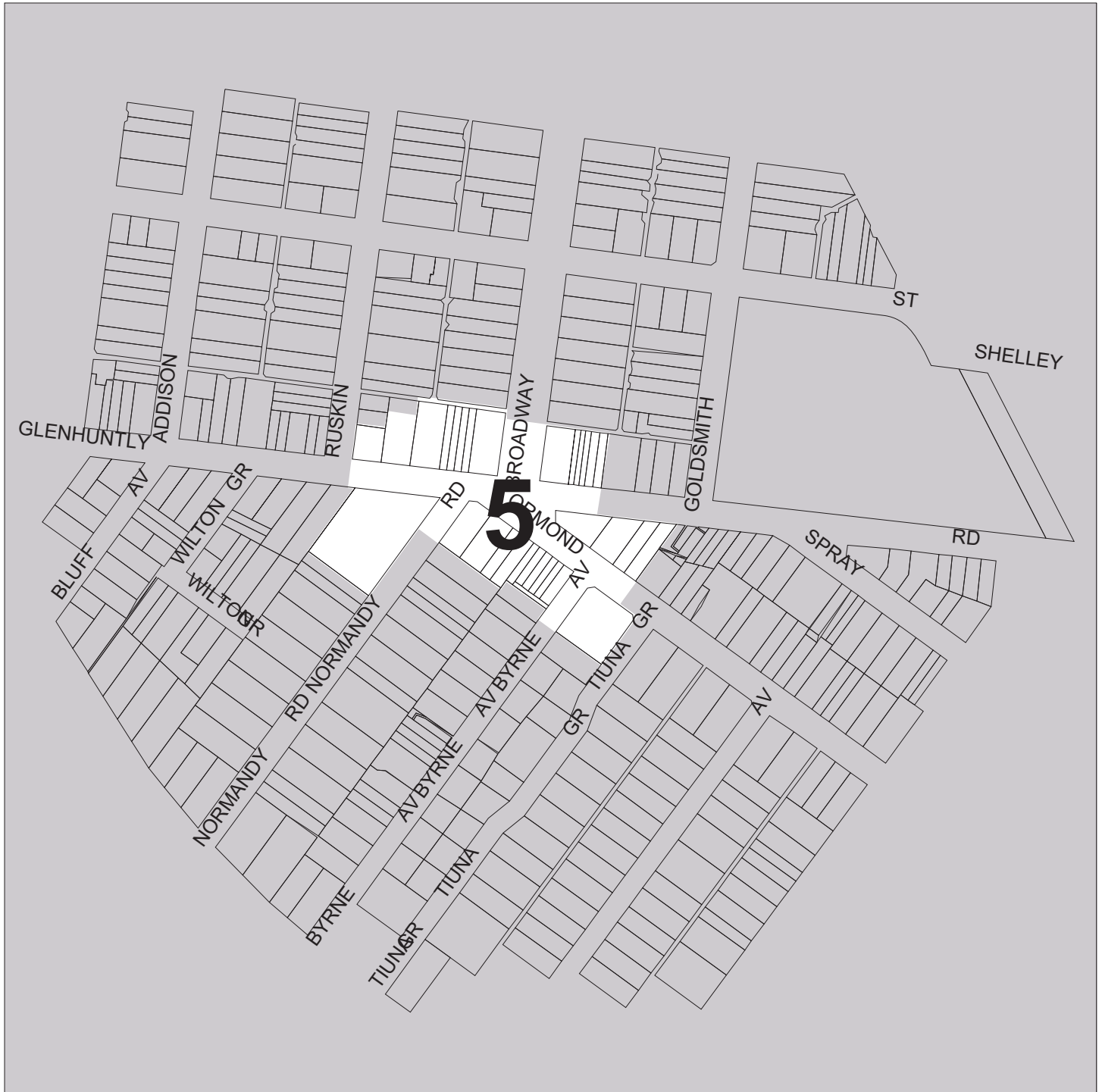

Boundary streets:

Ruskin St, Tiuna Gve,
Glenhuntly - Ormond Rd junction.

Streets in the area:

Glenhuntly Rd, Ormond Rd,

Description of the character of the area:

This small commercial area has been developed with buildings dating back to the 1900's. These buildings contribute to the character of the area due to their scale, styles and prominent location. Shop top housing also contributes to the viability and life of this area.

Whilst the large roundabout with mature gums contributes to the character of the area, street detailing and other landscaping is inconsistent with the heritage qualities of the area.

<i>Element</i>	<i>Description</i>
Dominant style	no dominance
Dominant scale	two storey
Dominant material	stucco and render/minor variation
Dominant roof	concealed by parapets/terracotta
Setback	no setback/minor variation
Heritage	identified heritage place
Gardens	very few/visible/medium/small
Fences	none

The existing urban character of the City of Port Phillip has been assessed using 24 character elements. The design should especially respond to the important and very important elements, which in this area are:

<i>Element</i>	<i>Importance</i>
Building style	Very important
Heritage	Very important
Pattern	Important
Street dimensions	Important
Traffic	Important
Street trees	Important
Parking	Important
Footpaths	Important
Street detailing	Important
Setbacks	Important
Building scale	Important
Land use	Important

A comprehensive urban character assessment and policy statement for the area is available from the Council .



City of Port Phillip
URBAN CHARACTER DESCRIPTION

AREA 6: LAND GENERALLY BOUNDED BY BARKLY STREET, MITFORD STREET, BROADWAY AND GLENHUNTLY ROAD, ELWOOD

The following description should be used in carrying out the site analysis and design response to your site. Pay attention to the very important and important character elements listed here, as well as the actual conditions observed at the site analysis stage.

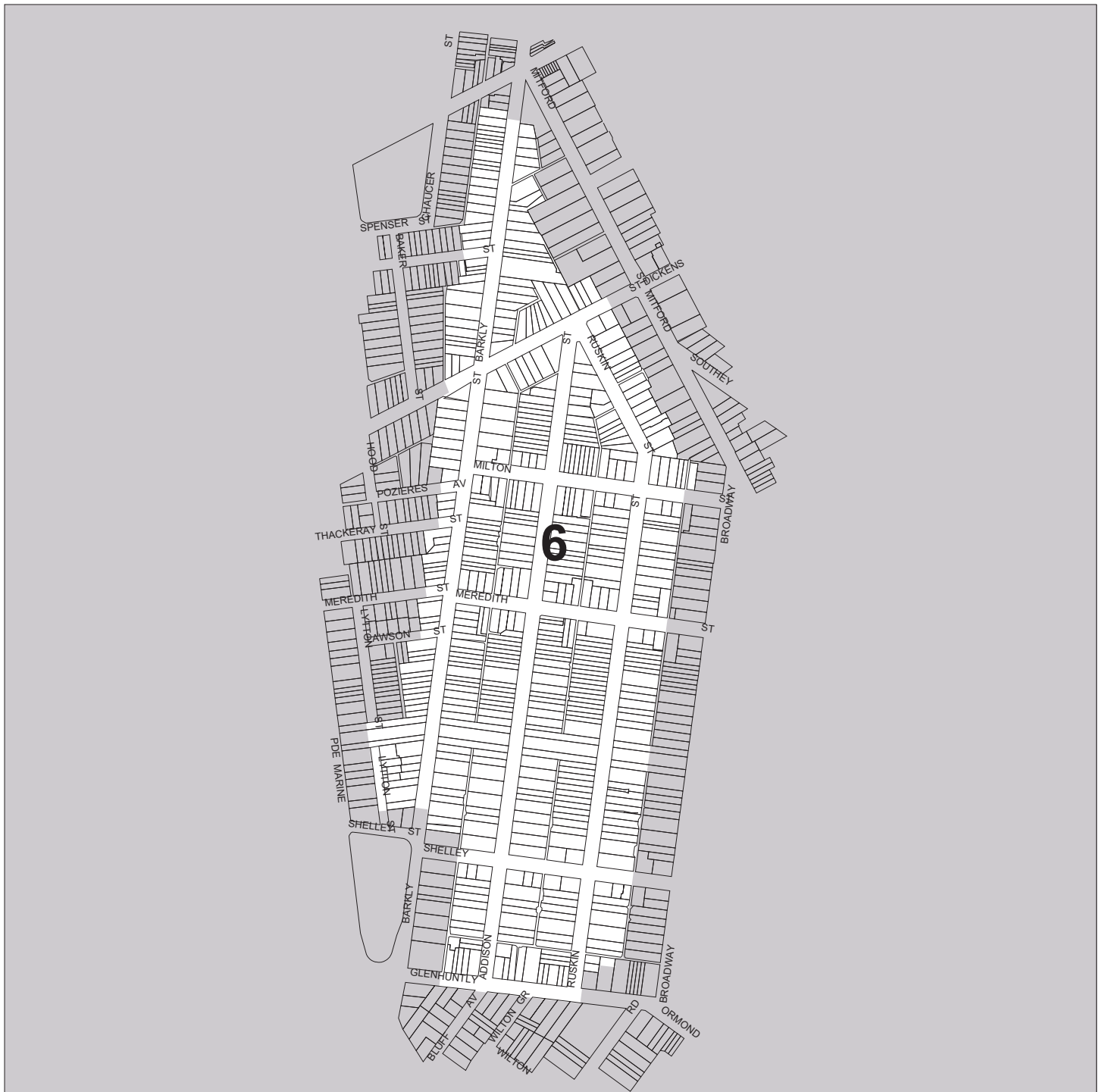

Barkly, Ruskin, Glenhuntly Rds.

Streets in the area:

Addison St, Barkly St, Dickens St, Glenhuntly Rd, Meredith St, Milton St, Ruskin St, Shelley St, Rosetti La,

Description of the character of the area:

The area has a consistent pattern of wide streets flanked by plane trees providing access to reasonably deep lots, mostly between 300-650 square metres.

It has been developed for residential purposes during Edwardian and inter-war periods with a mixture of duplex housing and flat complexes. There has been some further development of flats during the post-war period with little replacement of single dwellings.

Elwood Canal passes through the southern part of the area creating a distinct character for the immediate environment. The character is influenced by the broad expanse of water, a cycle path and associated landscaping.

With the exception of Barkly Street, most streets are free of through traffic. The area is close to neighbourhood shopping centres, community facilities and open space.

<i>Element</i>	<i>Description</i>
Dominant style	1920s - 1940s
Dominant scale	one and two storey
Dominant material	brick or masonry/mixed
Dominant roof	pitched/terracotta
Setback	less than 5 metres/minor variation
Heritage	identified heritage places adjacent to southern boundary
Gardens	visible/medium/small
Fences	low height/various materials

The existing urban character of the City of Port Phillip has been assessed using 24 character elements. The design should especially respond to the important and very important elements, which in this area are:

<i>Element</i>	<i>Importance</i>
Street trees	Very important
Building style	Very important
Views	Important
Pattern	Important
Street dimensions	Important
Street detailing	Important
Fences	Important
Front gardens	Important
Housing type	Important
Land use	Important

A comprehensive urban character assessment and policy statement for the area is available from the Council .



City of Port Phillip
URBAN CHARACTER DESCRIPTION

AREA 7: BROADWAY

The following description should be used in carrying out the site analysis and design response to your site. Pay attention to the very important and important character elements listed here, as well as the actual conditions observed at the site analysis stage.

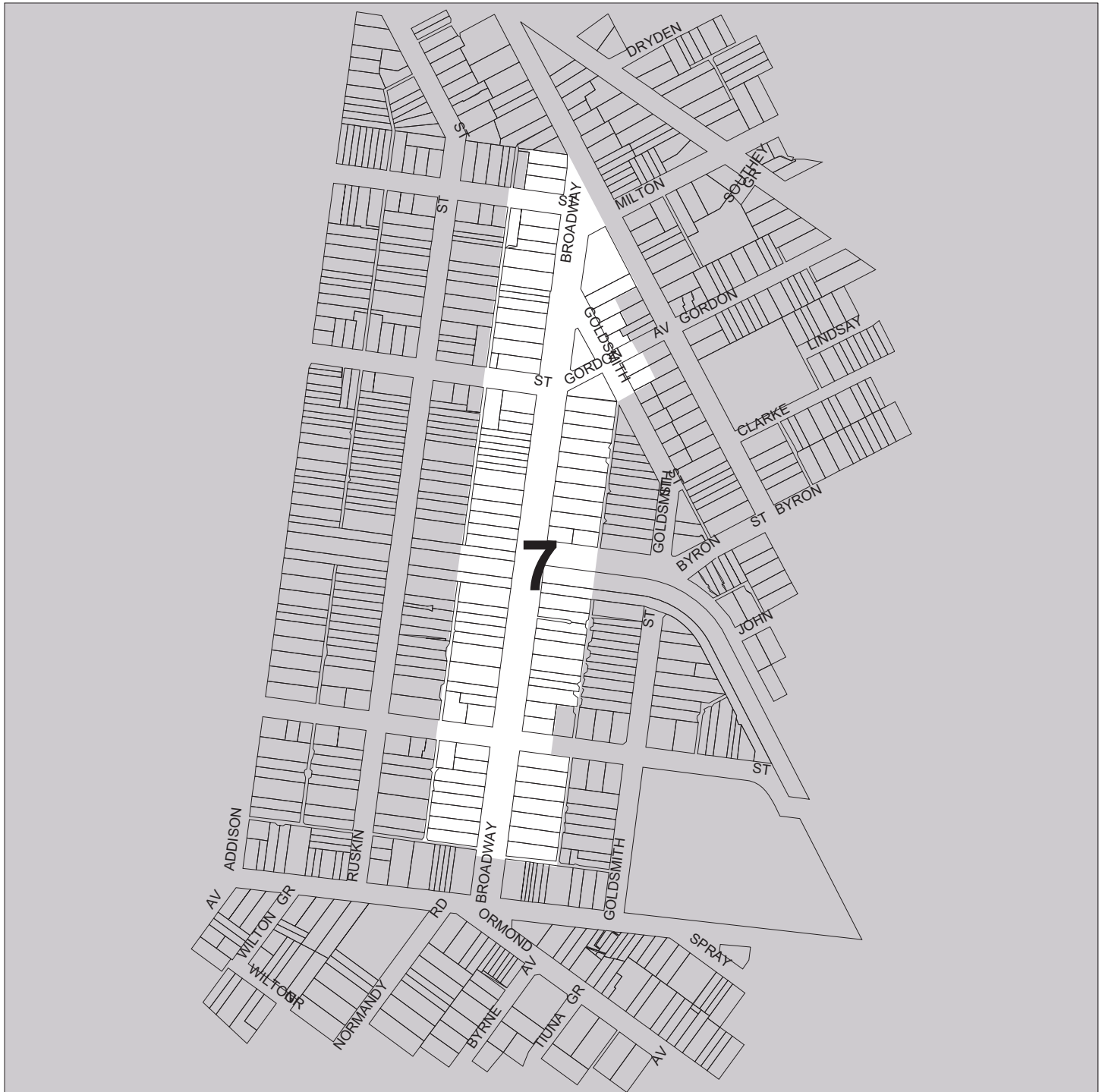

Broadway.

Streets in the area:

Broadway, Byron St, Goldsmith St, Gordon Av,

Description of the character of the area:

This area is distinguished from adjoining areas by the exceptionally wide road reservation and the slightly larger lot sizes.

Development consists of Edwardian and inter-war houses and apartment buildings together with a number of post-war flat blocks. At the northern end of the area, original period apartment buildings dominate the street corners providing views over the small triangular parks.

Broadway is a local collector street that carries reasonable volumes of through traffic during peak periods. The street retains original edge detailing however the centre has been modified to incorporate roundabouts and planter tree islands.

The area is more distant from local shopping, community and transport facilities.

<i>Element</i>	<i>Description</i>
Dominant style	1920s - 1940s
Dominant scale	one and two storey
Dominant material	stucco and render/minor variation
Dominant roof	pitched/terracotta
Setback	less than 5 metres/minor variation
Heritage	identified heritage places adjacent to northern boundary
Gardens	visible/small
Fences	low/various materials

The existing urban character of the City of Port Phillip has been assessed using 24 character elements. The design should especially respond to the important and very important elements, which in this area are:

<i>Element</i>	<i>Importance</i>
Street dimensions	Very important
Street trees	Very important
Building style	Very important
Views	Important
Lot size	Important
Street detailing	Important
Front gardens	Important
Building scale	Important
Housing type	Important
Heritage	Important
Land use	Important

A comprehensive urban character assessment and policy statement for the area is available from the Council .



City of Port Phillip
URBAN CHARACTER DESCRIPTION

AREA 8: LAND GENERALLY BOUNDED BY MITFORD STREET, BROADWAY AND GLENHUNTLY ROAD, ELWOOD

The following description should be used in carrying out the site analysis and design response to your site. Pay attention to the very important and important character elements listed here, as well as the actual conditions observed at the site analysis stage.

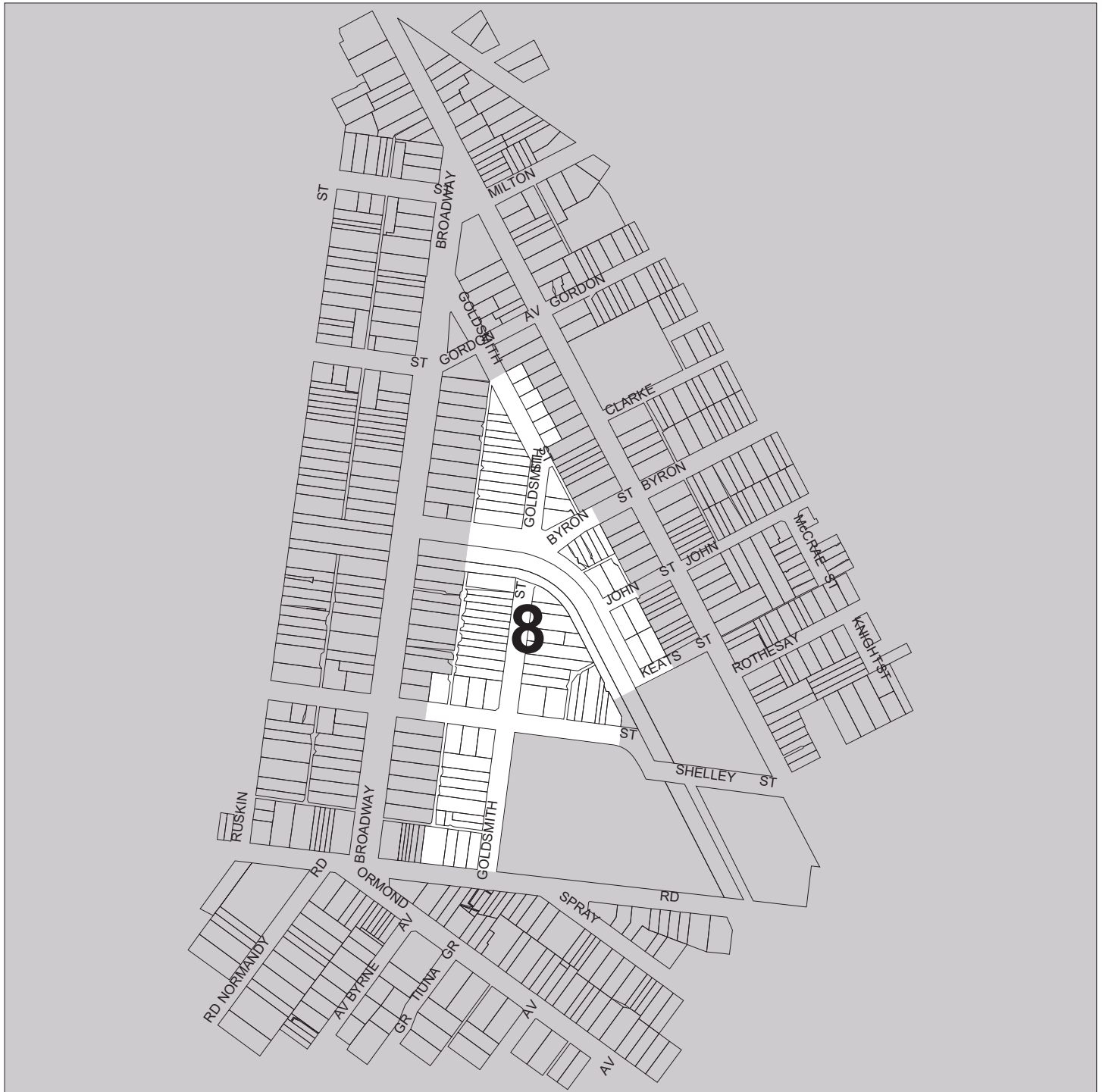

Boundary streets:

Mitford, Broadway, Glenhuntly Rds.

Streets in the area:

Goldsmith St, Shelley St,

Description of the character of the area:

The area has a pattern of streets with consistent detailing and mature Plane trees that form a full canopy over the road spaces throughout the area. The subdivision layout is influenced by the presence of the Elwood Canal and lot sizes are predominantly 300 - 650 square metres.

The area was developed in the inter-war period with detached houses and flats of various styles. It remains largely intact with the exception of one mock Edwardian replacement dwelling and minor renovation changes. Fences are also notable for their consistency.

The area is free from through traffic and close to schools and open space.

<i>Element</i>	<i>Description</i>
Dominant style	1920s - 1940s
Dominant scale	one storey
Dominant material	stucco and render/consistent
Dominant roof	pitched/terracotta
Setback	5 - 9 metres/minor variation
Heritage	identified heritage places adjacent to southern boundary
Gardens	visible/medium
Fences	low height/masonry/consistent

The existing urban character of the City of Port Phillip has been assessed using 24 character elements. The design should especially respond to the important and very important elements, which in this area are:

<i>Element</i>	<i>Importance</i>
Street trees	Very important
Fences	Very important
Building style	Very important
Heritage	Very important
Street detailing	Important
Setbacks	Important
Front gardens	Important
Building scale	Important
Housing type	Important
Land use	Important

A comprehensive urban character assessment and policy statement for the area is available from the Council .



City of Port Phillip
URBAN CHARACTER DESCRIPTION

AREA 9: LAND GENERALLY BOUNDED BY GLENHUNTLY ROAD, MITFORD STREET, GOLDSMITH STREET, BRIGHTON ROAD, GORDON STREET AND MASON STREET, ELWOOD

The following description should be used in carrying out the site analysis and design response to your site. Pay attention to the very important and important character elements listed here, as well as the actual conditions observed at the site analysis stage.

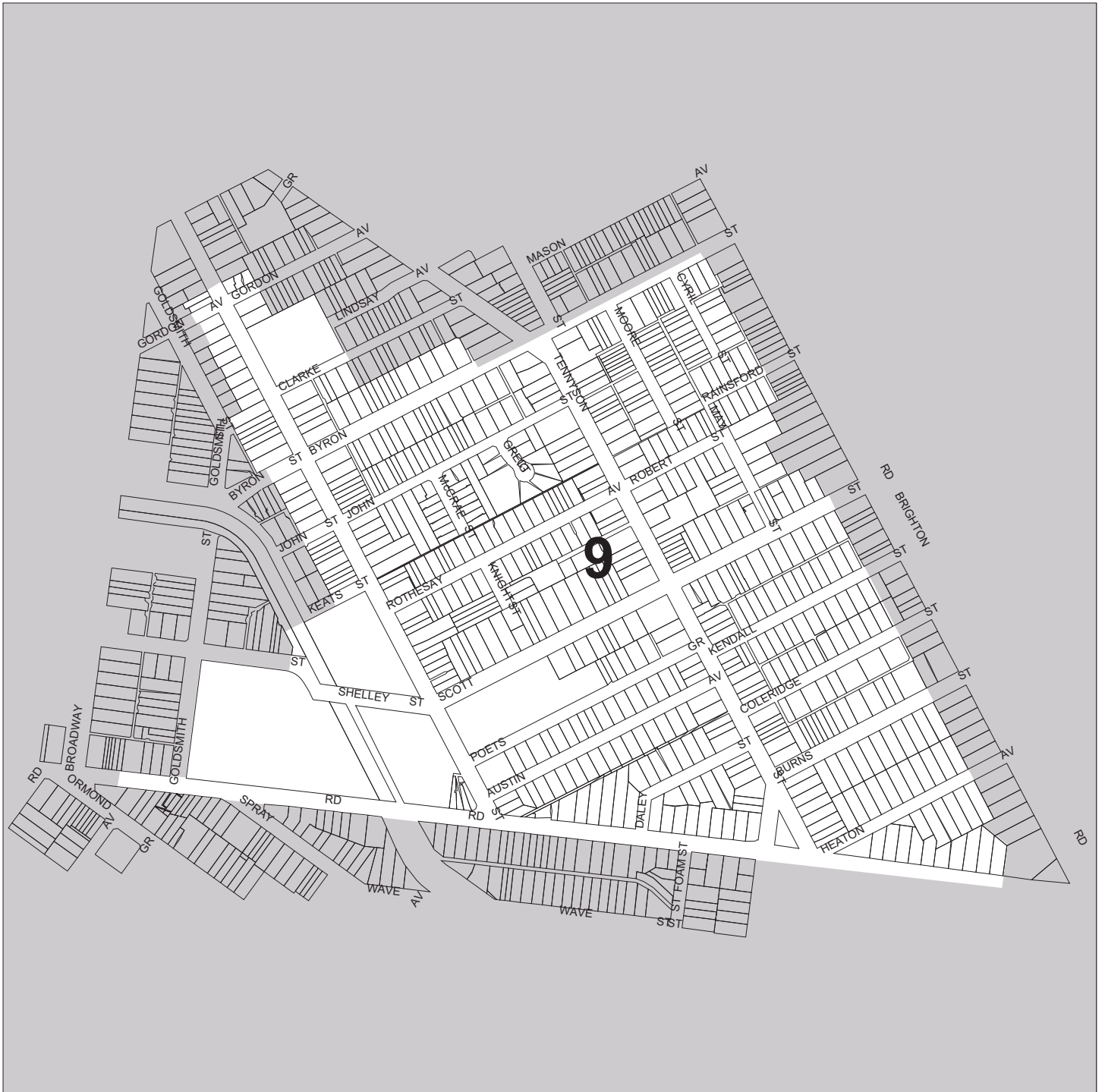

Boundary streets:

Glenhuntly Rd, Mitford St, Goldsmith St, Brighton Rd, Gordon St, Mason St.

Streets in the area:

Austin Av, Burns St, Byron St, Coleridge St, Cyril St, Daley St, Glenhuntly Rd, Goldsmith St, Greig St, Heaton Av, John St, Keats St, Kendall St, Knight St, May St, McCrae St, Mitford St, Moore St, Poets Gv, Rainsford St, Robert St, Rothesay Av, Scott St, Shelley St, Tennyson St North, Tennyson St North, Florence La,

Description of the character of the area:

The area includes low lying areas near Elwood Canal and land sloping upwards toward Brighton Road. Within a distorted grid pattern, the predominant lot size is 300 - 650 square metres and frontages vary in width.

The area was largely developed during the inter-war period however the eastern half has been substantially redeveloped with flat blocks during the 1960's and 1970's.

Tennyson, Mitford and Byron Streets are wide streets, but the area also includes a network of smaller streets, lanes and cul-de-sacs, which add diversity to the area.

The small shopping area in Tennyson Street is a viable local shopping centre and community focus. The grouping of schools and open space along Elwood Canal is another important focus for this area.

<i>Element</i>	<i>Description</i>
Dominant style	1920s -1940s
Dominant scale	one and two storey
Dominant material	stucco and render/mixed
Dominant roof	pitched/terracotta
Setback	less than 5 metres/mixed
Heritage	identified heritage places restricted to south-east corner
Gardens	visible/medium/small
Fences	low/various materials

The existing urban character of the City of Port Phillip has been assessed using 24 character elements. The design should especially respond to the important and very important elements, which in this area are:

<i>Element</i>	<i>Importance</i>
Building style	Very important
Building scale	Very important
Pattern	Important
Setbacks	Important
Housing type	Important
Land use	Important
Access	Important

A comprehensive urban character assessment and policy statement for the area is available from the Council .



City of Port Phillip
URBAN CHARACTER DESCRIPTION

AREA 10: SOUTHEY STREET, ELWOOD

The following description should be used in carrying out the site analysis and design response to your site. Pay attention to the very important and important character elements listed here, as well as the actual conditions observed at the site analysis stage.

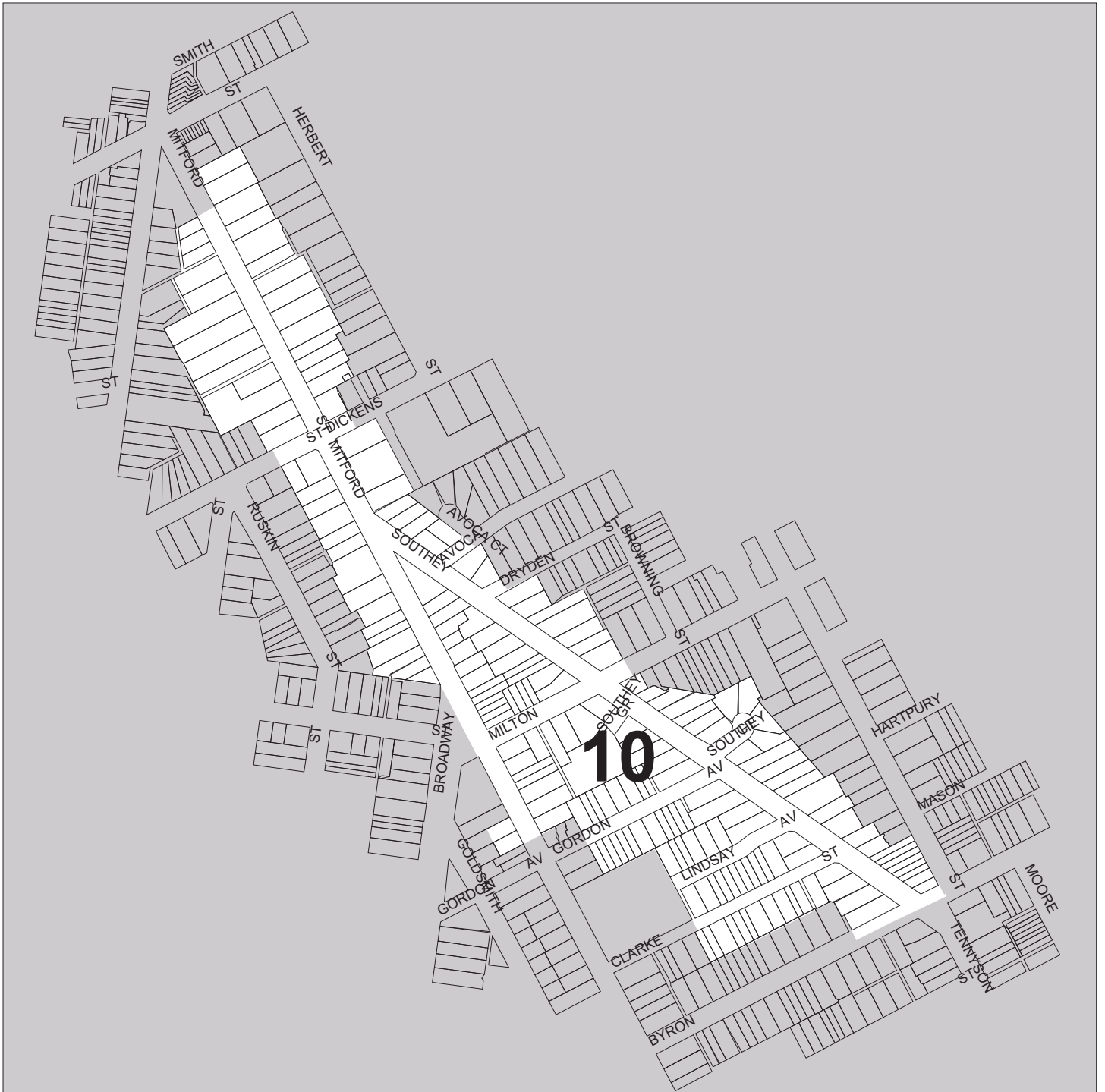

Boundary streets:

Southey St, Mitford St, Byron St.

Streets in the area:

Avoca Ct, Bayview St, Clarke St, Gordon Av, Lindsay Av, Milton St, Mitford St, Southey Ct, Southey Gv, Southey St,

Description of the character of the area:

A diversity of housing scale and type as well as the relatively high density is a strong attribute of this area.

Walk-up apartment blocks dating from the inter-war period display outstanding design quality, and these together with apartment buildings from the post- Second World War period, tend to create a sense of enclosure even in the wide streets due to the relatively small setback and large building scale.

Cross streets in the area tend to have smaller scale housing on smaller lots, and more intimately proportioned streets.

Substantial changes have been made to the design of Southey Street with the introduction of road narrowings and sections of angled parking. Street trees are mostly deciduous but quite mixed within some streets.

<i>Element</i>	<i>Description</i>
Dominant style	1920s -1940s
Dominant scale	one, two and three storey
Dominant material	stucco and render/mixed
Dominant roof	pitched/terracotta
Setback	less than 5 metres
Heritage	@50% identified heritage places
Gardens	visible/small
Fences	low height/various materials

The existing urban character of the City of Port Phillip has been assessed using 24 character elements. The design should especially respond to the important and very important elements, which in this area are:

<i>Element</i>	<i>Importance</i>
Building style	Very important
Building scale	Very important
Housing type	Very important
Land use	Very important
Landform	Important
Street trees	Important
Parking	Important
Street detailing	Important
Fences	Important
Setbacks	Important
Heritage	Important

A comprehensive urban character assessment and policy statement for the area is available from the Council .



City of Port Phillip
URBAN CHARACTER DESCRIPTION

AREA 11: LAND GENERALLY BOUNDED BY CARLISLE STREET, BRIGHTON ROAD, MITFORD STREET AND SOUTHEY STREET, ST KILDA

The following description should be used in carrying out the site analysis and design response to your site. Pay attention to the very important and important character elements listed here, as well as the actual conditions observed at the site analysis stage.

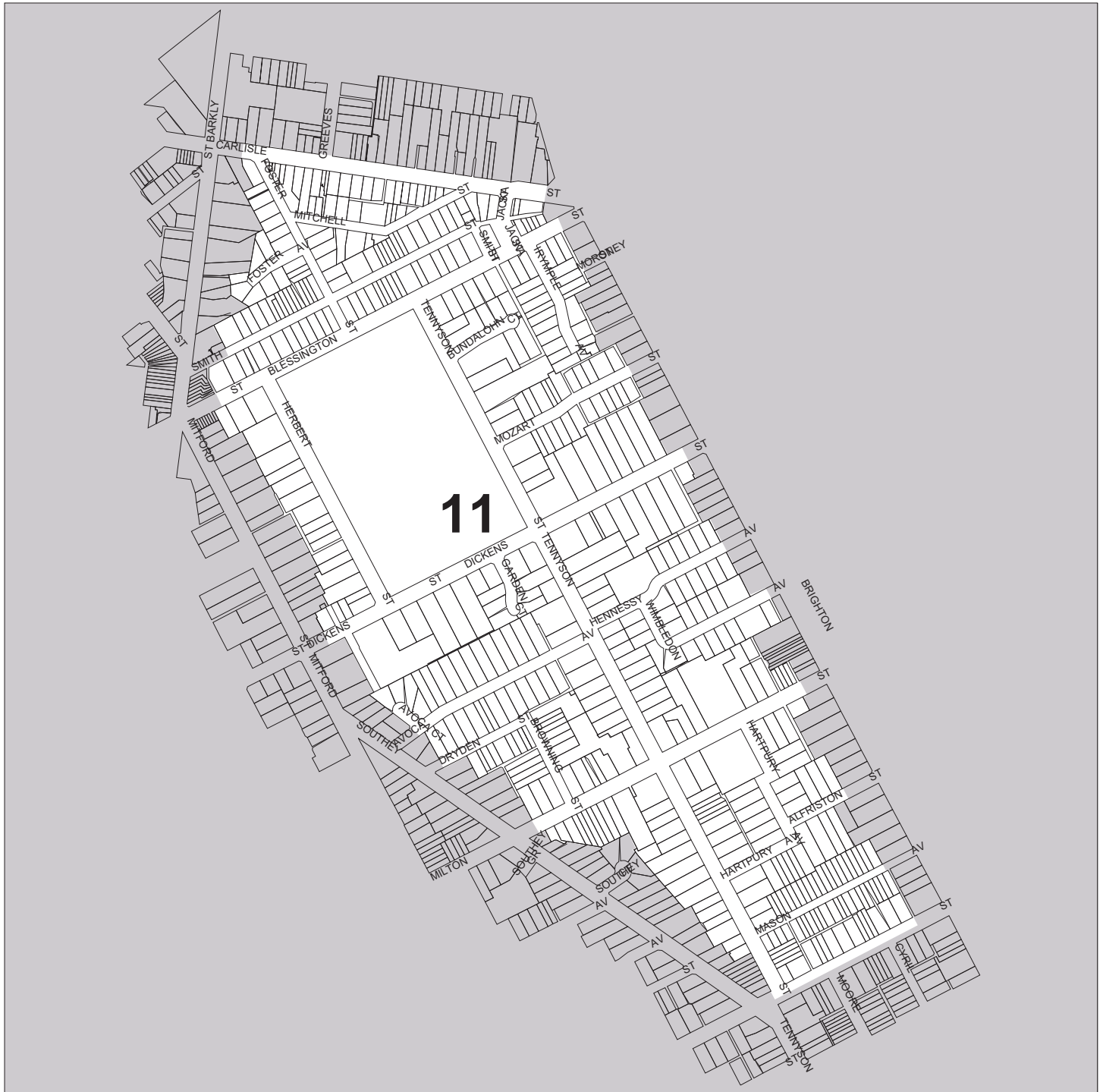

Boundary streets:

Brighton Rd, Carlisle St, Barkly St, Southey St, Milson Ave.

Streets in the area:

Alfriston St, Avoca Av, Blessington St, Browning St, Bundalohn Ct, Byron St, Carlisle St, Dickens St, Dryden St, Foster Av, Garden Ct, Hartpury Av, Hennessy Av, Herbert St, Irymple Av, Jacka St, Mason Av, Milton St, Mitchell St, Mozart St, Smith St, Tennyson St North, Tennyson St North, Wimbledon Av,

Description of the character of the area:

The area was subdivided into large allotments and developed with a number of large houses during the 1850's. Further subdivision to create house allotments and apartment buildings occurred during Edwardian and inter-war periods with the most recent redevelopment during the 1960's and 1970's replacing many houses with two and three storey flat blocks.

The succession of development phases has created a rich mixture of housing type, style and scale which is an important element of its present character. However, the post-Second World War flat buildings are less sympathetic.

In addition, the St Kilda Botanic Gardens is a central focus and activity centre that adds greatly to the character of the area.

The streets are quite varied in their proportions and landscape treatment although deciduous trees predominate.

<i>Element</i>	<i>Description</i>
Dominant style	1920s - 1940s
Dominant scale	one and two storey
Dominant material	stucco and render
Dominant roof	pitched/terracotta
Setback	less than 5 metres/minor variation
Heritage	significant area identified as heritage places
Gardens	visible/medium/small
Fences	low height/various materials

The existing urban character of the City of Port Phillip has been assessed using 24 character elements. The design should especially respond to the important and very important elements, which in this area are:

<i>Element</i>	<i>Importance</i>
Building style	Very important
Building scale	Very important
Heritage	Very important
Open space	Very important
Lot size	Important
Street dimensions	Important
Street trees	Important
Parking	Important
Street detailing	Important
Fences	Important
Setbacks	Important
Housing type	Important
Access	Important

A comprehensive urban character assessment and policy statement for the area is available from the Council .



City of Port Phillip
URBAN CHARACTER DESCRIPTION
AREA 12: BRIGHTON ROAD, ST KILDA

The following description should be used in carrying out the site analysis and design response to your site. Pay attention to the very important and important character elements listed here, as well as the actual conditions observed at the site analysis stage.

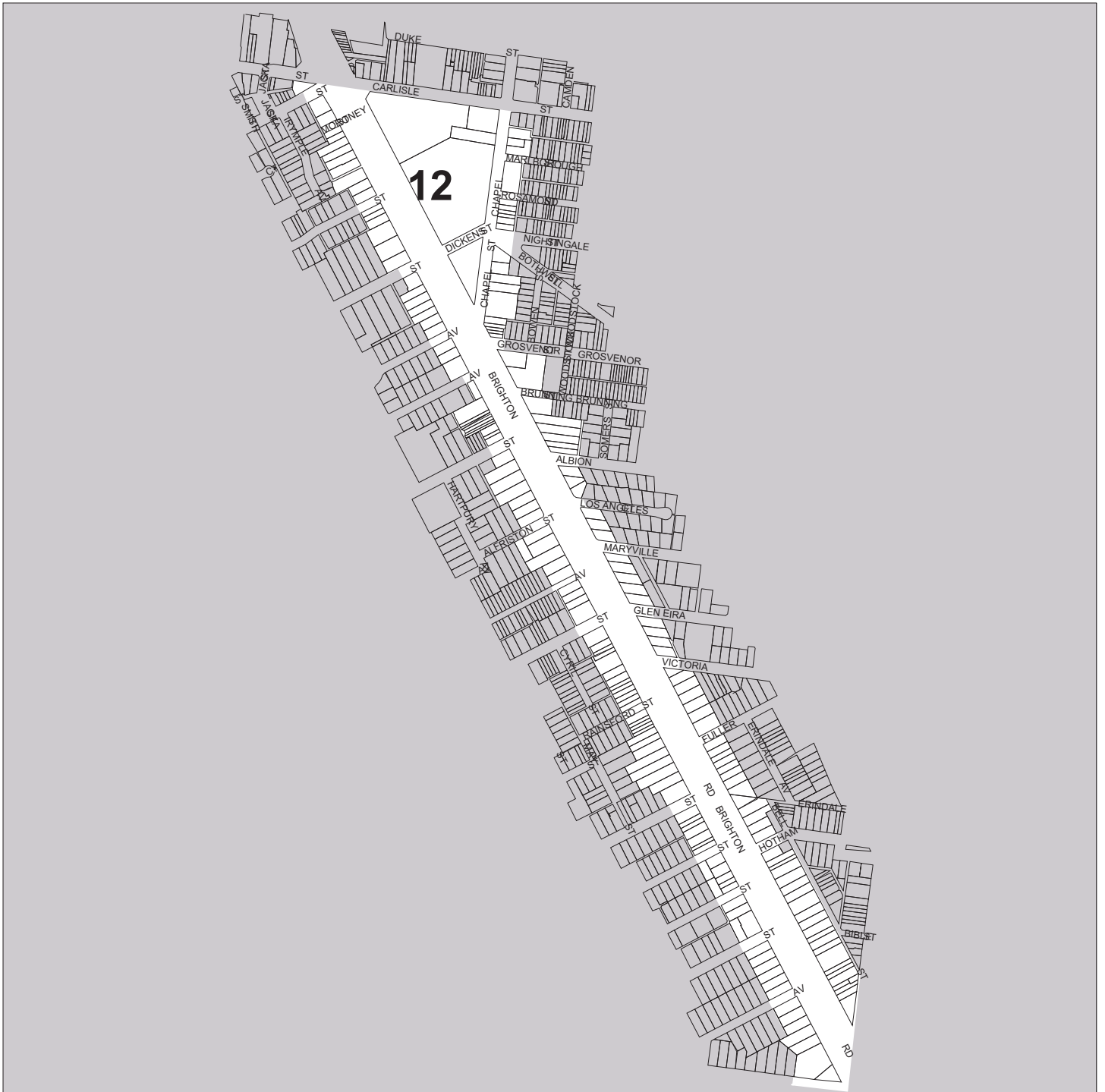

Boundary streets:

Carlisle St, Glenhuntly Rd, Chapel St, Brighton Rd.

Streets in the area:

Bell St, Brighton Rd, Chapel St, Dickens St, Moroney St,

Description of the character of the area:

The qualities that distinguish the area from the adjoining areas are the road, scale, landscape treatment and trees.

Development along Brighton Road is mixed in scale and style from Victorian and inter-war houses and flats, through to post-war flat blocks, which dominate much of the western edge of the road.

The area also has a limited number of commercial sites with a strong visual presence. Some of these, particularly the car yards in Chapel Street detract from the quality of the area.

The town hall triangle is a significant collection of public buildings and associated landscaping with identified heritage value and Brighton Road is one of Melbourne's more attractive boulevards with a unique plantation of flowering gums.

The area has excellent access to shops, services and public transport including the Brighton Road tram route.

<i>Element</i>	<i>Description</i>
Dominant style	1920s - 1940s
Dominant scale	one and two storey
Dominant material	stucco and render/mixed
Dominant roof	pitched/terracotta
Setback	less than 5 metres/varied
Heritage	entire area identified as heritage place
Gardens	visible/hidden/medium/small
Fences	medium height/varied materials

The existing urban character of the City of Port Phillip has been assessed using 24 character elements. The design should especially respond to the important and very important elements, which in this area are:

<i>Element</i>	<i>Importance</i>
Street dimensions	Very important
Traffic	Very important
Street trees	Very important
Access	Very important
Views	Important
Heritage	Important

A comprehensive urban character assessment and policy statement for the area is available from the Council .



City of Port Phillip
URBAN CHARACTER DESCRIPTION

AREA 13: CHAPEL STREET, CARLISLE STREET, BRUNNING STREET, RAILWAY LINE

The following description should be used in carrying out the site analysis and design response to your site. Pay attention to the very important and important character elements listed here, as well as the actual conditions observed at the site analysis stage.

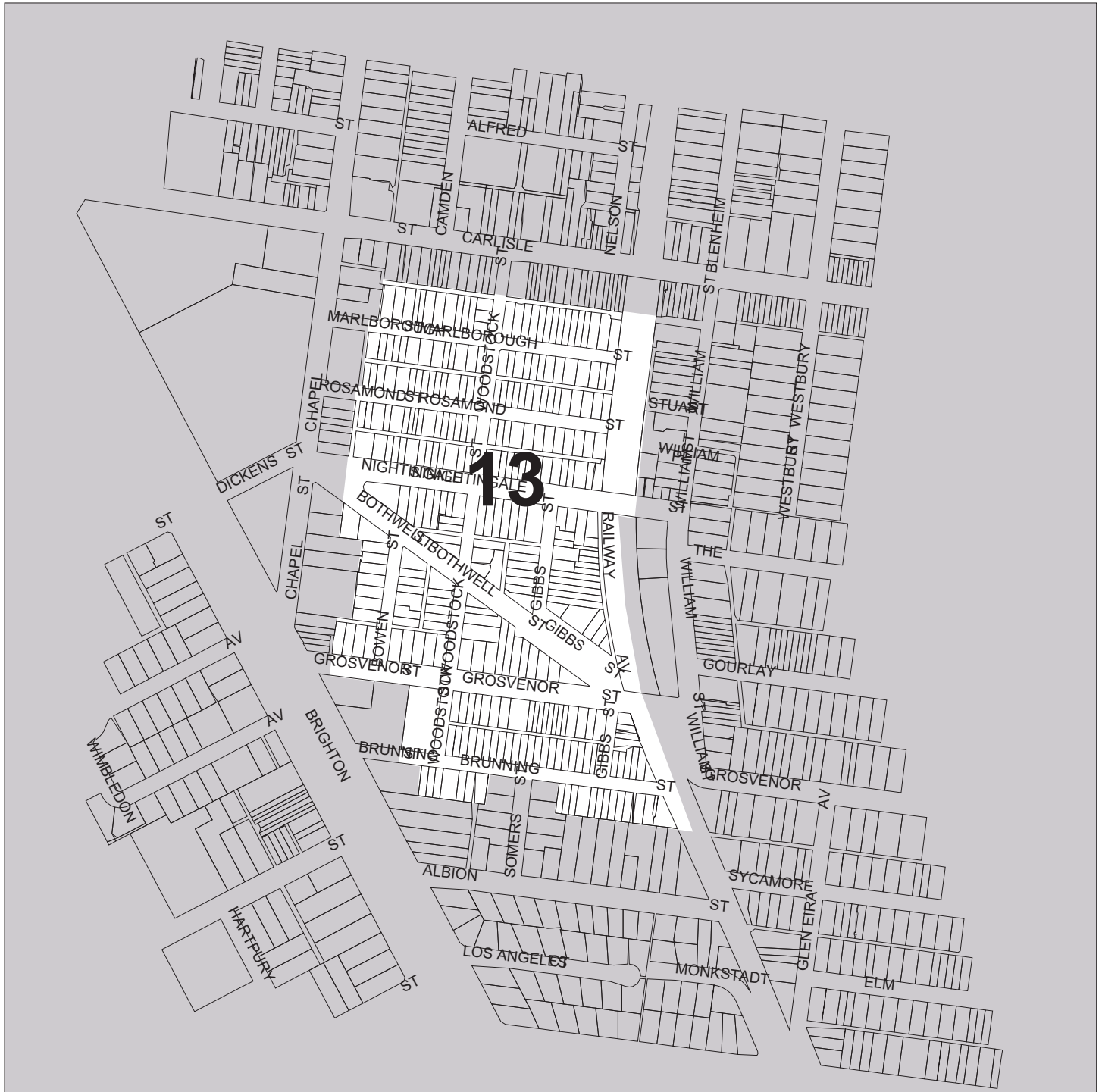

Chapel St, Carlisle St, Brunning St, Railway line.

Streets in the area:

BOTHWELL ST, BOWEN ST, BRUNNING ST, GIBBS ST, GROSVENOR ST, MARLBOROUGH ST, NIGHTINGALE ST, RAILWAY PL, ROSAMOND ST, SOMERS ST, WOODSTOCK ST,

Description of the character of the area:

The area was developed during the Victorian period, and is clearly distinguished from the adjoining inter-war housing to the west.

It has consistent small lots with small frontages, reduced setbacks and rear laneways. Most streets are quite narrow further reinforcing the intimate scale of the area.

Access to transport and services is excellent.

<i>Element</i>	<i>Description</i>
Dominant style	Pre-1900s
Dominant scale	one storey
Dominant material	timber or cladding/minor variation
Dominant roof	pitched/metal
Setback	less than 5 metres/consistent
Heritage	limited number of heritage places
Gardens	visible/small
Fences	low height/consistent materials

The existing urban character of the City of Port Phillip has been assessed using 24 character elements. The design should especially respond to the important and very important elements, which in this area are:

<i>Element</i>	<i>Importance</i>
Building style	Very important
Building scale	Very important
Lot size	Important
Pattern	Important
Street dimensions	Important
Parking	Important
Street detailing	Important
Overhead services	Important
Fences	Important
Setbacks	Important
Housing type	Important
Heritage	Important
Access	Important

A comprehensive urban character assessment and policy statement for the area is available from the Council .



City of Port Phillip
URBAN CHARACTER DESCRIPTION

AREA 14: LAND GENERALLY BOUNDED BY BRIGHTON ROAD, BRUNNING STREET, GLEN EIRA ROAD AND VICTORIA AVENUE, ST KILDA

The following description should be used in carrying out the site analysis and design response to your site. Pay attention to the very important and important character elements listed here, as well as the actual conditions observed at the site analysis stage.



Boundary streets:

Brighton Rd, Glen Eira, Brunning St.

Streets in the area:

Albion St, Glen Eira Rd, Los Angeles Ct, Maryville St, Monkstadt Av, Victoria Av,

Description of the character of the area:

This area is distinguished from adjoining areas to the north and south by its consistent larger lot sizes and the predominant inter-war building style.

Los Angeles Court, Monkstadt Avenue and part of Maryville Avenue represent an exceptional combination of interwar housing, gardens and streetscape. Other parts of this area were originally developed during the same era but have been modified by post-Second World War flat development.

The streets in the area vary in their dimensions, traffic flow and street trees. The area is close to a local shopping area and has good access to public transport.

<i>Element</i>	<i>Description</i>
Dominant style	1920s - 1940s
Dominant scale	one storey
Dominant material	stucco and render/minor variation
Dominant roof	pitched/terracotta
Setback	less than 5 metres/minor variation
Heritage	entire area identified as heritage place
Gardens	visible/medium
Fences	low height/consistent materials

The existing urban character of the City of Port Phillip has been assessed using 24 character elements. The design should especially respond to the important and very important elements, which in this area are:

<i>Element</i>	<i>Importance</i>
Building style	Very important
Heritage	Very important
Pattern	Important
Fences	Important
Front gardens	Important
Building scale	Important
Land use	Important
Access	Important

A comprehensive urban character assessment and policy statement for the area is available from the Council .



City of Port Phillip
URBAN CHARACTER DESCRIPTION

AREA 15: LAND GENERALLY BOUNDED BY VICTORIA AVENUE, LYNDON STREET, ERINDALE AVENUE AND BRIGHTON ROAD

The following description should be used in carrying out the site analysis and design response to your site. Pay attention to the very important and important character elements listed here, as well as the actual conditions observed at the site analysis stage.

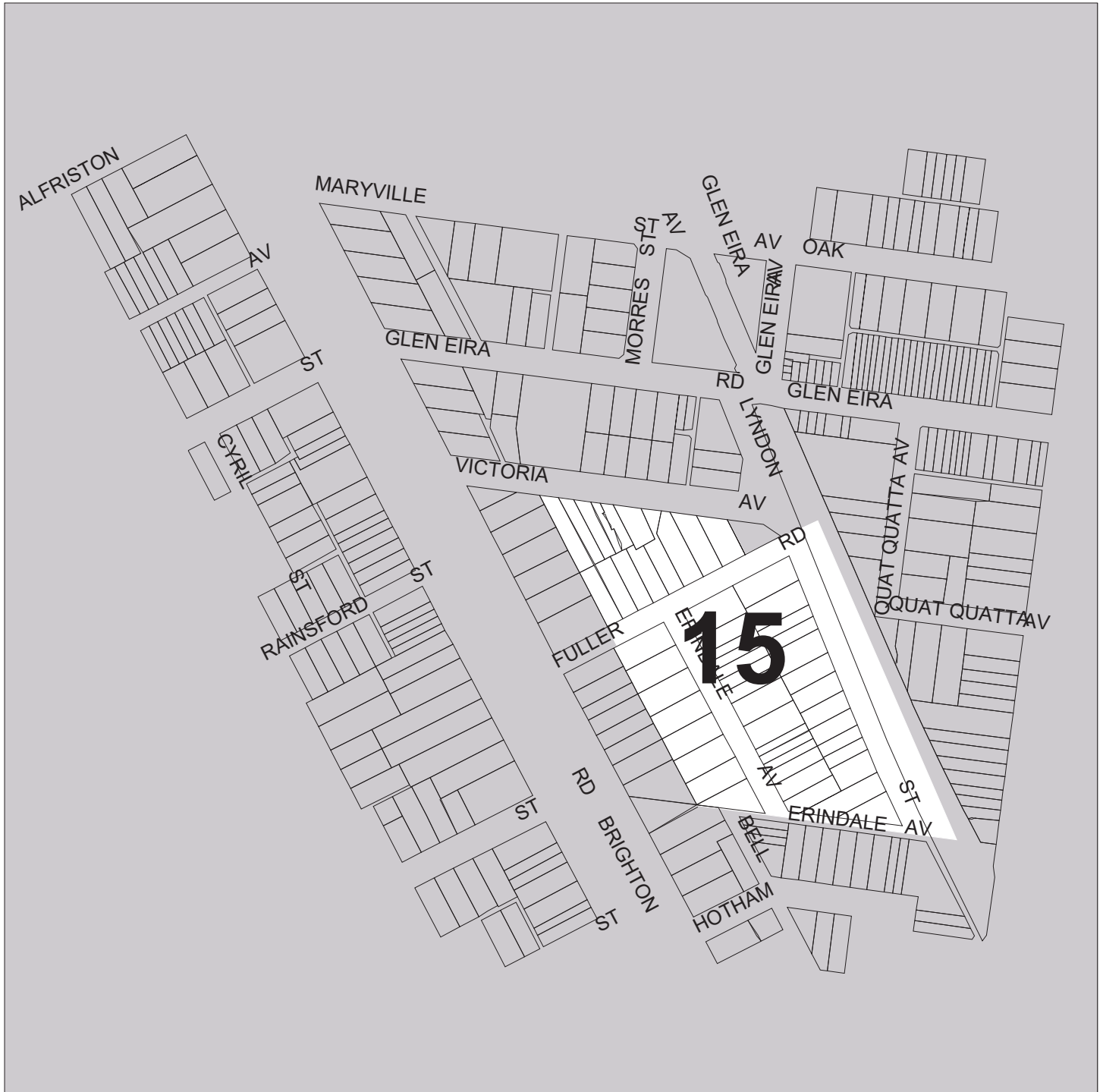

Boundary streets:

Victoria Ave, Erindale Ave, Railway line, Brighton Rd.

Streets in the area:

Erindale Av, Fuller Rd, Lyndon St,

Description of the character of the area:

Supporting a reasonably high population density, this small residential area is distinguished from adjoining areas to the north and south by its distorted subdivision pattern and relatively intact Edwardian and inter-war development.

Street detailing and street trees also contribute to the quality of the area.

The area is more distant from neighbourhood shopping centre, local community facilities and open space.

<i>Element</i>	<i>Description</i>
Dominant style	1900s - 1940s
Dominant scale	one storey
Dominant material	brick or masonry/consistent
Dominant roof	pitched/terracotta
Setback	5-9 metres/consistent
Heritage	entire area identified as heritage place
Gardens	visible/medium
Fences	medium height/various materials

The existing urban character of the City of Port Phillip has been assessed using 24 character elements. The design should especially respond to the important and very important elements, which in this area are:

<i>Element</i>	<i>Importance</i>
Building style	Very important
Building scale	Very important
Street trees	Important
Street detailing	Important
Fences	Important
Setbacks	Important
Front gardens	Important
Housing type	Important
Access	Important

A comprehensive urban character assessment and policy statement for the area is available from the Council .



City of Port Phillip
URBAN CHARACTER DESCRIPTION

AREA 16: LAND GENERALLY BOUND BY GLEN EIRA ROAD, BELL STREET, ERINDALE AVENUE AND HOTHAM STREET

The following description should be used in carrying out the site analysis and design response to your site. Pay attention to the very important and important character elements listed here, as well as the actual conditions observed at the site analysis stage.

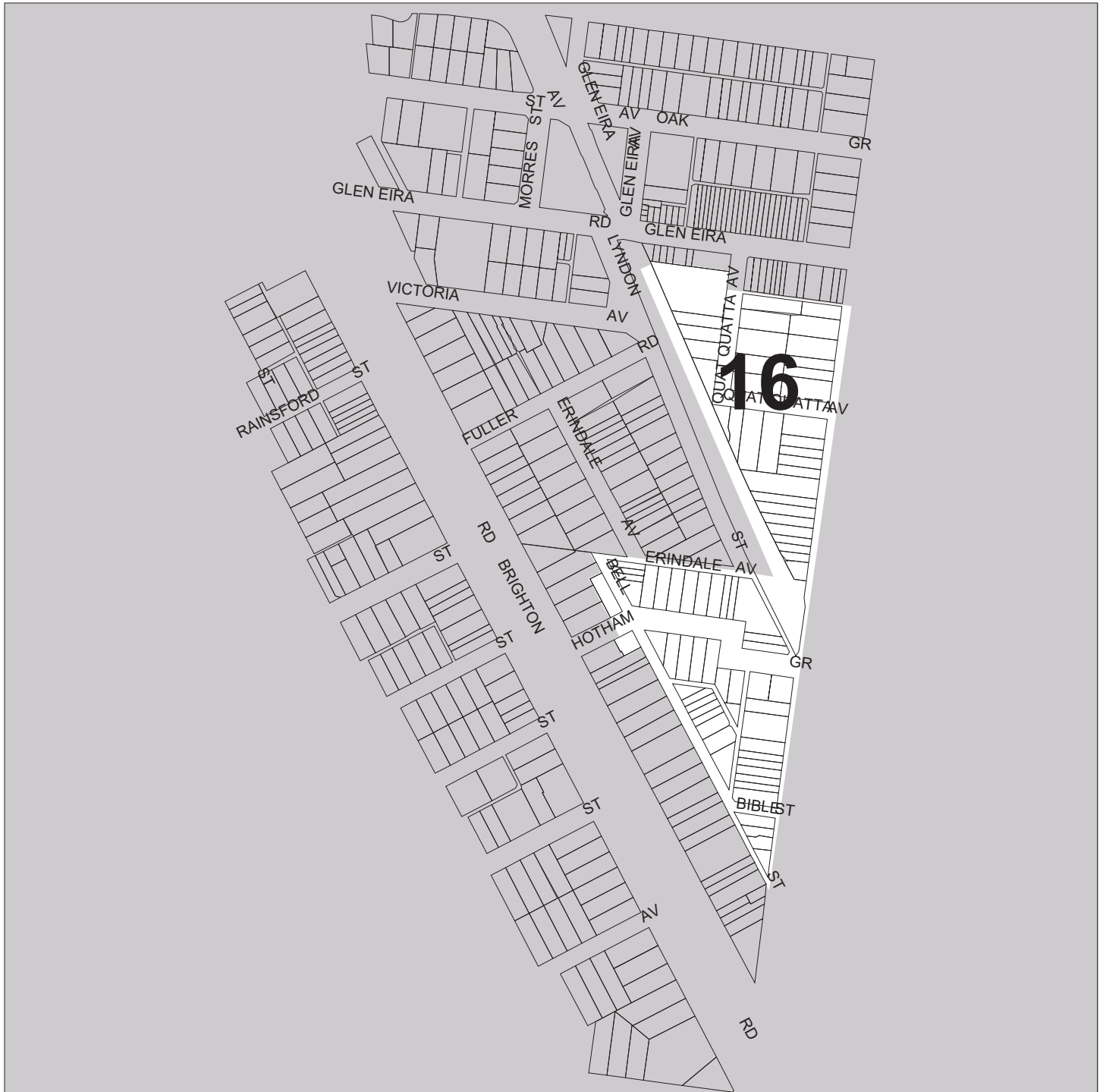

Boundary streets:

Bell St, Erindale Ave, Glen Eira Rd, Hotham St.

Streets in the area:

Bible St, Hotham Gv,

Description of the character of the area:

The entire area has undergone considerable redevelopment in the post war period with large walk-up flat blocks sitting side by side small timber cottages. This extremely varied scale is perhaps the area's most distinguishing characteristic.

The northern area includes the original Victorian homestead for the area with later development of suburban inter-war houses in the street. The southern area has been developed with more modest terraces or small timber cottages in the Victorian and Edwardian periods.

Streets and lanes are quite varied in scale, but most contain the original detailing. Street trees are also variable with excellent mature Plane trees in Quat Quatta Avenue and less successful planting of Ash and Paper barks in other streets.

The area has especially good access to shops and public transport.

<i>Element</i>	<i>Description</i>
Dominant style	1920s - 1940s
Dominant scale	one and two storey
Dominant material	brick or masonry/mixed
Dominant roof	pitched/terracotta
Setback	less than 5 metres/minor variation
Heritage	heritage places are located north of Quat Quatta Ave
Gardens	visible/medium/small
Fences	medium height/varied materials

The existing urban character of the City of Port Phillip has been assessed using 24 character elements. The design should especially respond to the important and very important elements, which in this area are:

<i>Element</i>	<i>Importance</i>
Building scale	Very important
Housing type	Important
Access	Important

A comprehensive urban character assessment and policy statement for the area is available from the Council .



City of Port Phillip
URBAN CHARACTER DESCRIPTION

AREA 17: GLEN EIRA ROAD AND VICTORIA AVENUE

The following description should be used in carrying out the site analysis and design response to your site. Pay attention to the very important and important character elements listed here, as well as the actual conditions observed at the site analysis stage.



Boundary streets:

Los Angeles Ct, Victoria Ave, Hotham Rd.

Streets in the area:

Glen Eira Av, Glen Eira Rd, Morres St, Quat Quatta Av,

Description of the character of the area:

This small area includes Ripponlea Station and its adjoining open space and streets with the Glen Eira shopping centre extending to the east of the railway station.

All development in this area was built in the decades immediately following the opening of the railway line in 1913. The shops are very consistent in their style, two storey scale and set back with little change since they were developed, apart from an unfortunate replacement building at the Hotham Road end.

The railway station buildings and small forecourt open spaces on both sides of the line create a strong sense of focus for the area. The park to the west of the line is edged with two storey flats on Glen Eira Road and single storey inter-war houses on Morres Street.

The area is quite distinct from adjoining residential areas, because of its shop use and consistent buildings and public focus.

<i>Element</i>	<i>Description</i>
Dominant style	1920s - 1940s
Dominant scale	two storey
Dominant material	brick or masonry/minor variation
Dominant roof	pitched/concealed by parapet
Setback	less than 5 metres/consistent
Heritage	entire area identified as heritage place
Gardens	visible/medium/small
Fences	low height/varied materials

The existing urban character of the City of Port Phillip has been assessed using 24 character elements. The design should especially respond to the important and very important elements, which in this area are:

<i>Element</i>	<i>Importance</i>
Building scale	Very important
Heritage	Very important
Views	Important
Parking	Important
Footpaths	Important
Overhead services	Important
Signage	Important
Fences	Important
Setbacks	Important
Land use	Important
Access	Important
Open space	Important

A comprehensive urban character assessment and policy statement for the area is available from the Council .



City of Port Phillip
URBAN CHARACTER DESCRIPTION

AREA 18: AREA GENERALLY BOUNDED BY HOTHAM STREET, OAK GROVE, RAILWAY LINE AND THE AVENUE

The following description should be used in carrying out the site analysis and design response to your site. Pay attention to the very important and important character elements listed here, as well as the actual conditions observed at the site analysis stage.

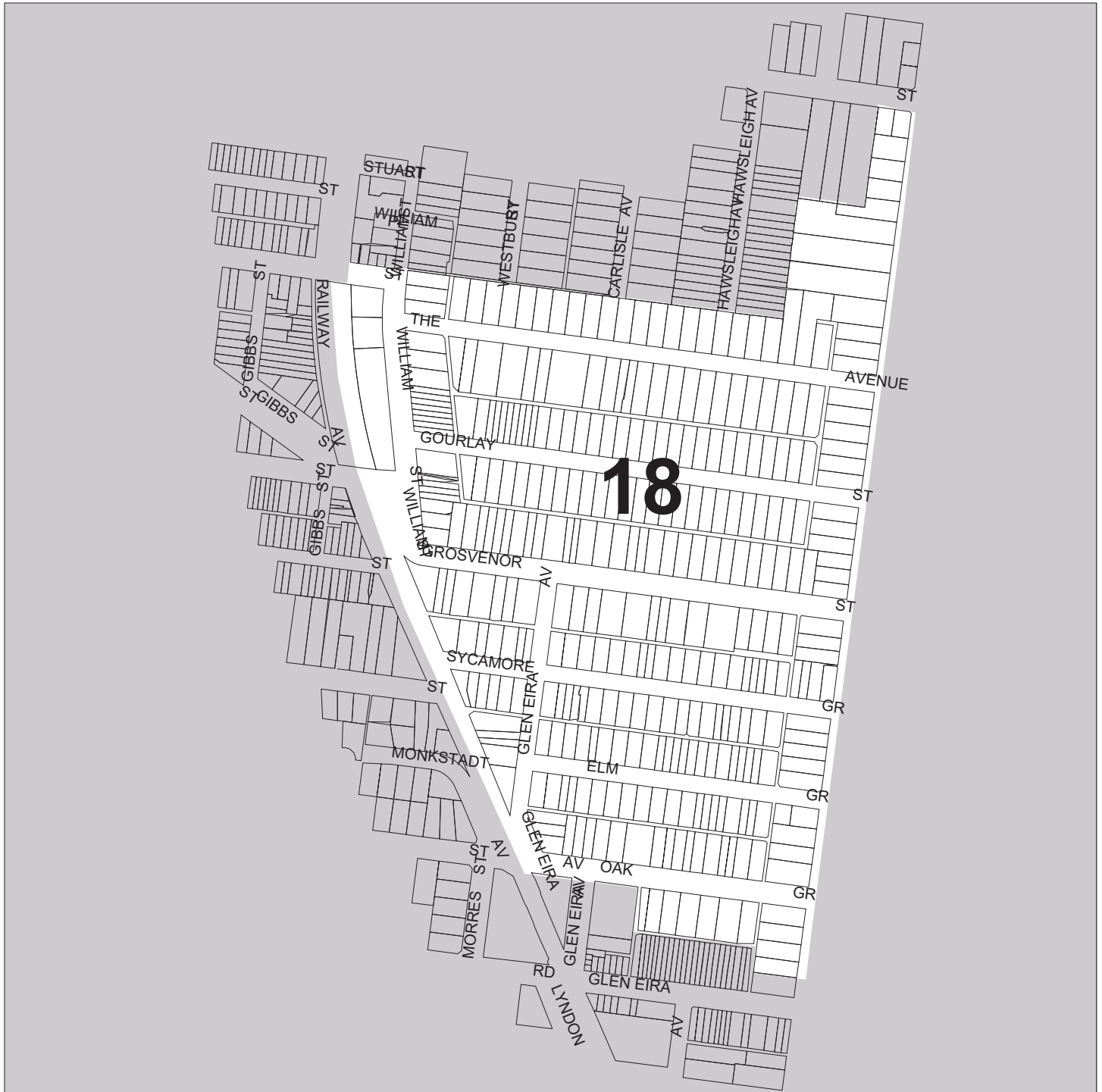

The Avenue, Hotham Rd, Oak Gve, Railway line.

Streets in the area:

Elm Gv, Gibbs St, Glen Eira Av, Gourlay St, Grosvenor St, Oak Gv, Sycamore Gv, The Avenue, William St,

Description of the character of the area:

The area was initially developed during Victorian, Edwardian and inter-war periods and pockets of each style remain. The area underwent substantial redevelopment with blocks of walk-up flats in the post war period and these now almost dominate its character.

The area also retains much of its original bluestone and bitumen street detailing, however traffic control devices and landscaping of questionable quality in some streets replace original details. Street trees are generally undersized mixed natives which do little to help unify these streets.

The area is somewhat distant from community facilities at its southern end and is lacking in open space.

<i>Element</i>	<i>Description</i>
Dominant style	1950s - 1960s
Dominant scale	one and two storey
Dominant material	brick or masonry/mixed
Dominant roof	pitched/terracotta
Setback	less than 5 metres/minor variation
Heritage	limited number of identified heritage places
Gardens	visible/medium/small
Fences	medium height/various materials

The existing urban character of the City of Port Phillip has been assessed using 24 character elements. The design should especially respond to the important and very important elements, which in this area are:

<i>Element</i>	<i>Importance</i>
Housing type	Very important
Pattern	Important
Parking	Important
Street detailing	Important
Building style	Important
Building scale	Important
Access	Important

A comprehensive urban character assessment and policy statement for the area is available from the Council .



City of Port Phillip
URBAN CHARACTER DESCRIPTION

AREA 19: CARLISLE STREET, EAST OF ST KILDA ROAD

The following description should be used in carrying out the site analysis and design response to your site. Pay attention to the very important and important character elements listed here, as well as the actual conditions observed at the site analysis stage.

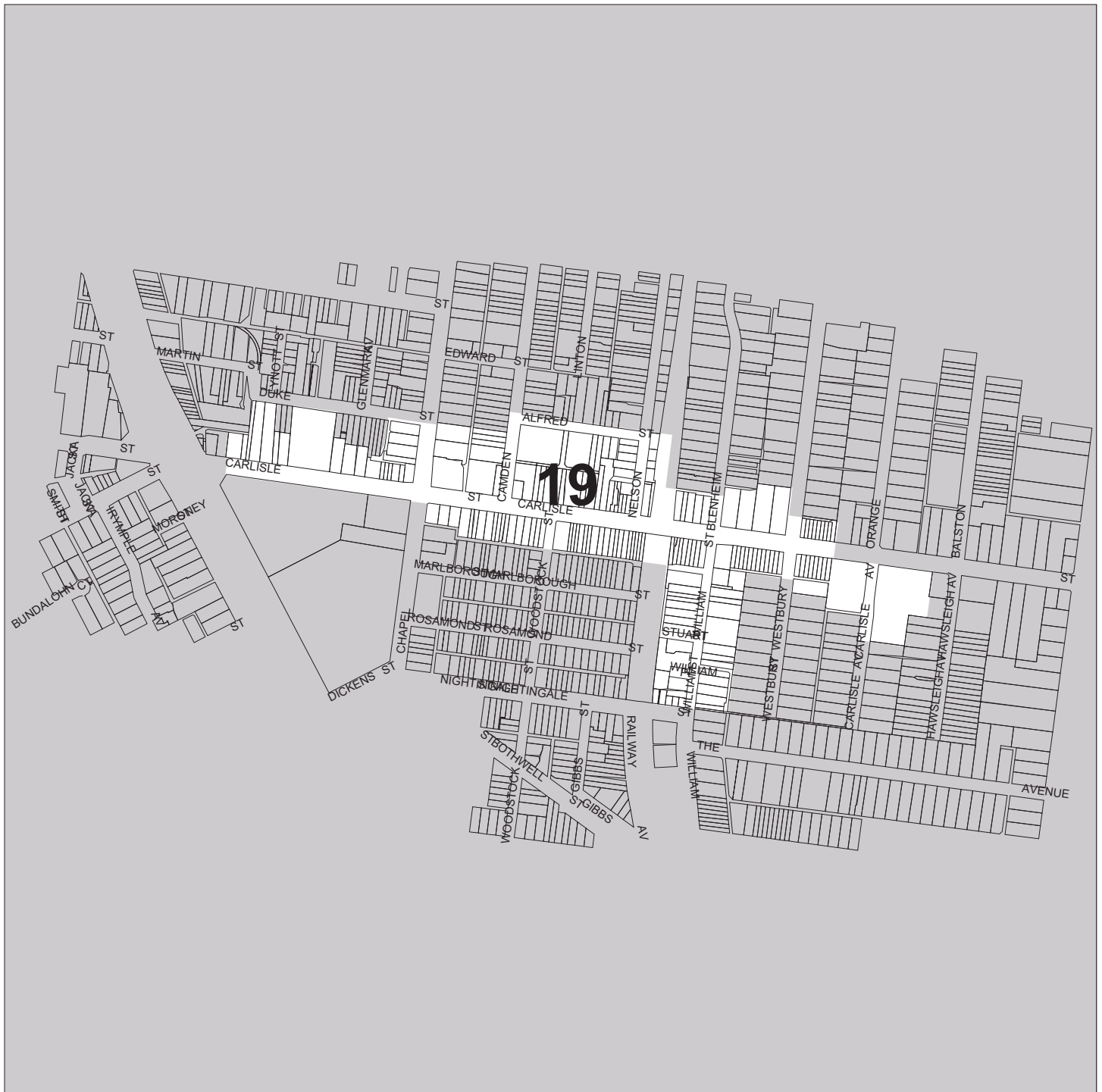

Boundary streets:

Alfred St, Duke St, St Kilda Rd, Nightingale St, Carslie St, Hawsleigh St.

Streets in the area:

Alfred St, Carlisle Av, Carlisle St, Stuart St, William Pl, William St,

Description of the character of the area:

The area is a classic urban village where a mix of residential, business and community uses exist in close proximity to public transport.

The frontage of Carlisle Street along most of this length is an active local shopping strip. The area also includes public car parks associated with the shopping and public facilities like the library, St Joseph's School and St Coleman's School, which is a landmark building at the high end of the street.

Whilst the residential areas surrounding this shopping centre are on the whole densely settled, opportunities for shop top housing and redevelopment of associated car parking lots exist.

There are also some industrial uses mostly on the south side of the shopping centre.

The centre appears to have been largely developed during the Edwardian and inter-war periods and whilst most of the building stock remains, it lacks a sense of cohesion due to the impact of signage and poor renovation.

Carlisle Street carries quite heavy traffic including trams and overhead services along both sides of the street have a strong visual presence.

<i>Element</i>	<i>Description</i>
Dominant style	1920s - 1940s
Dominant scale	one and two storey
Dominant material	stucco and render/minor variation
Dominant roof	pitched/metal
Setback	less than 5 metres/consistent
Heritage	includes considerable number of heritage places
Gardens	limited to schools and residential properties
Fences	none

The existing urban character of the City of Port Phillip has been assessed using 24 character elements. The design should especially respond to the important and very important elements, which in this area are:

<i>Element</i>	<i>Importance</i>
Signage	Very important
Land use	Very important
Access	Very important
Lot size	Important
Street dimensions	Important
Traffic	Important
Parking	Important
Overhead services	Important
Fences	Important
Setbacks	Important
Building style	Important
Building scale	Important

A comprehensive urban character assessment and policy statement for the area is available from the Council .



City of Port Phillip
URBAN CHARACTER DESCRIPTION

AREA 20: LAND GENERALLY BOUNDED BY THE AVENUE, RAILWAY LINE, ALMA ROAD AND MARNE STREET

The following description should be used in carrying out the site analysis and design response to your site. Pay attention to the very important and important character elements listed here, as well as the actual conditions observed at the site analysis stage.

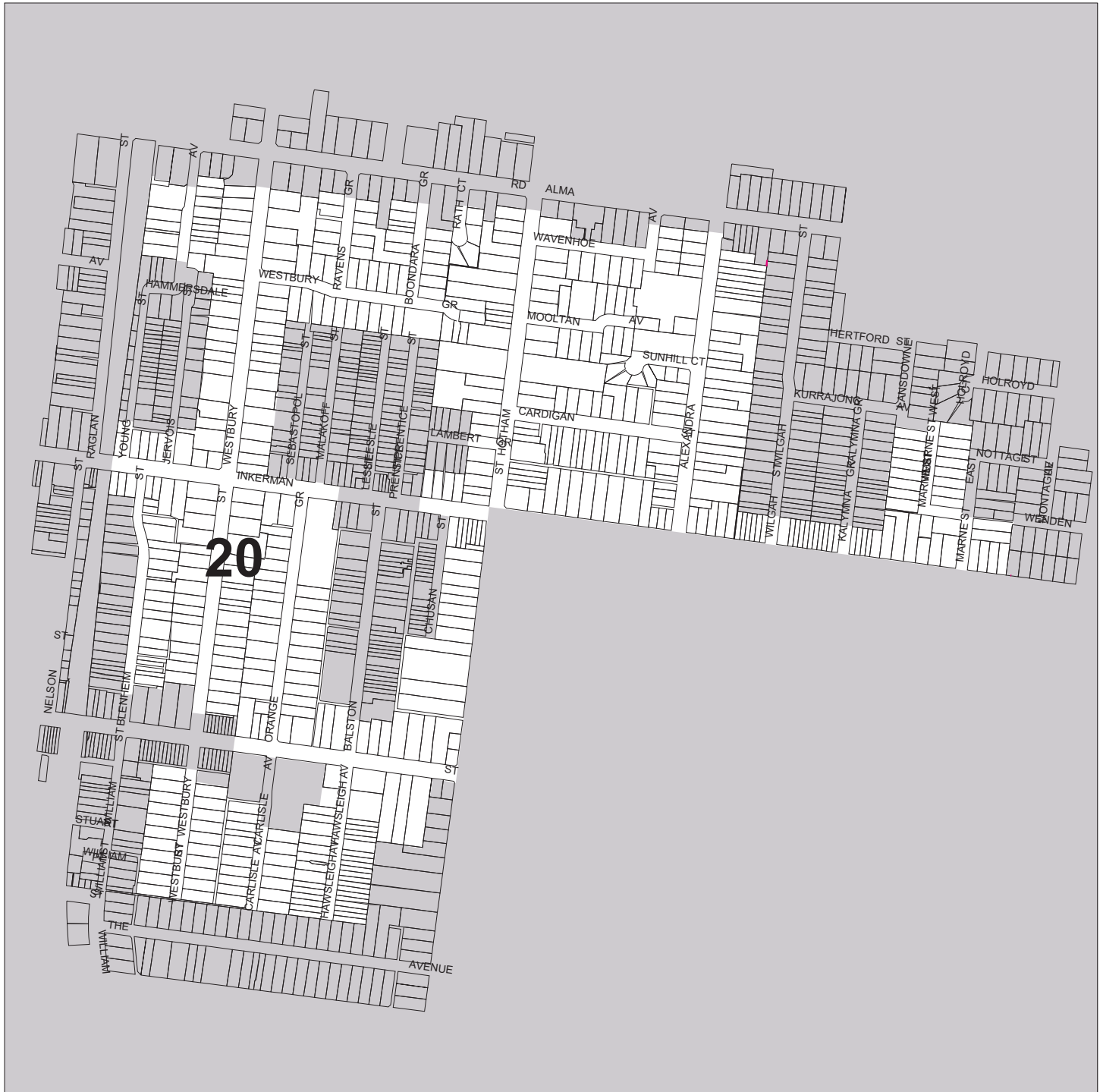

The Avenue, Hotham Rd, Marne St East, Alma Rd, Railway line.

Streets in the area:

Alexandra St, Blenheim St, Cardigan St, Carlisle St, Chusan St, Hammerdale Av, Hawsleigh Av, Hotham St, Inkerman St, Lansdowne Rd, Mooltan Av, Orange Gv, Sunhill Ct, Wavenhoe Av, Westbury Gv, Westbury St,

Description of the character of the area:

Whilst initially developed during Victorian, Edwardian and inter-war periods with detached housing on large lots, substantial redevelopment in the post-war period with a high proportion of walk-up flat blocks has changed the residential density, scale and character of streetscapes.

Many of the streets in the area are wide and carry considerable traffic. Much of the original bluestone and bitumen street detailing remains, however, replacement concrete kerbs and driveway crossings are also common. Parking in the street is visually significant in this area.

Street trees are quite patchy and generally out of scale with the street spaces. Exceptions to this are Westbury Street (south of Carlisle Street), and Westbury and Carlisle Avenues.

<i>Element</i>	<i>Description</i>
Dominant style	1950s - 1960s
Dominant scale	one, two and three stories
Dominant material	brick or masonry/mixed
Dominant roof	pitched/terracotta
Setback	less than 5 metres/mixed
Heritage	limited number of heritage places identified
Gardens	visible/medium/small
Fences	medium/variable materials

The existing urban character of the City of Port Phillip has been assessed using 24 character elements. The design should especially respond to the important and very important elements, which in this area are:

<i>Element</i>	<i>Importance</i>
Building scale	Very important
Housing type	Very important
Lot size	Important
Street dimensions	Important
Traffic	Important
Parking	Important
Setbacks	Important
Building style	Important
Access	Important

A comprehensive urban character assessment and policy statement for the area is available from the Council .



City of Port Phillip
URBAN CHARACTER DESCRIPTION

AREA 21: LAND GENERALLY BOUNDED BY WESTBURY GROVE, HOTHAM STREET, CARLISLE STREET, ORANGE GROVE AND WESTBURY STREET

The following description should be used in carrying out the site analysis and design response to your site. Pay attention to the very important and important character elements listed here, as well as the actual conditions observed at the site analysis stage.

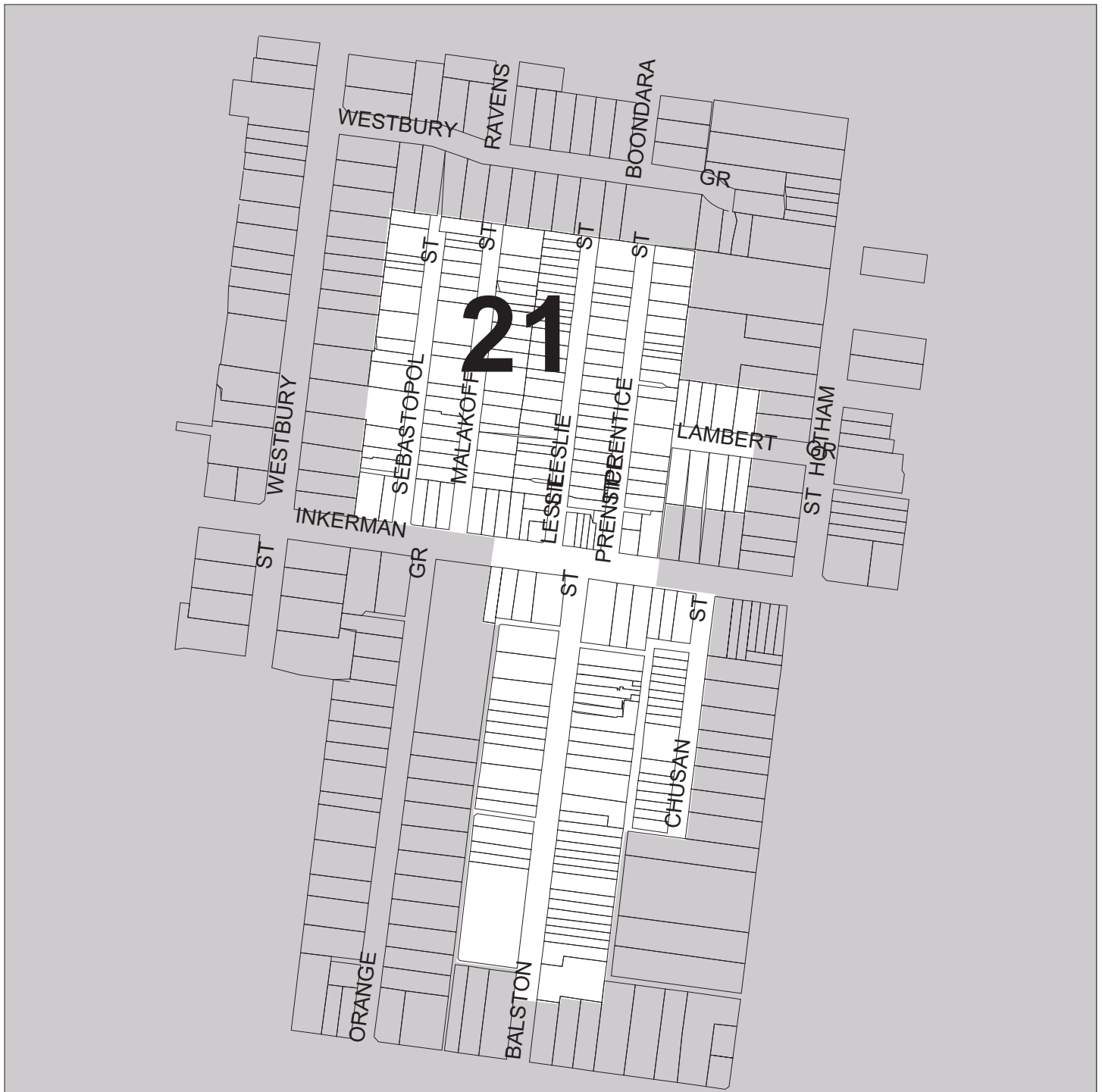

Boundary streets:

Westbury Gve, Carlisle St, Sebastopol St, Chusan St.

Streets in the area:

Balston St, Inkerman St, Lambert Gv, Leslie St, Malakoff St, Prentice St, Sebastopol St,

Description of the character of the area:

This small area is primarily distinguished from surrounding area by its narrow streets, smaller lots and a limited number of flat blocks intermingled with modest housing.

It includes buildings from all periods since the Victorian era and more particularly, Victorian timber workers' cottages with heritage interest.

The area has commercial and industrial uses on Inkerman Street and most streets do not connect through to adjoining areas, effectively being cul-de-sacs off Inkerman Street.

The streets retain much of their original detailing and the recent introduction of street trees has limited influence on the character of the area.

Access to a neighbourhood shopping centre, community services and transport is limited in the area north of Inkerman Street.

<i>Element</i>	<i>Description</i>
Dominant style	pre-1900s
Dominant scale	one storey
Dominant material	timber or cladding/mixed
Dominant roof	pitched/metal
Setback	less than 5 metres/consistent
Heritage	virtually no heritage places identified
Gardens	visible/small
Fences	medium height/varied materials

The existing urban character of the City of Port Phillip has been assessed using 24 character elements. The design should especially respond to the important and very important elements, which in this area are:

<i>Element</i>	<i>Importance</i>
Lot size	Very important
Setbacks	Very important
Building scale	Very important
Pattern	Important
Street dimensions	Important
Parking	Important
Fences	Important
Building style	Important
Housing type	Important
Land use	Important
Access	Important

A comprehensive urban character assessment and policy statement for the area is available from the Council .



City of Port Phillip
URBAN CHARACTER DESCRIPTION

AREA 22: ALMA ROAD BETWEEN ST KILDA ROAD AND ORRONG ROAD

The following description should be used in carrying out the site analysis and design response to your site. Pay attention to the very important and important character elements listed here, as well as the actual conditions observed at the site analysis stage.



Boundary streets:

Alma Rd, St Kilda Rd, Orrong Rd.

Streets in the area:

Alma Pl, Alma Rd, Boondara Gv, Holroyd Av, Hotham St, Raglan St, Raith Ct, Ravens Gv,

Description of the character of the area:

The area was initially developed with many large Victorian mansions built at the western end of Alma Road and more suburban housing from the inter-war period at the eastern end.

As many of the lots are large, extensive redevelopment with walk-up flat blocks, mostly in the post-war period, now dominates the character of many sections of this area.

This section of Alma Road has a wide reservation and wide carriageway and carries quite heavy volumes of through traffic.

To facilitate the heavy volumes of through traffic, the road has been widened with concrete kerbs and footpaths replacing original details, and nature strips narrowed or removed, leaving little space for the remaining few mature trees.

Overhead services also have a strong visual impact in this area due to the recent plantings of mixed natives being too small for the street.

Alma Park and the St Kilda cemetery on the north side of Alma Road makes a significant contribution to the area's character.

<i>Element</i>	<i>Description</i>
Dominant style	1950s - 1960s
Dominant scale	one and two storey
Dominant material	brick or masonry/mixed
Dominant roof	pitched/terracotta
Setback	less than 5 metres/mixed
Heritage	includes number of identified heritage places
Gardens	visible/large/medium/small
Fences	medium-high/various materials

The existing urban character of the City of Port Phillip has been assessed using 24 character elements. The design should especially respond to the important and very important elements, which in this area are:

<i>Element</i>	<i>Importance</i>
Housing type	Very important
Lot size	Important
Street dimensions	Important
Traffic	Important
Overhead services	Important
Front gardens	Important
Building scale	Important
Open space	Important

A comprehensive urban character assessment and policy statement for the area is available from the Council .



City of Port Phillip
URBAN CHARACTER DESCRIPTION

AREA 23: ARDOCH

The following description should be used in carrying out the site analysis and design response to your site. Pay attention to the very important and important character elements listed here, as well as the actual conditions observed at the site analysis stage.

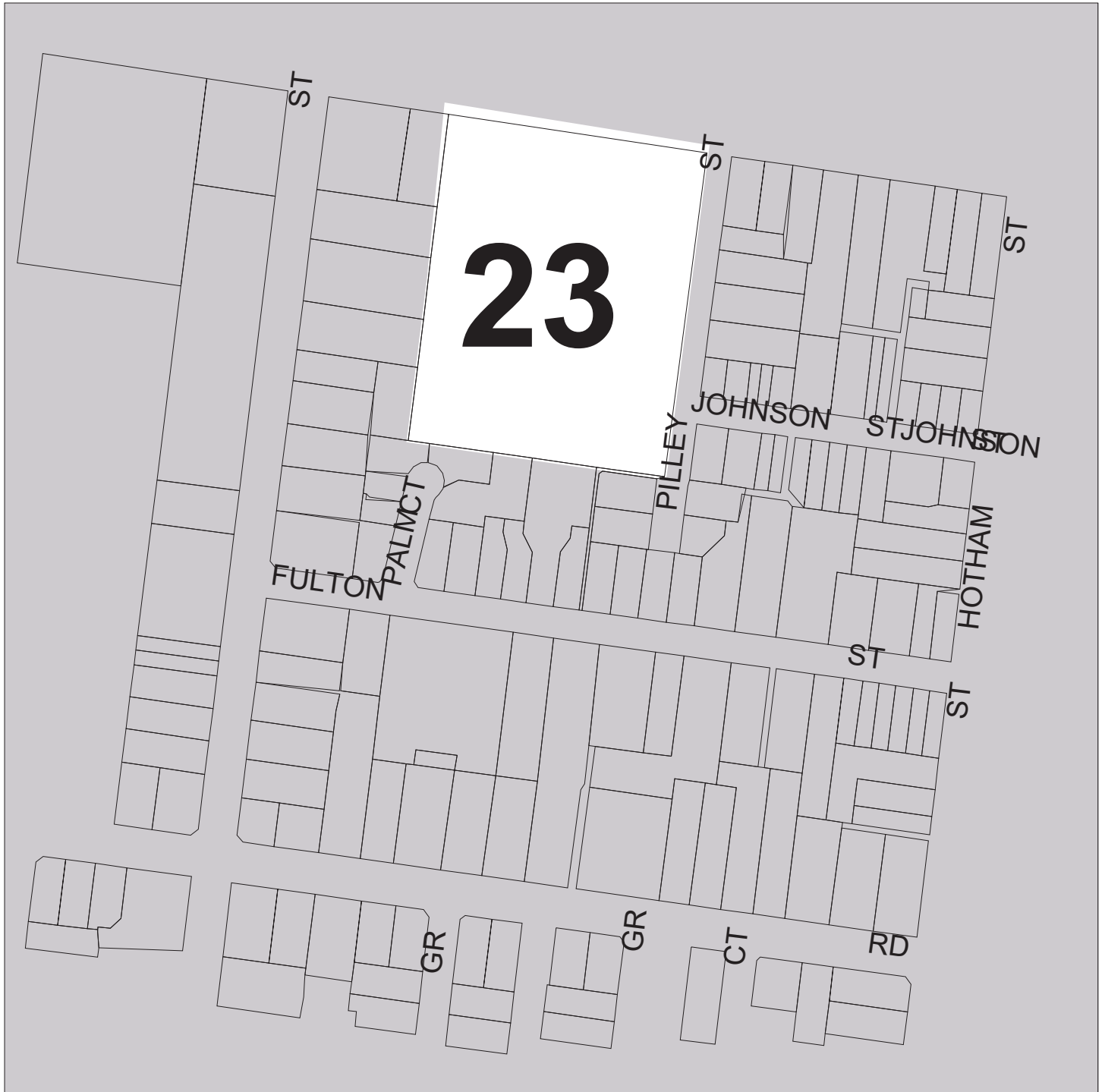

Boundary streets:

Ardoch Ave, Pilley St, Dandenong Rd.

Streets in the area:

Ardoch Av, Palm Ct,

Description of the character of the area:

The area is distinctive from adjoining areas because it is a comprehensive single development site.

It was initially developed in the Victorian period as large houses surrounded by gardens and later, during the inter-war period, was subdivided and redeveloped as an institutional complex. The most recent phase of redevelopment in the 1990's relates to the construction of new buildings along the Pilley Street frontage and the conversion of other buildings into apartments.

The internal landscape of the site has been totally redesigned to provide an integrated garden with limited narrow access roads to garages and parking spaces.

<i>Element</i>	<i>Description</i>
Dominant style	1920s - 1940s
Dominant scale	two storey
Dominant material	stucco and render/consistent
Dominant roof	pitched/terracotta
Setback	5-9 metres/varied
Heritage	identified as a heritage place
Gardens	visible/large
Fences	medium height/varied materials

The existing urban character of the City of Port Phillip has been assessed using 24 character elements. The design should especially respond to the important and very important elements, which in this area are:

<i>Element</i>	<i>Importance</i>
Front gardens	Very important
Building style	Very important
Building scale	Very important
Heritage	Very important
Open space	Very important
Views	Important
Lot size	Important
Street dimensions	Important
Street detailing	Important
Housing type	Important
Land use	Important
Access	Important

A comprehensive urban character assessment and policy statement for the area is available from the Council .



City of Port Phillip
URBAN CHARACTER DESCRIPTION

AREA 24: LAND GENERALLY BOUNDED BY ORRONG ROAD, ALMA ROAD, INKERMAN STREET AND WILGAH STREET, ST KILDA

The following description should be used in carrying out the site analysis and design response to your site. Pay attention to the very important and important character elements listed here, as well as the actual conditions observed at the site analysis stage.

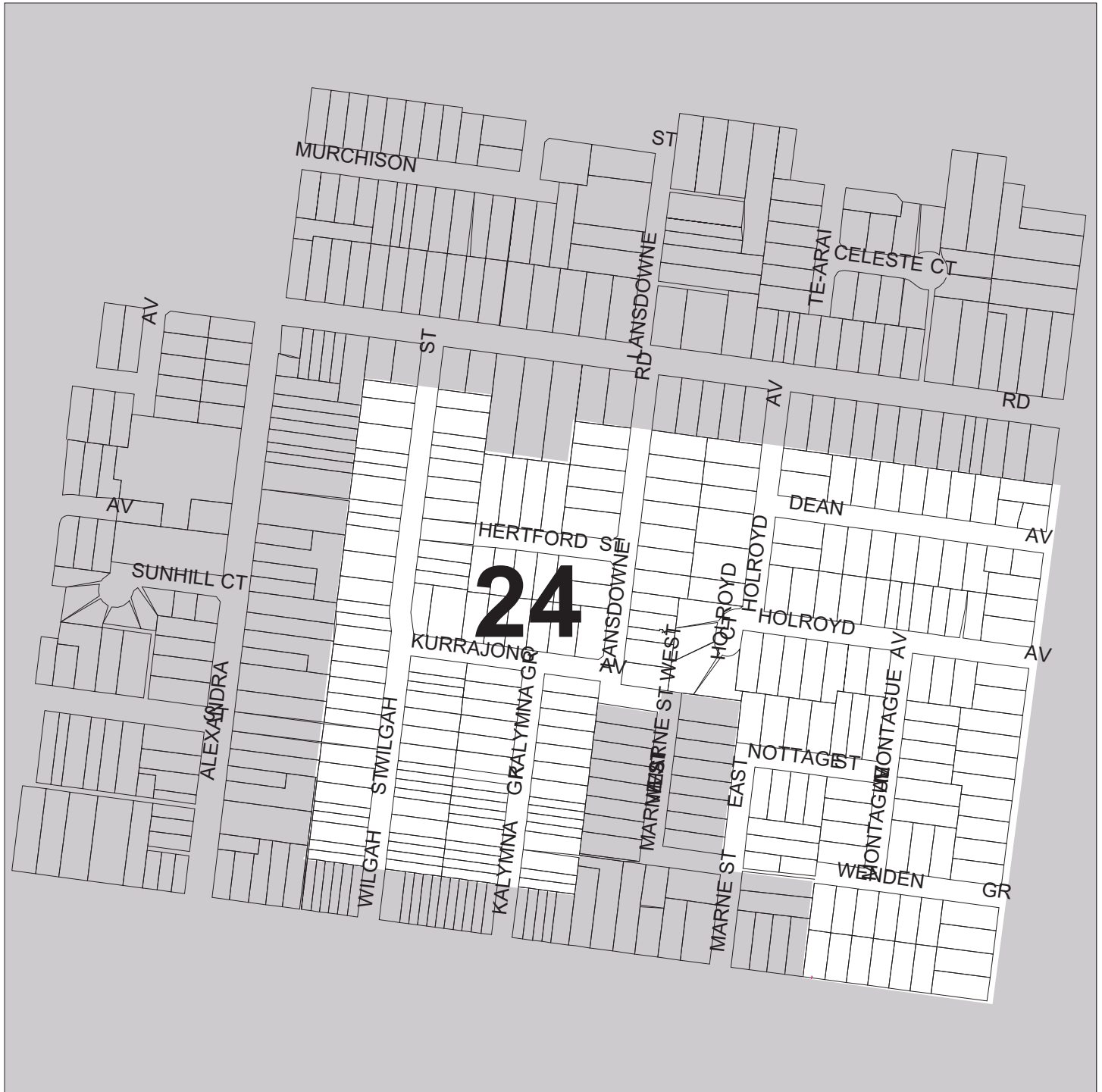

Boundary streets:

Orrong Rd, Alma Rd, Wilgah St, Inkerman St.

Streets in the area:

Dean Av, Hertford St, Holroyd Av, Holroyd Ct, Kalymna Gv, Kurrajong Av, Lansdowne Rd, Marne St, Montague Av, Nottage St, Wenden Gv, Wilgah St,

Description of the character of the area:

This area was primarily developed in the inter-war period with a fairly consistent subdivision pattern. The area still retains most of its original housing stock of medium sized brick and stucco detached houses with attractive front gardens and consistent front fencing.

There is some redevelopment with flat blocks in Wilgah Street, however the balance of the area is relatively free from walk-up flat buildings and new replacement housing.

The western and southern parts of this area are quite steeply sloping adding to the interest of the streetscapes.

Streets are consistent in their scale and most retain their original bluestone kerbs and channels. Street trees include a mix of species that vary in size however the overall effect provides an established streetscape appearance. The area includes some exceptional flowering gum specimens.

<i>Element</i>	<i>Description</i>
Dominant style	1920s - 1940s
Dominant scale	one storey
Dominant material	stucco and render/minor variation
Dominant roof	pitched/terracotta
Setback	5-9 metres/minor variation
Heritage	no heritage place identified
Gardens	visible/medium
Fences	low-medium height/varied materials

The existing urban character of the City of Port Phillip has been assessed using 24 character elements. The design should especially respond to the important and very important elements, which in this area are:

<i>Element</i>	<i>Importance</i>
Landform	Very important
Front gardens	Very important
Building style	Very important
Building scale	Very important
Views	Important
Pattern	Important
Street trees	Important
Setbacks	Important
Housing type	Important

A comprehensive urban character assessment and policy statement for the area is available from the Council .



City of Port Phillip
URBAN CHARACTER DESCRIPTION

AREA 25: MURCHISON STREET, ST KILDA

The following description should be used in carrying out the site analysis and design response to your site. Pay attention to the very important and important character elements listed here, as well as the actual conditions observed at the site analysis stage.

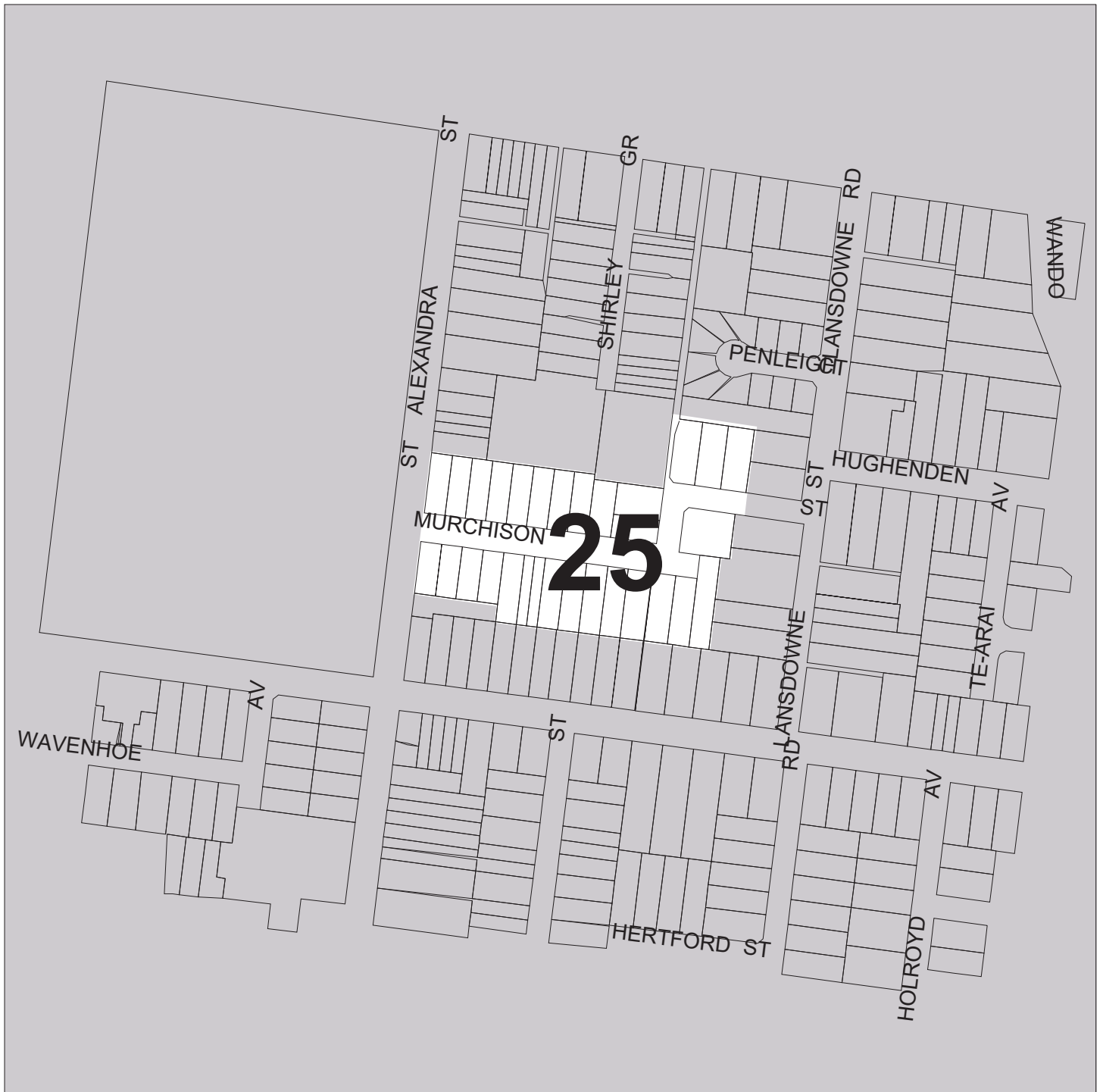

Alexandra St, Lansdowne St, Murchison St.

Streets in the area:

Murchison St,

Description of the character of the area:

Developed during the inter-war period, the area retains much of its original housing stock comprising detached houses and apartments with attractive front gardens and consistent front fences.

Most of this area slopes steeply to the west which adds to the interest of the streetscapes.

Streets flanked by large plane trees retain the original bluestone kerbs, channels, bitumen footpaths and some bitumen crossovers.

<i>Element</i>	<i>Description</i>
Dominant style	1920s - 1940s
Dominant scale	one storey
Dominant material	stucco and render/minor variation
Dominant roof	pitched/terracotta
Setback	5-9 metres/consistent
Heritage	no identified heritage places
Gardens	visible/medium
Fences	low height/consistent

The existing urban character of the City of Port Phillip has been assessed using 24 character elements. The design should especially respond to the important and very important elements, which in this area are:

<i>Element</i>	<i>Importance</i>
Landform	Very important
Street trees	Very important
Front gardens	Very important
Building style	Very important
Pattern	Important
Fences	Important
Setbacks	Important
Building scale	Important
Housing type	Important
Heritage	Important
Land use	Important

A comprehensive urban character assessment and policy statement for the area is available from the Council .



City of Port Phillip
URBAN CHARACTER DESCRIPTION

AREA 26: LAND GENERALLY BOUNDED BY ORRONG ROAD, ALMA ROAD. ALEXANDRA STREET AND DANDENONG ROAD, ST KILDA

The following description should be used in carrying out the site analysis and design response to your site. Pay attention to the very important and important character elements listed here, as well as the actual conditions observed at the site analysis stage.

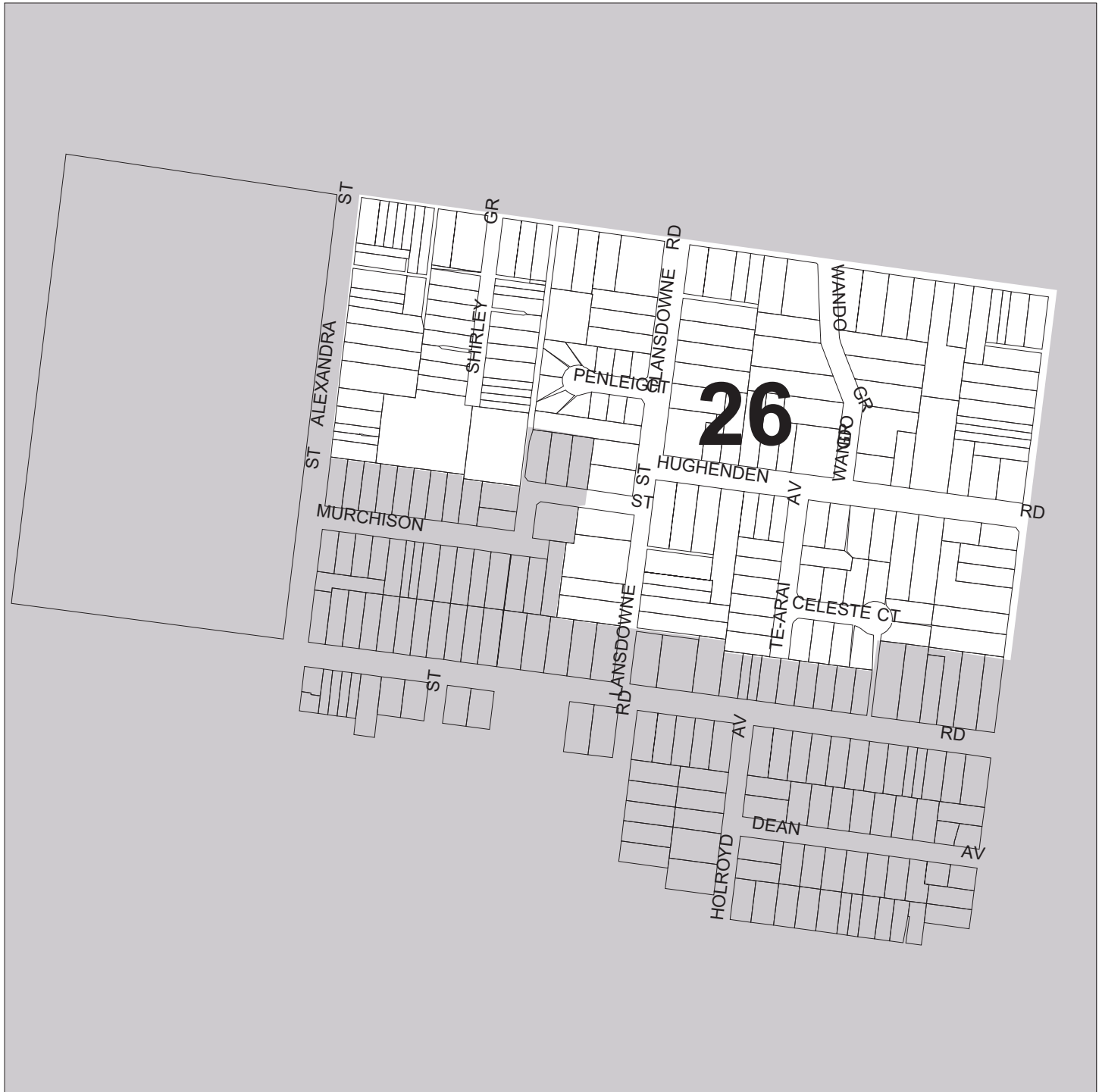

Boundary streets:

Dandenong Rd, Orrong Rd, Alma Rd, Alexandra St.

Streets in the area:

Alexandra St, Celeste Ct, Hughenden Rd, Lansdowne Rd, Penleigh Ct, Shirley Gv, Te-arai Av, Wando Gv,

Description of the character of the area:

The area appears to have been subdivided and developed in the Edwardian and inter-war period, with a high proportion of large allotments. These large lots attracted extensive redevelopment during the 1960's and 1970's with two and three storey walk-up flat blocks dominating the character of the area. The area now has a diverse mix of building types and styles at various set backs and height levels.

Streets were originally developed with bluestone kerbs, channels and nature strips, however, many now have concrete footpaths, crossings and kerbs .

The area has some mature street trees including flowering gum, liquid amber and others, although recent plantings with small scale mixed natives has changed the character to a certain degree.

<i>Element</i>	<i>Description</i>
Dominant style	1950s - 1960s
Dominant scale	one, two and three storey
Dominant material	brick or masonry/mixed
Dominant roof	flat/metal
Setback	less than 5 metres/mixed
Heritage	limited number of heritage places
Gardens	visible/medium/small
Fences	various heights/various materials

The existing urban character of the City of Port Phillip has been assessed using 24 character elements. The design should especially respond to the important and very important elements, which in this area are:

<i>Element</i>	<i>Importance</i>
Housing type	Very important
Lot size	Important
Street trees	Important
Building scale	Important
Access	Important

A comprehensive urban character assessment and policy statement for the area is available from the Council .



City of Port Phillip
URBAN CHARACTER DESCRIPTION

AREA 27: LAND GENERALLY BOUNDED BY DANDENONG ROAD, HOTHAM STREET, FULTON STREET AND WESTBURY STREET, ST KILDA

The following description should be used in carrying out the site analysis and design response to your site.
Pay attention to the very important and important character elements listed here, as well as the actual conditions observed at the site analysis stage.

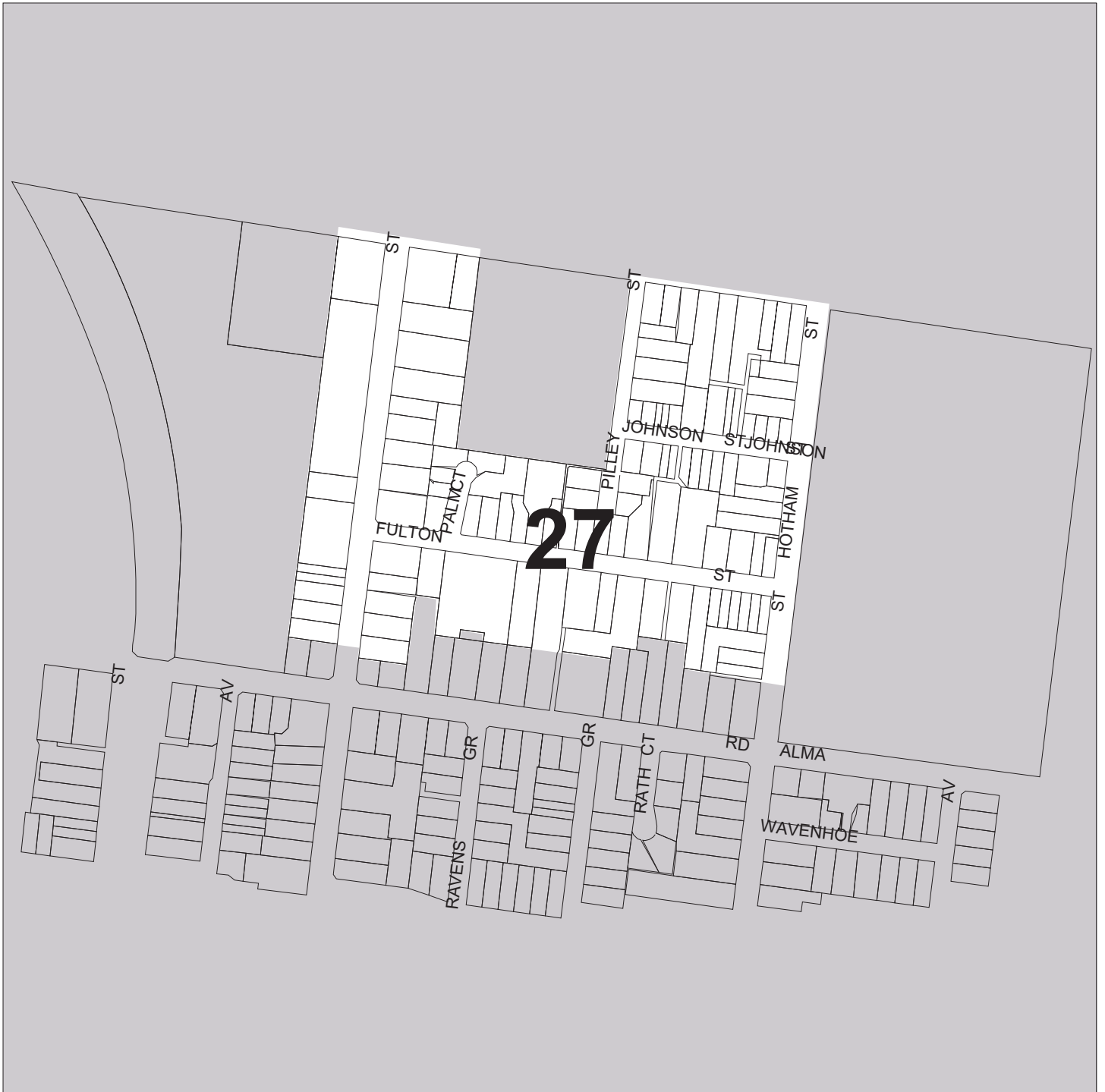

Boundary streets:

Dandenong Rd, Fulton St, Westbury St, Hotham St.

Streets in the area:

Fulton St, Johnson St, Pilley St, Westbury St,

Description of the character of the area:

The area has been subdivided and developed in many stages from the time of its original development. This is reflected in the wide range of lot sizes although the lots are predominantly large.

Whilst the large lots have attracted extensive redevelopment in both the inter-war and post-war periods with large apartment blocks dominating the character of the area, small pockets of the area remain intact from the original phase of development. Johnson and Reilly Streets contain consistent housing from the Edwardian and inter-war periods and Palm Court is a fine example of inter-war houses and flats.

The streets are medium to wide in their scale and still retain original bluestone kerb and channel detailing. These are partially diminished by the numerous concrete crossovers and some sections of concrete footpaths.

Street trees in this area are generally inconsistent and out of scale with the streets.

<i>Element</i>	<i>Description</i>
Dominant style	1950s -1960s
Dominant scale	three storey
Dominant material	brick or masonry/mixed
Dominant roof	pitched/metal
Setback	less than 5 metres/varied
Heritage	some identified heritage places
Gardens	visible/medium/small
Fences	low height/various materials

The existing urban character of the City of Port Phillip has been assessed using 24 character elements. The design should especially respond to the important and very important elements, which in this area are:

<i>Element</i>	<i>Importance</i>
Building scale	Very important
Housing type	Very important
Lot size	Important
Parking	Important
Setbacks	Important
Building style	Important
Access	Important

A comprehensive urban character assessment and policy statement for the area is available from the Council .



City of Port Phillip
URBAN CHARACTER DESCRIPTION

AREA 28: LAND GENERALLY BOUND BY ALFRED STREET, CHAPEL STREET, ALMA ROAD AND JERVOIS STREET, ST KILDA

The following description should be used in carrying out the site analysis and design response to your site. Pay attention to the very important and important character elements listed here, as well as the actual conditions observed at the site analysis stage.

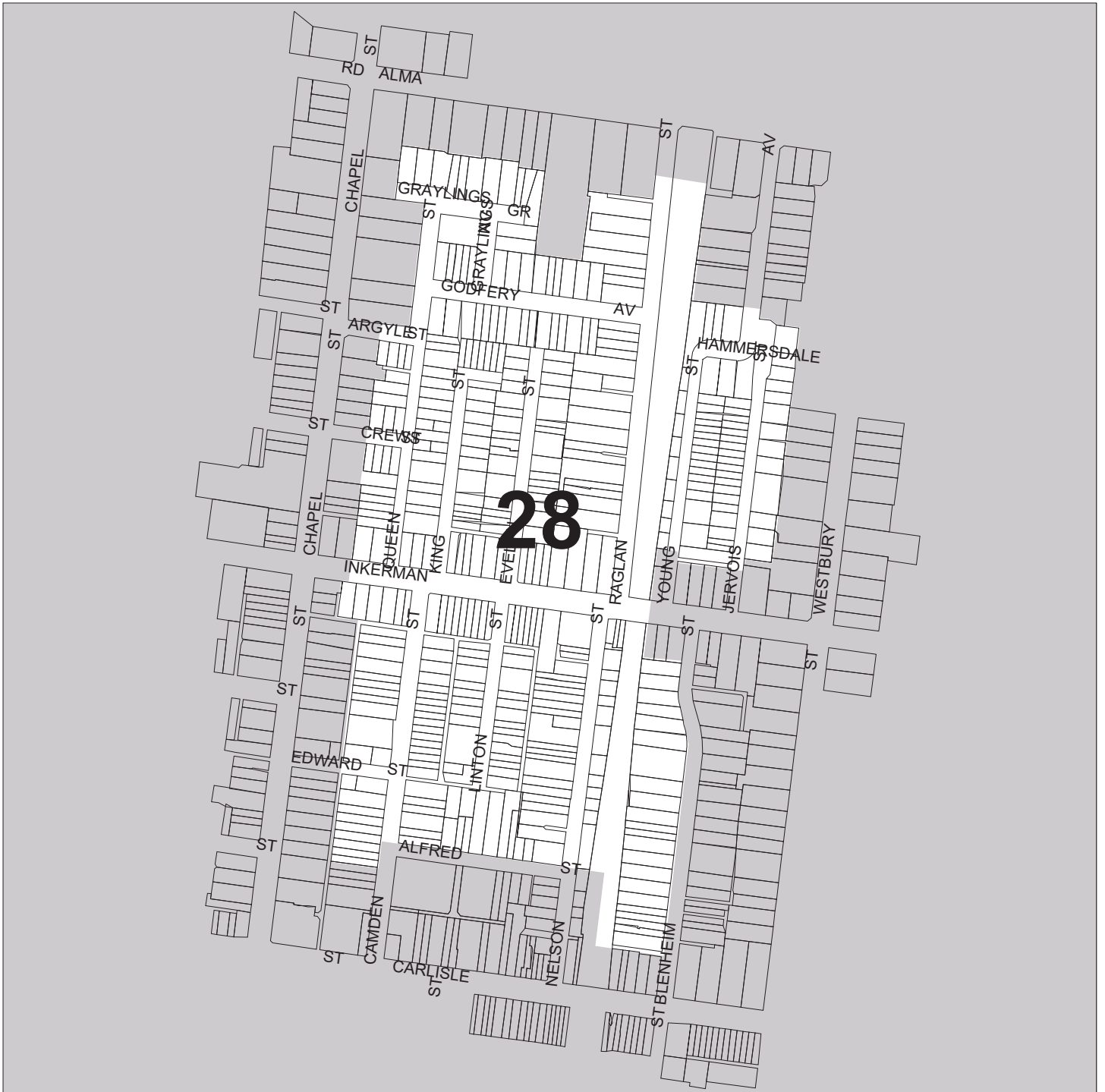

Boundary streets:

Alfred St, Chapel St, Alma Rd, Jervois St.

Streets in the area:

Camden St, Evelyn St, Godfrey Av, Graylings Av, Graylings Gv, Inkerman St, Jervois St, King St, Linton St, Nelson St, Phillips St, Queen St, Raglan St, Young St,

Description of the character of the area:

The area is distinguished from adjoining areas by its smaller scale streets and lots. This has discouraged development of flat buildings so much of the original housing stock from the Victorian, Edwardian, and inter-war periods remains relatively intact.

The streets retain much of their original bluestone detailing and some streets such as Raglan Street, Graylings Grove and Avenue and Godfrey Street, are flanked by mature Plane trees which enhance the character of these streets. Other streets with fewer trees derive their character from the diversity of architectural styles and the small scale of the streets and buildings.

The area is close to neighbourhood shopping centre, community facilities and transport and Alma Park provides substantial open space.

<i>Element</i>	<i>Description</i>
Dominant style	1900s - 1920s
Dominant scale	one storey
Dominant material	brick or masonry
Dominant roof	pitched/terracotta
Setback	less than 5 metres/minor variation
Heritage	@50% of area identified as heritage place
Gardens	visible/medium/small
Fences	medium height/various materials

The existing urban character of the City of Port Phillip has been assessed using 24 character elements. The design should especially respond to the important and very important elements, which in this area are:

<i>Element</i>	<i>Importance</i>
Building style	Very important
Building scale	Very important
Access	Very important
Lot size	Important
Pattern	Important
Setbacks	Important
Housing type	Important

A comprehensive urban character assessment and policy statement for the area is available from the Council .



City of Port Phillip
URBAN CHARACTER DESCRIPTION

AREA 29: LAND GENERALLY BOUNDED BY DANDENONG ROAD, CHAPEL STREET, ALMA ROAD AND WESTBURY STREET

The following description should be used in carrying out the site analysis and design response to your site. Pay attention to the very important and important character elements listed here, as well as the actual conditions observed at the site analysis stage.

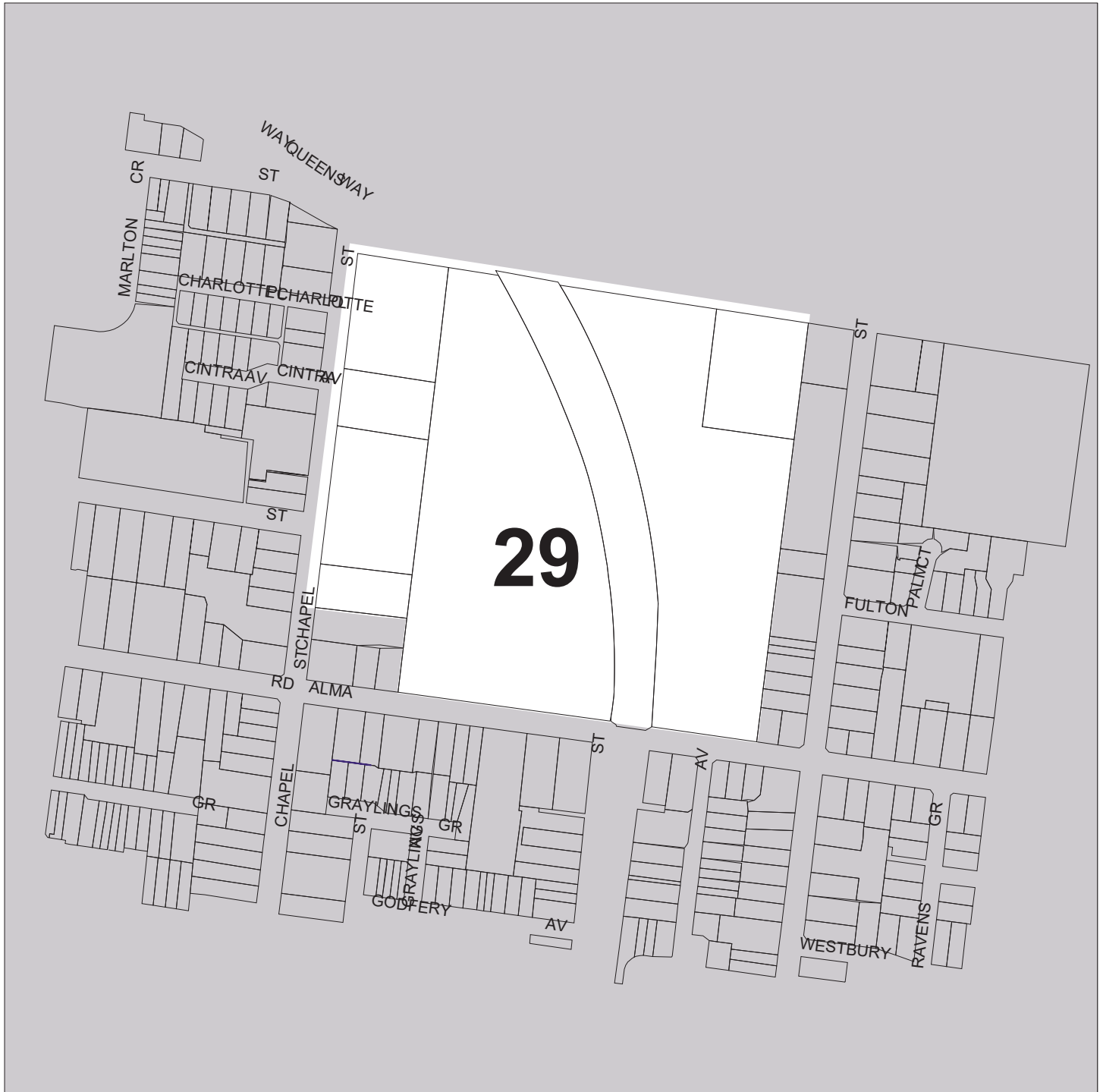

Boundary streets:

Dandenong Rd, Chapel St, Alma Rd, Westbury St.

Streets in the area:

Chapel St,

Description of the character of the area:

The area is distinguished from adjoining areas by the large size of the lot and the scale and set back of public buildings in a garden setting. Public buildings include churches, St Mary's school and the army depot

Whilst the Alma Road frontage is characterised by fine buildings, the gardens, front fences and streetscape are of poorer quality and tend to block views into the parkland.

Street trees in Dandenong Road contribute to the character of the area.

<i>Element</i>	<i>Description</i>
Dominant style	pre-1900s
Dominant scale	two storey
Dominant material	brick or masonry/mixed
Dominant roof	steeply pitched/slate
Setback	over 9 metres
Heritage	entire area identified as heritage place
Gardens	visible/large
Fences	none-medium/various materials

The existing urban character of the City of Port Phillip has been assessed using 24 character elements. The design should especially respond to the important and very important elements, which in this area are:

<i>Element</i>	<i>Importance</i>
Lot size	Very important
Heritage	Very important
Land use	Very important
Access	Very important
Open space	Very important
Front gardens	Important
Building style	Important

A comprehensive urban character assessment and policy statement for the area is available from the Council .



City of Port Phillip
URBAN CHARACTER DESCRIPTION

AREA 30: CHAPEL STREET BETWEEN ALMA ROAD AND CARLISLE STREET, ST KILDA

The following description should be used in carrying out the site analysis and design response to your site. Pay attention to the very important and important character elements listed here, as well as the actual conditions observed at the site analysis stage.

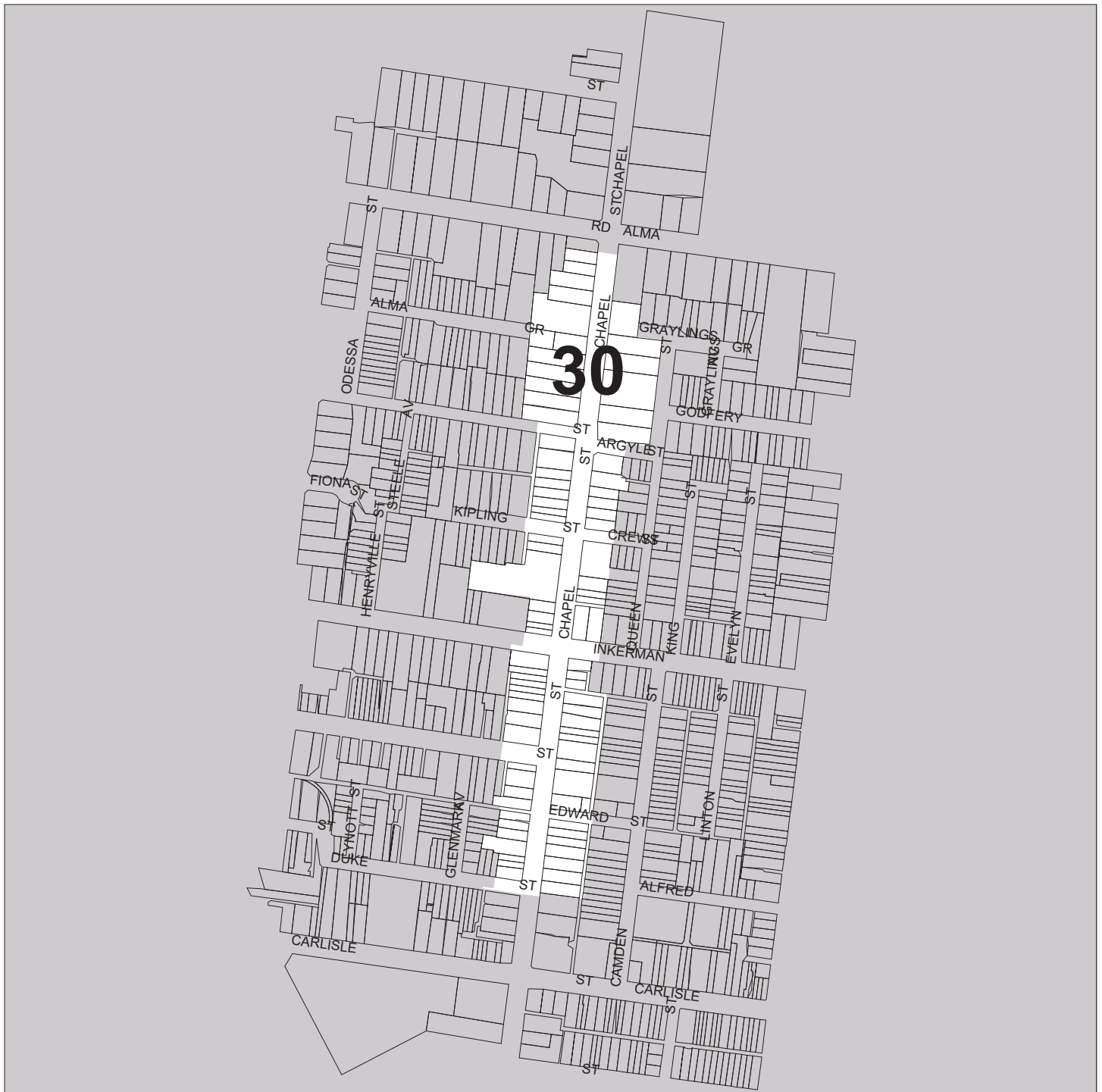

Boundary streets:

Chapel St, between Alma Rd and Carlisle St.

Streets in the area:

Argyle St, Chapel St, Crews St, Edward St,

Description of the character of the area:

The area has a wide variety of lot sizes and frontage widths which has precipitated substantial redevelopment since the Victorian period. This has created a streetscape of varied building styles and scales although flat blocks, particularly those built in the post-war period, are the most visually significant buildings. The diversity of building styles is also reflected in setbacks, front fences and front gardens.

Chapel Street has a wide reservation and wide pavement for carrying high volumes and traffic and also includes the central concreted tram strip. Footpaths and medians are quite narrow and the overhead services tend to be visually dominant. The street has recently been replanted with deciduous trees however some gum trees remain from an earlier planting.

The area has a good access especially to shops, public transport and public facilities.

<i>Element</i>	<i>Description</i>
Dominant style	1970s - 1990s
Dominant scale	one storey
Dominant material	brick or masonry/mixed
Dominant roof	pitched/terracotta
Setback	less than 5 metres/varied
Heritage	limited number of identified heritage places
Gardens	visible/small
Fences	various height and materials

The existing urban character of the City of Port Phillip has been assessed using 24 character elements. The design should especially respond to the important and very important elements, which in this area are:

<i>Element</i>	<i>Importance</i>
Traffic	Very important
Access	Very important
Street dimensions	Important
Overhead services	Important
Building scale	Important
Housing type	Important
Land use	Important

A comprehensive urban character assessment and policy statement for the area is available from the Council .



City of Port Phillip
URBAN CHARACTER DESCRIPTION

AREA 31: LAND GENERALLY BOUNDED BY DUKE STREET, PACKINGTON STREET, CHAPEL STREET AND LYNOTT STREET

The following description should be used in carrying out the site analysis and design response to your site. Pay attention to the very important and important character elements listed here, as well as the actual conditions observed at the site analysis stage.

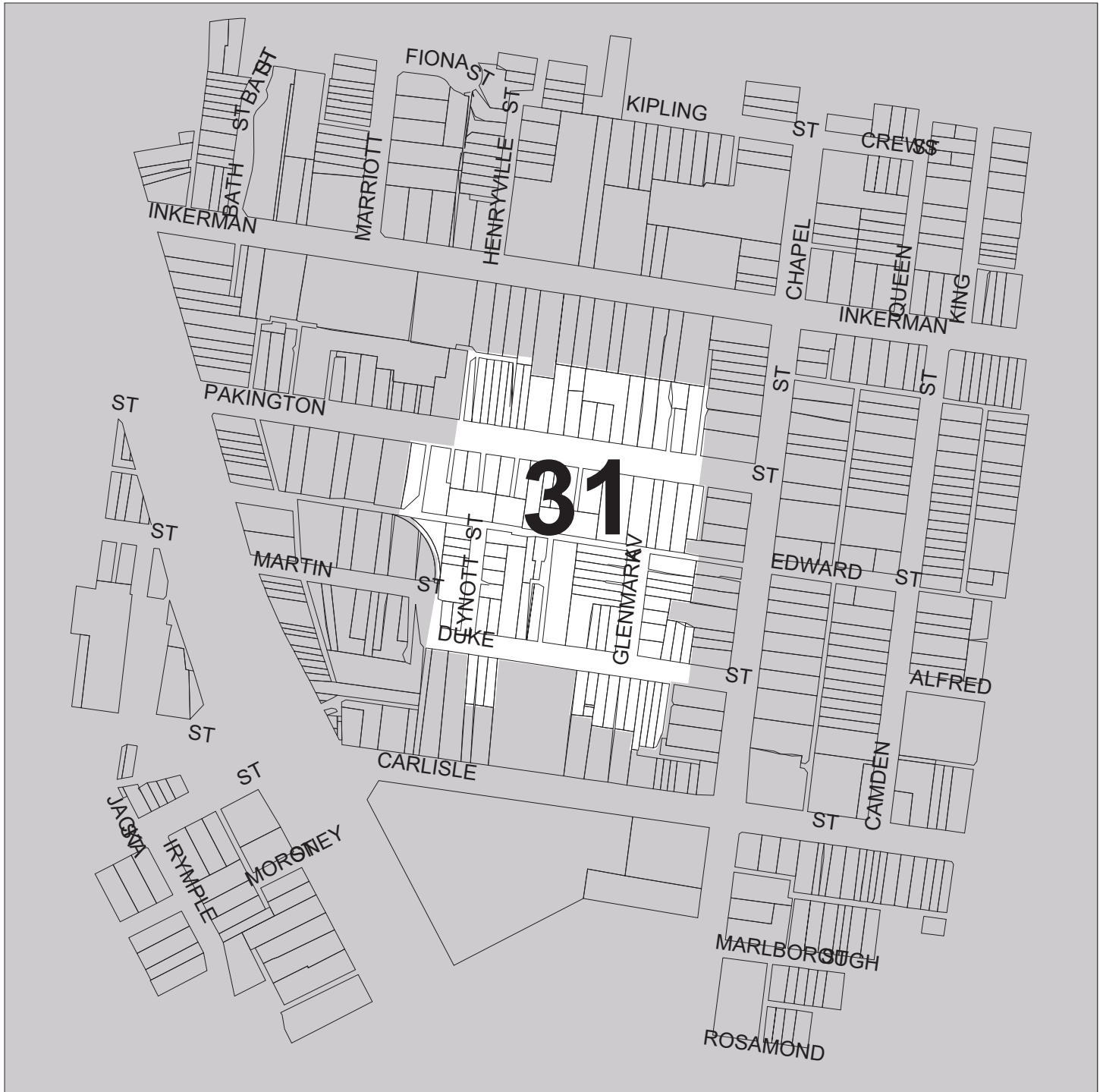

Boundary streets:

Duke St, Packington St, Chapel St, Lynott St.

Streets in the area:

Duke St, Glenmark Av, Lynott St, Pakington St,

Description of the character of the area:

This is a small area which has been largely developed with intact timber and brick workers' cottages from the Victorian and Edwardian periods except in Packington Street. Glenmark Avenue is a street of Edwardian duplex houses with excellent mature plane trees.

Although Packington Street includes some original houses, sections of the street have larger blocks which have been redeveloped with flats and houses during the 1960's and 1970's.

A bluestone drain bisects the area and is also an important heritage asset.

Some streets retain original bluestone detailing and a significant feature is a bluestone drain that bisects the area. Other streets, including Packington Street, have been reconstructed with concrete kerbs and channels.

The area has good access to shops services and transport and includes a small pocket park.

<i>Element</i>	<i>Description</i>
Dominant style	pre-1900s
Dominant scale	one storey
Dominant material	timber or cladding/varied
Dominant roof	pitched/metal
Setback	less than 5 metres/minor variation
Heritage	@90% identified heritage places
Gardens	visible/small
Fences	medium height/various materials

The existing urban character of the City of Port Phillip has been assessed using 24 character elements. The design should especially respond to the important and very important elements, which in this area are:

<i>Element</i>	<i>Importance</i>
Building style	Very important
Heritage	Very important
Access	Very important
Lot size	Important
Street dimensions	Important
Parking	Important
Setbacks	Important
Building scale	Important

A comprehensive urban character assessment and policy statement for the area is available from the Council .



City of Port Phillip
URBAN CHARACTER DESCRIPTION

AREA 32: LAND GENERALLY BOUNDED BY INKERMAN STREET, CHAPEL STREET, ST KILDA ROAD AND MARTIN STREET

The following description should be used in carrying out the site analysis and design response to your site. Pay attention to the very important and important character elements listed here, as well as the actual conditions observed at the site analysis stage.

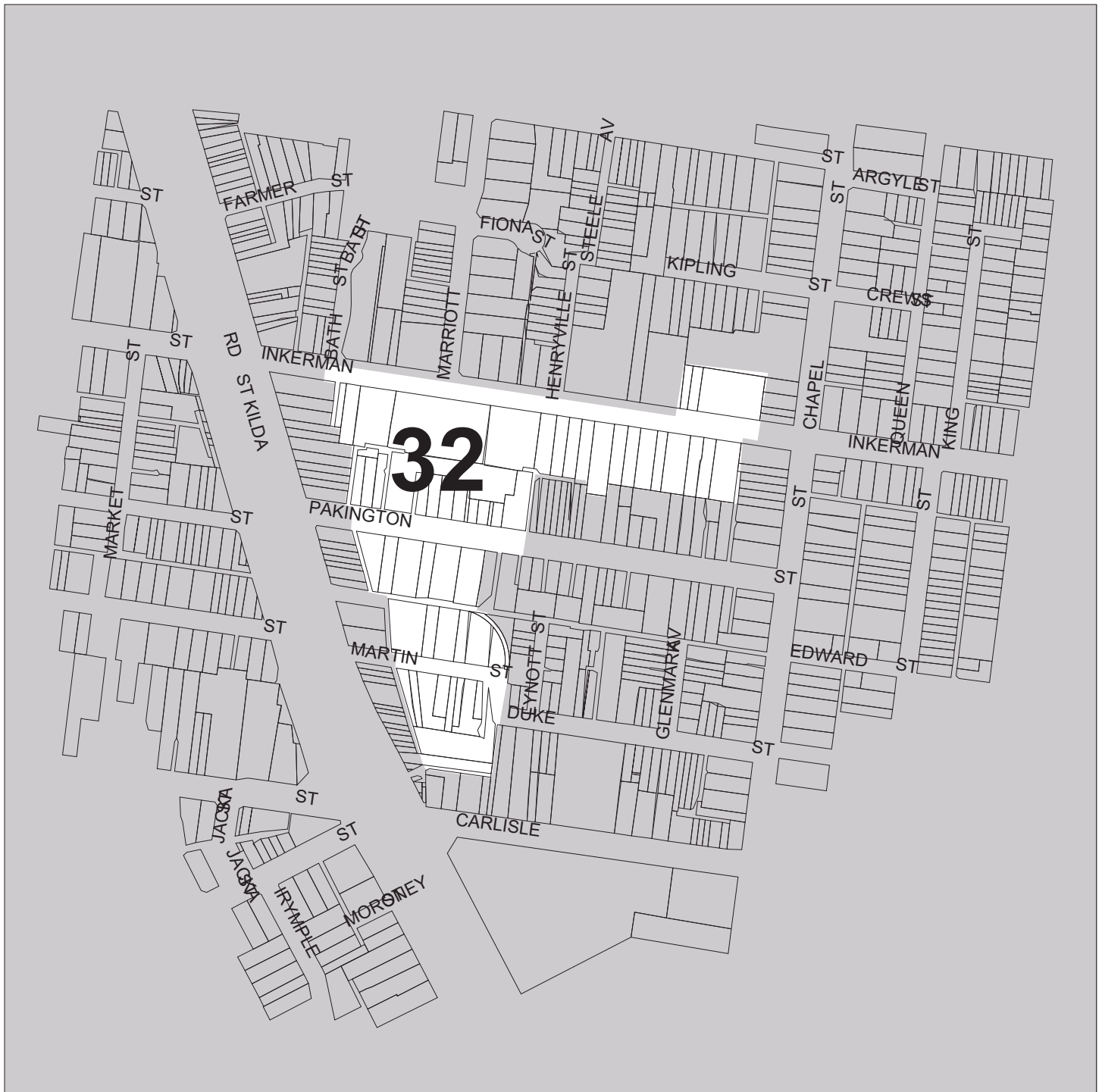

Boundary streets:

Inkerman St, Chapel St, St Kilda Rd, Martin St.

Streets in the area:

Inkerman St, Marlborough St,

Description of the character of the area:

This is a small area behind St Kilda Road distinguished from adjoining areas by its mixed land use and larger lot sizes. Industrial uses are concentrated in Martin and Packington Streets whilst properties fronting Inkerman Street have been developed as car outlets, offices and car parks together with original houses and flats.

Factory buildings in Packington and Martin Streets are generally poor design standard and on-site parking and crossings dominate the street frontage.

Streets lack significant street trees and signage of mixed quality has a significant presence.

The area is close to a neighbourhood shopping centre, community facilities and public transport.

<i>Element</i>	<i>Description</i>
Dominant style	1970s -1990s
Dominant scale	two storey
Dominant material	brick or masonry/mixed
Dominant roof	pitched/metal
Setback	less than 5 metres/minor variation
Heritage	virtually no identified heritage places
Gardens	visible/small
Fences	various height and materials

The existing urban character of the City of Port Phillip has been assessed using 24 character elements. The design should especially respond to the important and very important elements, which in this area are:

<i>Element</i>	<i>Importance</i>
Parking	Very important
Signage	Important
Setbacks	Important
Land use	Important
Access	Important

A comprehensive urban character assessment and policy statement for the area is available from the Council .



City of Port Phillip
URBAN CHARACTER DESCRIPTION

AREA 33: LAND GENERALLY BOUND BY INKERMAN STREET, BATH STREET, ARGYLE STREET AND KIPLING STREET

The following description should be used in carrying out the site analysis and design response to your site. Pay attention to the very important and important character elements listed here, as well as the actual conditions observed at the site analysis stage.

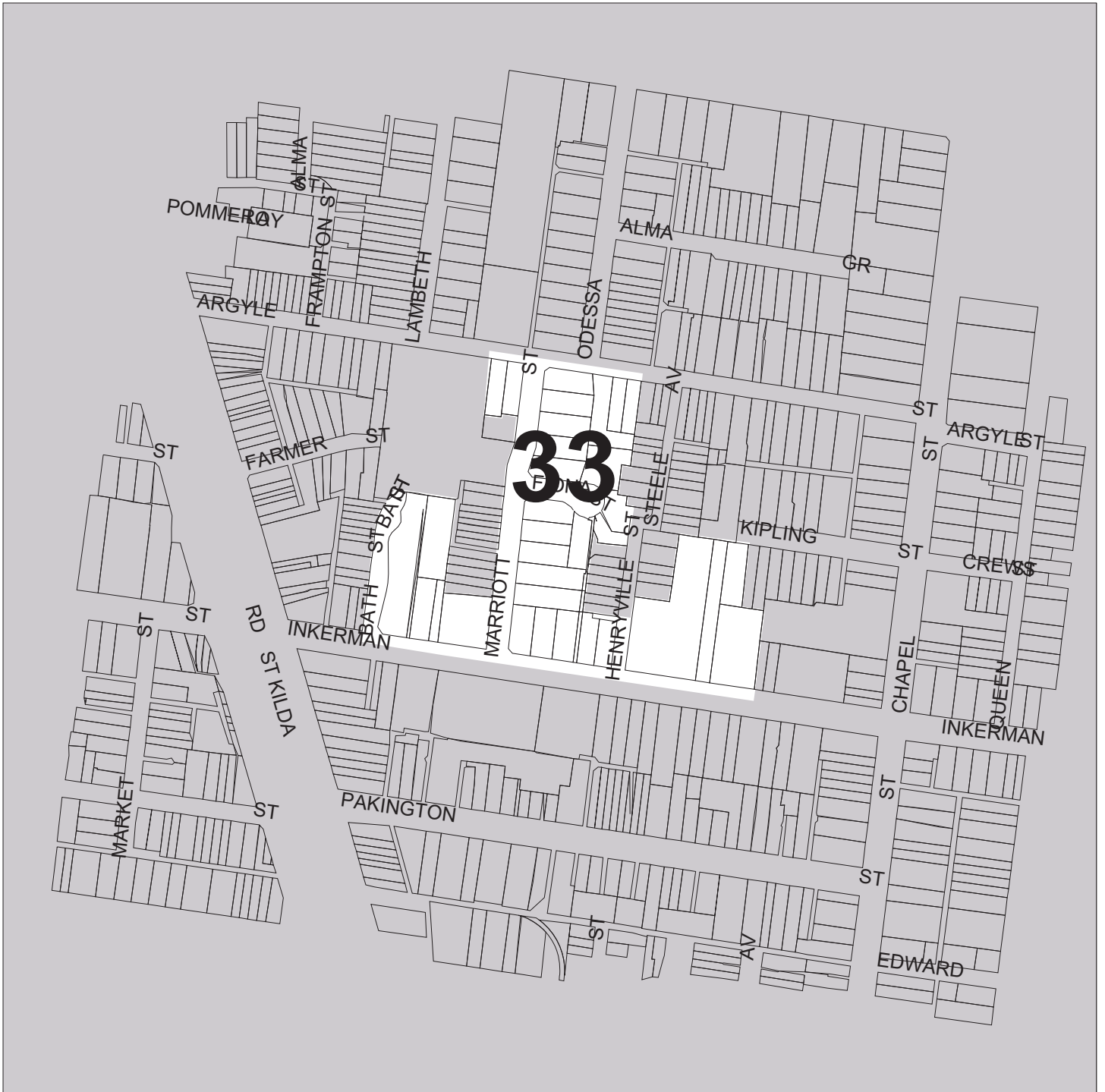

Inkerman St, Bath St, Argyle St, Kipling St.

Streets in the area:

Bath St, Fiona Ct, Inkerman St, Marriott St,

Description of the character of the area:

The area is predominantly medium and larger sized lots which have been redeveloped in the post-war period with a mixture of public and private flat developments. The public housing includes walk up blocks and a thirteen storey high rise block set in landscaped surrounds. The balance of the area consists of a number of mostly three storey cream brick flat blocks with small setbacks for off-street car parking.

The high rise building has extensive communal landscaped areas contrasting with private flat developments which have minimal landscaping.

Some original blue stone kerbs and channels remain from an earlier period. Street trees have little impact and parked cars are visually dominant.

<i>Element</i>	<i>Description</i>
Dominant style	1970s - 1990s
Dominant scale	three storey
Dominant material	brick or masonry
Dominant roof	pitched/terracotta
Setback	less than 5 metres/consistent
Heritage	virtually no identified heritage places
Gardens	visible/large/small
Fences	low-medium/various materials

The existing urban character of the City of Port Phillip has been assessed using 24 character elements. The design should especially respond to the important and very important elements, which in this area are:

<i>Element</i>	<i>Importance</i>
Building scale	Very important
Housing type	Very important
Lot size	Important
Parking	Important
Setbacks	Important
Building style	Important
Access	Important

A comprehensive urban character assessment and policy statement for the area is available from the Council .



City of Port Phillip
URBAN CHARACTER DESCRIPTION

AREA 34: ST KILDA ROAD BETWEEN CARLISLE STREET AND FITZROY STREET, ST KILDA

The following description should be used in carrying out the site analysis and design response to your site. Pay attention to the very important and important character elements listed here, as well as the actual conditions observed at the site analysis stage.

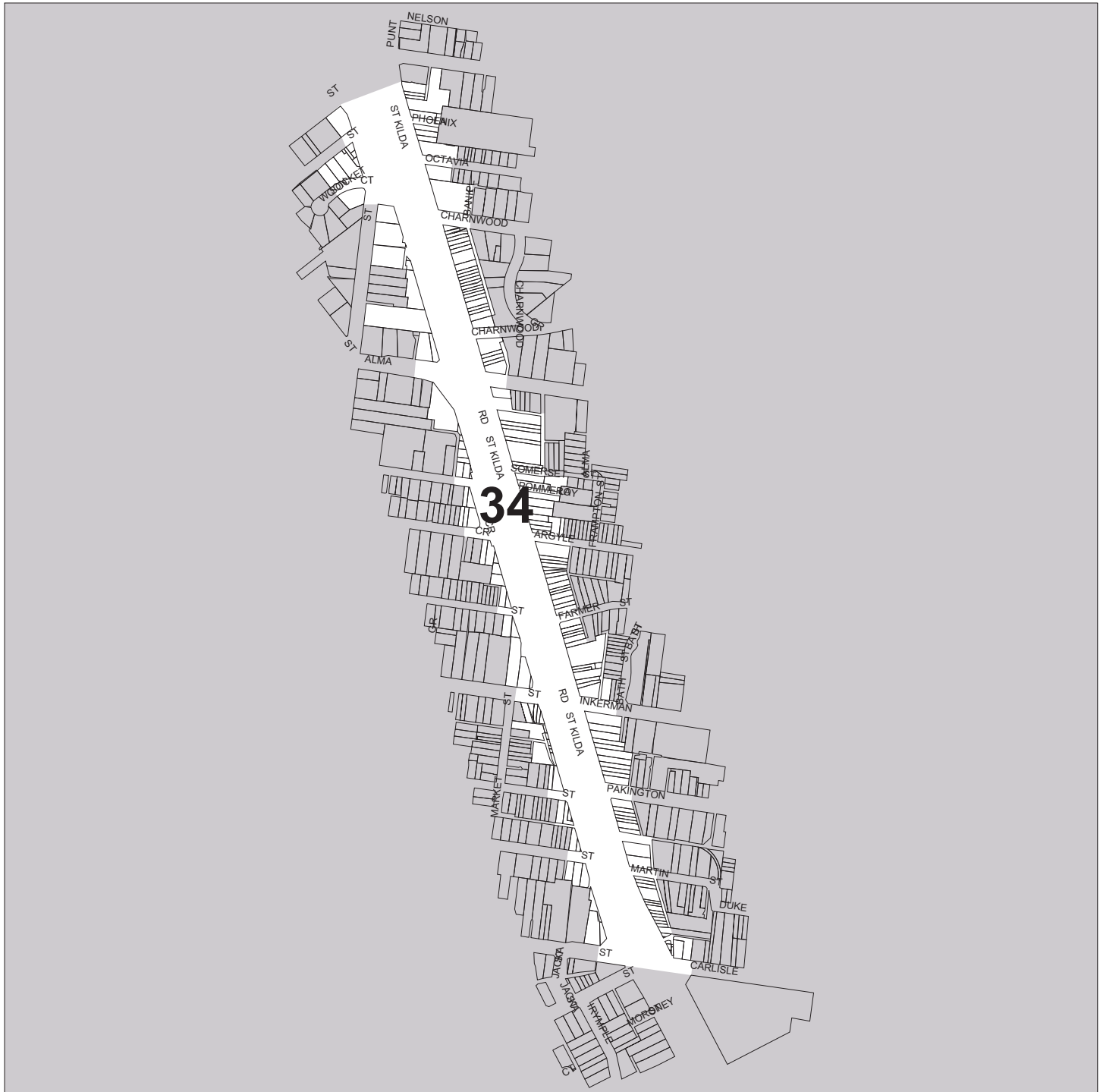

Boundary streets:

St Kilda Rd between Carlisle St and Fitzroy St.

Streets in the area:

Barkly St, Market St, Phoenix La, Pummeroy St, St Kilda Rd, St Kilda Rd, Woonsocket Ct,

Description of the character of the area:

The road was originally a typical strip shopping centre but Victorian commercial buildings were removed on the western side to create four traffic lanes in each direction, parking lanes and a wide median strip incorporating the tram line. The dominant characteristics of this new reservation are a wide street profile, two distinctly different edges, heavy traffic and the median with its semi-mature spotted gums.

The original development on the eastern side is mostly terraced shops and other commercial buildings, mostly dating from the Victorian period. Unfortunately, the heritage qualities of buildings along this edge have been undermined by poor renovation and uncontrolled signage.

The area sits between two neighbourhood shopping centres and has good tram access.

<i>Element</i>	<i>Description</i>
Dominant style	pre-1900s
Dominant scale	two storey
Dominant material	stucco and render/minor variation
Dominant roof	pitched/concealed by parapets
Setback	less than 5 metres/varied
Heritage	limited number of heritage places
Gardens	none
Fences	none

The existing urban character of the City of Port Phillip has been assessed using 24 character elements. The design should especially respond to the important and very important elements, which in this area are:

<i>Element</i>	<i>Importance</i>
Street dimensions	Very important
Traffic	Very important
Landform	Important
Street trees	Important
Signage	Important
Land use	Important
Access	Important

A comprehensive urban character assessment and policy statement for the area is available from the Council .



City of Port Phillip
URBAN CHARACTER DESCRIPTION

AREA 35: LAND GENERALLY BOUNDED BY ALMA ROAD, CHAPEL STREET, INKERMAN STREET AND ST KILDA ROAD

The following description should be used in carrying out the site analysis and design response to your site. Pay attention to the very important and important character elements listed here, as well as the actual conditions observed at the site analysis stage.

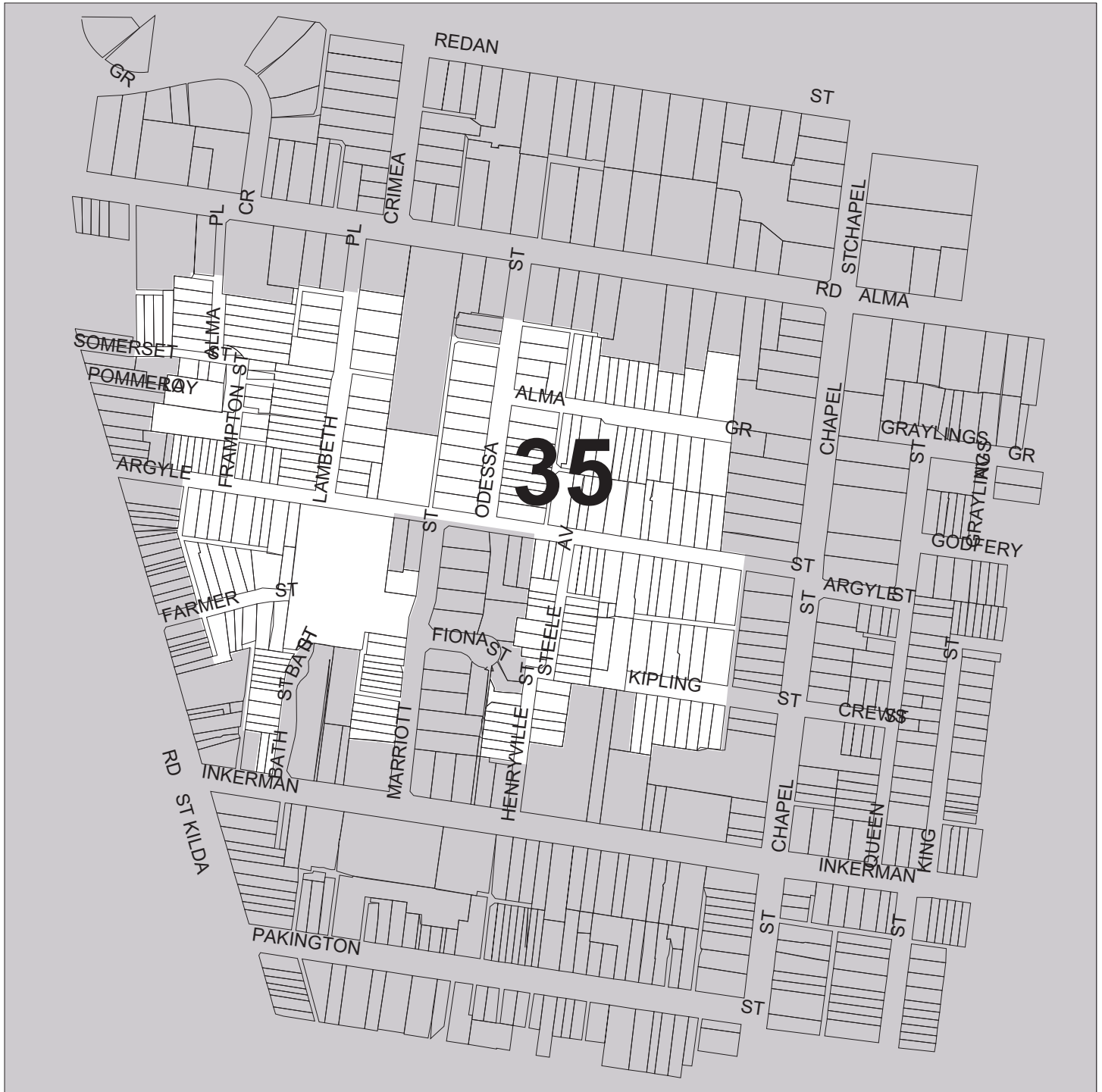

Boundary streets:

Alma Rd, St Kilda Rd, Chapel St, Inkerman St.

Streets in the area:

Alma Gv, Argyle St, Farmer St, Frampton St, Henryville St, Kipling St, Lambeth Pl, Odessa St, Somerset St, Steele Av,

Description of the character of the area:

The area is a complex, small scale subdivision with many medium and narrow streets and lanes. The lot size is typically small and duplex houses are common. Housing has been primarily developed during the Edwardian period although there are examples of Victorian and inter-war housing styles.

There has been limited redevelopment in the form of public housing and a limited number of private flat developments, so the area retains its small single storey scale.

Most streets retain original bluestone and bitumen detailing. Smaller native trees planted in the past few decades do not contribute greatly to the area.

The area is somewhat distant from a neighbourhood shopping centre and is densely settled.

<i>Element</i>	<i>Description</i>
Dominant style	1900s - 1920s
Dominant scale	one storey
Dominant material	brick or masonry/mixed
Dominant roof	pitched/terracotta
Setback	less than 5 metres/minor variation
Heritage	limited number of identified heritage places
Gardens	visible/medium/small
Fences	low-medium/various materials

The existing urban character of the City of Port Phillip has been assessed using 24 character elements. The design should especially respond to the important and very important elements, which in this area are:

<i>Element</i>	<i>Importance</i>
Building scale	Very important
Parking	Important
Street detailing	Important
Fences	Important
Setbacks	Important
Front gardens	Important
Building style	Important
Housing type	Important
Heritage	Important
Access	Important

A comprehensive urban character assessment and policy statement for the area is available from the Council .



City of Port Phillip
URBAN CHARACTER DESCRIPTION

AREA 36: LAND GENERALLY BOUNDED BY WELLINGTON STREET, CHAPEL STREET, ST KILDA ROAD AND ALMA ROAD

The following description should be used in carrying out the site analysis and design response to your site. Pay attention to the very important and important character elements listed here, as well as the actual conditions observed at the site analysis stage.

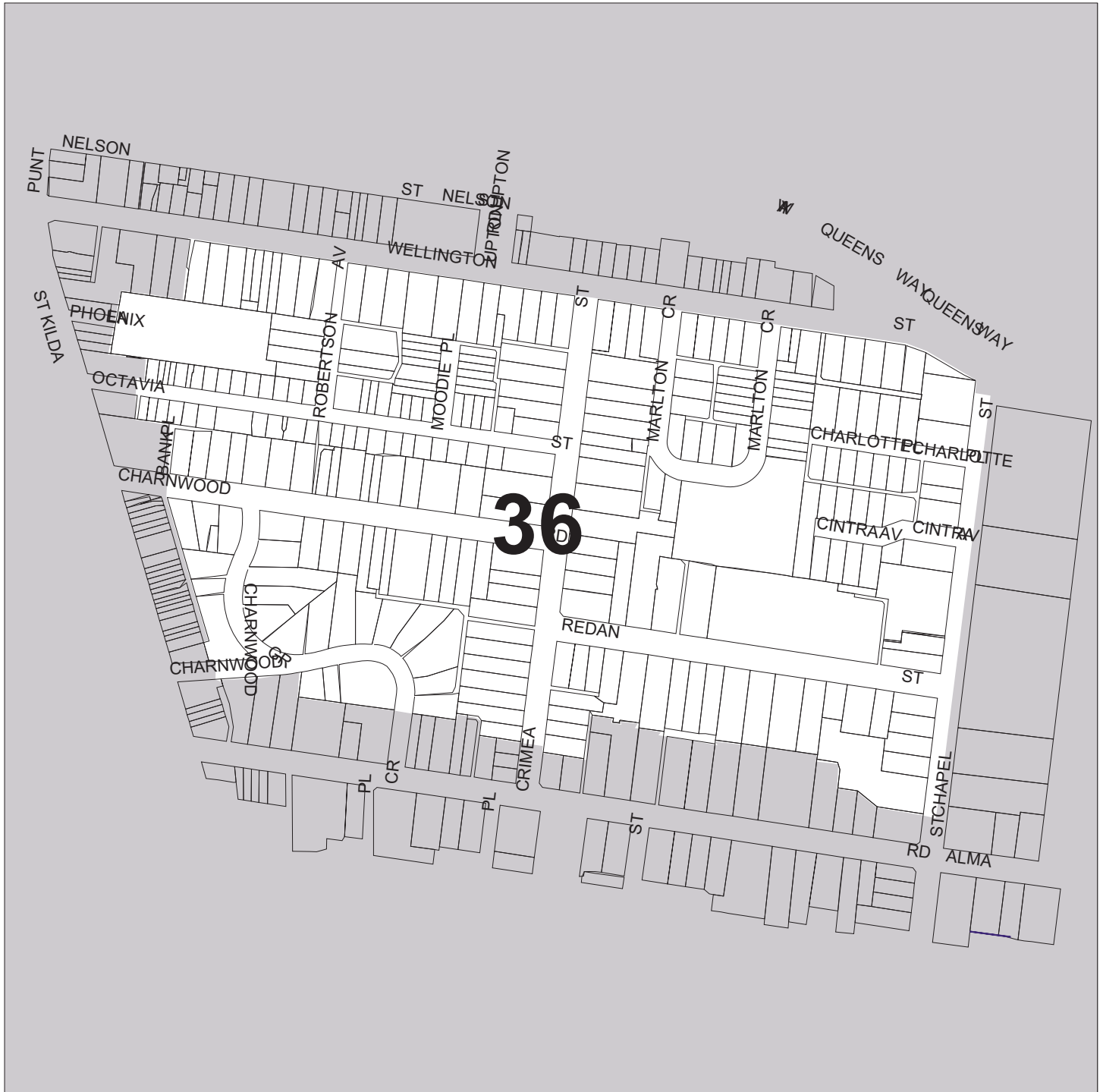

Boundary streets:

Wellington St, St Kilda Rd, Chapel St, Alma Rd.

Streets in the area:

Bank Pl, Charlotte Pl, Charnwood Cr, Charnwood Gv, Charnwood Rd, Cintra Av, Crimea St, Marlton Cr, Moodie Pl, Octavia St, Redan St, Robertson Av,

Description of the character of the area:

The area has a pattern of wide and narrow streets including some cul-de-sacs and curvilinear streets. Lot sizes vary but are predominantly quite large.

The area has been developed almost continuously from the Victorian period and many large houses from this period sit with large flat buildings from the inter and post-war period. St Michael's Grammar is a major non-residential land use in the area however it is reasonably well integrated in its urban design character

Most of the streets in this area are lined with mature Plane trees which are very important to the area's cohesiveness and character.

<i>Element</i>	<i>Description</i>
Dominant style	pre-1900s
Dominant scale	one, two and three stories
Dominant material	stucco and render/mixed
Dominant roof	pitched/metal
Setback	less than 5 metres/minor variation
Heritage	more than 75% identified as heritage place
Gardens	visible/medium
Fences	low-medium/various materials

The existing urban character of the City of Port Phillip has been assessed using 24 character elements. The design should especially respond to the important and very important elements, which in this area are:

<i>Element</i>	<i>Importance</i>
Street trees	Very important
Building style	Very important
Heritage	Very important
Landform	Important
Lot size	Important
Parking	Important
Building scale	Important
Housing type	Important
Access	Important

A comprehensive urban character assessment and policy statement for the area is available from the Council .



City of Port Phillip
URBAN CHARACTER DESCRIPTION

AREA 37: LAND GENERALLY BOUNDED BY ST KILDA ROAD, CARLISLE STREET AND BARKLY STREET

The following description should be used in carrying out the site analysis and design response to your site. Pay attention to the very important and important character elements listed here, as well as the actual conditions observed at the site analysis stage.



Boundary streets:

St Kilda Rd, Alma Rd, Barkley St, Inkerman St.

Streets in the area:

Barkly St, Blanche St, Charles St, Greeves St, Inkerman Gv, Inkerman St, Lyell St, St Kilda Rd, Vale St, Waterloo Cr,

Description of the character of the area:

Streets mostly run east-west and are quite varied in their dimensions. Lot sizes are also extremely varied.

The area has been developed with modest artisan housing from the Victorian and Edwardian periods although there has been considerable development of larger sites for multi unit development during the post-war periods. Housing close to St Kilda Road that is intermingled with light industry appears to be relatively run down.

The commercial and light industrial uses along Inkerman Street and further south together with residential use is perhaps the area's most outstanding characteristic.

Streets still retain most of their original details and street trees are generally inconsistent with smaller scale natives that do not contribute to the area's character.

<i>Element</i>	<i>Description</i>
Dominant style	pre-1900s
Dominant scale	one storey
Dominant material	brick or masonry/mixed
Dominant roof	pitched/metal
Setback	less than 5 metres/minor variation
Heritage	limited number of identified heritage places
Gardens	visible/medium
Fences	medium height/various materials

The existing urban character of the City of Port Phillip has been assessed using 24 character elements. The design should especially respond to the important and very important elements, which in this area are:

<i>Element</i>	<i>Importance</i>
Land use	Very important
Setbacks	Important
Building scale	Important
Access	Important

A comprehensive urban character assessment and policy statement for the area is available from the Council .



City of Port Phillip
URBAN CHARACTER DESCRIPTION

AREA 38: LAND IN VICINITY OF ACLAND STREET, CARLISLE STREET AND BARKLY STREET

The following description should be used in carrying out the site analysis and design response to your site. Pay attention to the very important and important character elements listed here, as well as the actual conditions observed at the site analysis stage.

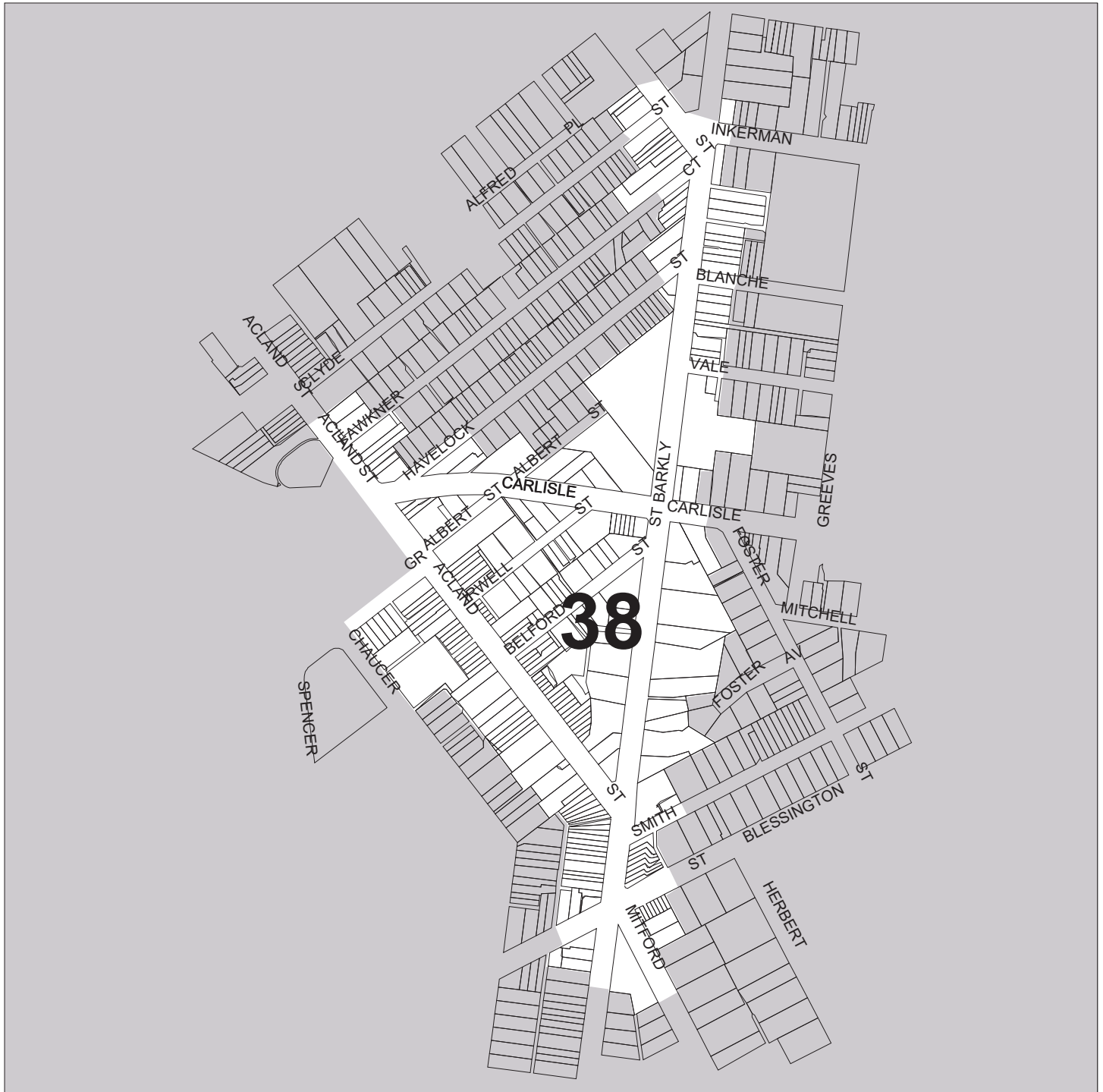

Boundary streets:

Barkly St between Blessington St and Inkerman St, Acland St, Carlisle St.

Streets in the area:

Acland St, Albert St, Barkly St, Belford St, Blanche St, Carlisle St, Foster St, Irwell St,

Description of the character of the area:

The area is distinguished from adjoining areas by its primary commercial land use.

The Acland Street shopping centre, or 'Village Belle' is both a local shopping centre and significant tourist attraction. In addition, the area contains a significant number of houses, flat blocks and some shop-top accommodation.

Barkly Street and Carlisle Street both carry heavy through traffic and support a mix of intermingled housing and commercial uses.

Acland Street is the intensive shopping and restaurant area with a new semi-pedestrian street design. Smaller streets between Acland and Barkly street accommodate mostly houses, flats and car parks serving the shopping centre.

The area is extremely accessible to shops and services and is served by trams in Acland and Carlisle Streets.

<i>Element</i>	<i>Description</i>
Dominant style	1920s - 1940s
Dominant scale	two storey
Dominant material	stucco and render/minor variation
Dominant roof	concealed by parapets/metal
Setback	less than 5 metres/consistent
Heritage	limited number of identified heritage places
Gardens	visible/small
Fences	buildings to property line

The existing urban character of the City of Port Phillip has been assessed using 24 character elements. The design should especially respond to the important and very important elements, which in this area are:

<i>Element</i>	<i>Importance</i>
Traffic	Very important
Parking	Very important
Setbacks	Very important
Building scale	Very important
Land use	Very important
Access	Very important
Overhead services	Important
Signage	Important
Open space	Important
Foreshore	Important

A comprehensive urban character assessment and policy statement for the area is available from the Council .



City of Port Phillip
URBAN CHARACTER DESCRIPTION

**AREA 39: BARKLEY AND GREY STREETS BETWEEN PATTISON STREET, FITZROY STREET
AND INKERMAN STREET**

The following description should be used in carrying out the site analysis and design response to your site. Pay attention to the very important and important character elements listed here, as well as the actual conditions observed at the site analysis stage.



Boundary streets:

Barkly St between Patterson St and Inkerman St, Grey St between Barkly St and Jackson St.

Streets in the area:

Alma Rd, Barkly St, Grey St, St Kilda Rd,

Description of the character of the area:

This area is distinct from adjoining areas because it follows large scale arterial roads and is lined with larger scale development. The hilltop at the junction of Barkly Street and Princess Street is a significant landmark in the area.

The combination of land form and busy wide streets also creates some significant long views to the north and the south.

The area was originally developed with large houses in the Victorian period and has subsequently undergone two phases of development with the addition of three storey walk-up flat blocks during the inter war period and more recently the post war period.

<i>Element</i>	<i>Description</i>
Dominant style	1920s - 1940s
Dominant scale	two and three storey
Dominant material	stucco and render/mixed
Dominant roof	pitched/terracotta
Setback	less than 5 metres/consistent
Heritage	@90% identified as heritage place
Gardens	visible/small
Fences	medium height/various materials

The existing urban character of the City of Port Phillip has been assessed using 24 character elements. The design should especially respond to the important and very important elements, which in this area are:

<i>Element</i>	<i>Importance</i>
Landform	Very important
Traffic	Very important
Building scale	Very important
Housing type	Very important
Heritage	Very important
Views	Important
Lot size	Important
Street dimensions	Important
Fences	Important
Setbacks	Important
Building style	Important
Access	Important

A comprehensive urban character assessment and policy statement for the area is available from the Council .



City of Port Phillip
URBAN CHARACTER DESCRIPTION

AREA 40: CLYDE STREET, FAWKNER CRESCENT AND HAVELOCK STREET

The following description should be used in carrying out the site analysis and design response to your site. Pay attention to the very important and important character elements listed here, as well as the actual conditions observed at the site analysis stage.

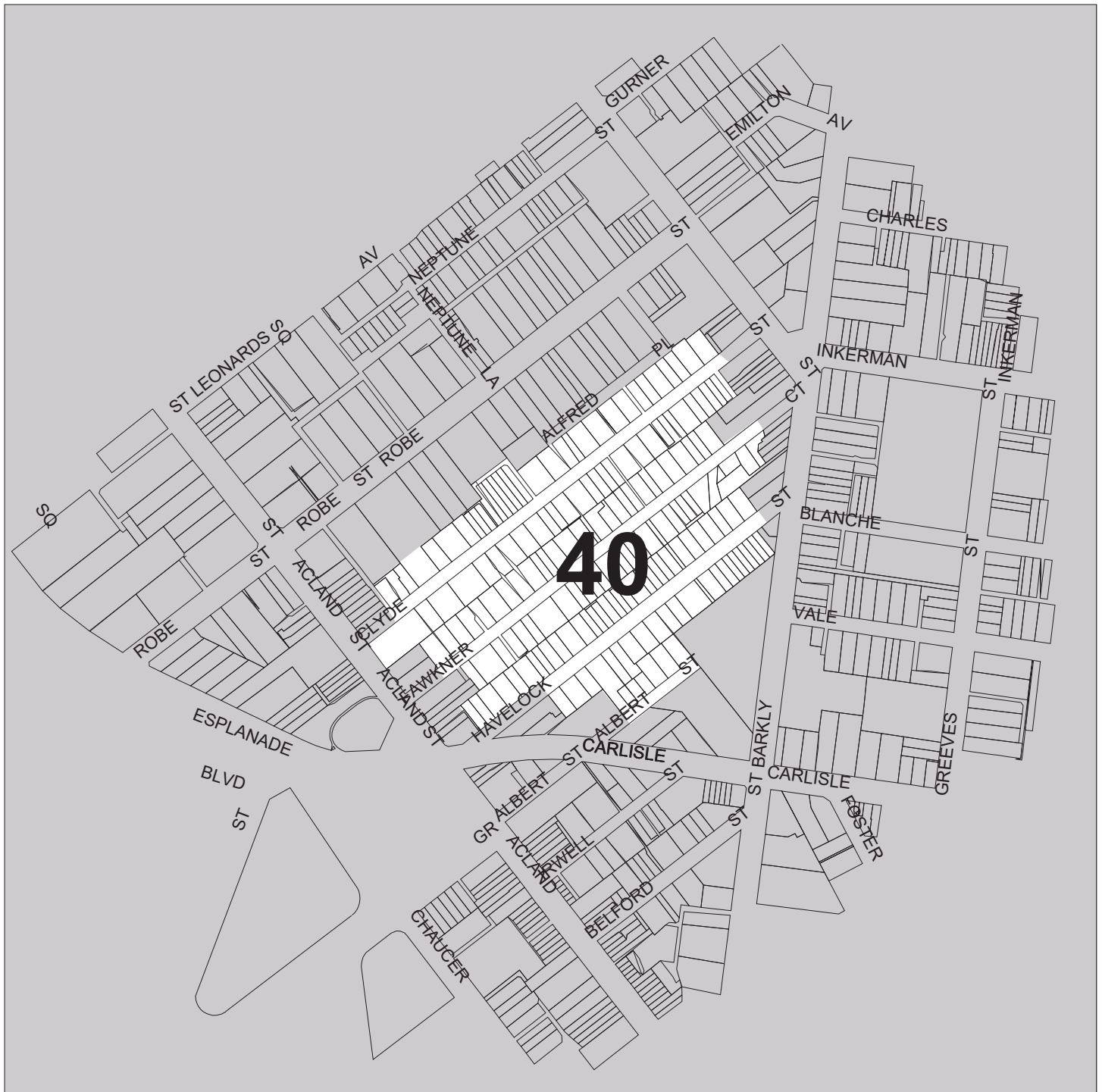

Boundary streets:

Acland Street, Barkly Street, Albert Street, Clyde Street.

Streets in the area:**Description of the character of the area:**

The area was initially developed as workers cottages during the Victorian period, although many buildings also date from the inter-war and Edwardian periods. Limited replacement of houses has also occurred in the post war period.

It derives its character from the small scale single storey housing which together with consistent small setbacks and narrow streets, provides an intimate urban scale.

The streets still retain their original detailing but some have been modified to become one way. Speed humps and a limited number of street trees are another recent addition.

Car parking appears to be at a premium in this area and visually dominates the streetscape. Front fences and front gardens are also important.

The area has excellent access to shops and public transport.

<i>Element</i>	<i>Description</i>
Dominant style	pre-1900s
Dominant scale	one storey
Dominant material	stucco and render/mixed
Dominant roof	pitched/metal
Setback	less than 5 metres/consistent
Heritage	entire area identified as heritage place
Gardens	visible/small
Fences	medium height/various materials

The existing urban character of the City of Port Phillip has been assessed using 24 character elements. The design should especially respond to the important and very important elements, which in this area are:

<i>Element</i>	<i>Importance</i>
Building scale	Very important
Access	Very important
Street dimensions	Important
Traffic	Important
Street detailing	Important
Fences	Important
Setbacks	Important
Building style	Important
Housing type	Important

A comprehensive urban character assessment and policy statement for the area is available from the Council .



City of Port Phillip
URBAN CHARACTER DESCRIPTION

AREA 41: LAND GENERALLY IN THE VICINITY OF LITTLE GREY STREET, DALGETY STREET, BURNETT STREET AND GURNER STREET

The following description should be used in carrying out the site analysis and design response to your site. Pay attention to the very important and important character elements listed here, as well as the actual conditions observed at the site analysis stage.

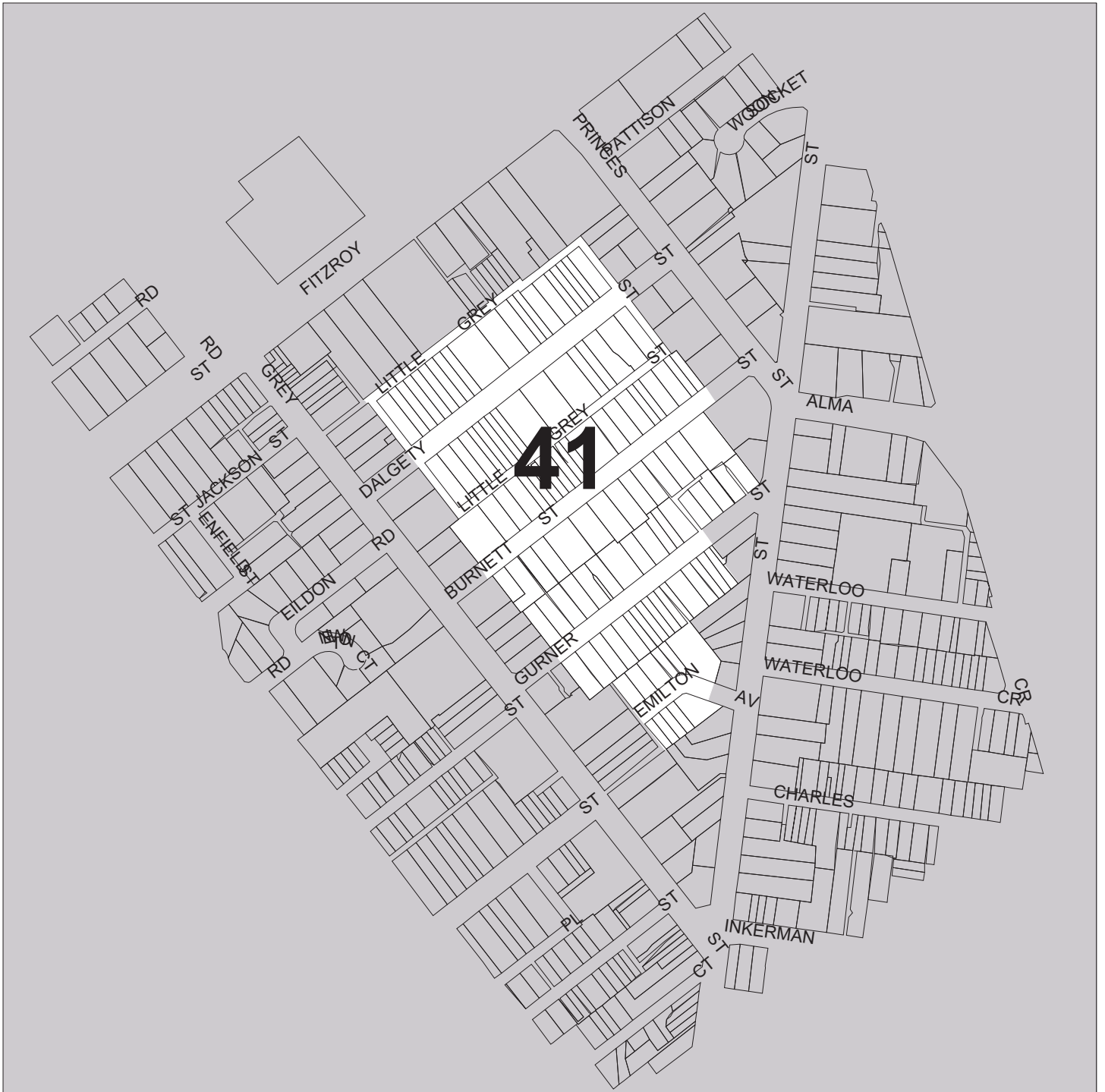

Boundary streets:

Emilton Street, Little Grey Street, Grey Street, Barkly Street.

Streets in the area:

Burnett St, Dalgety La, Dalgety St, Emilton Av, Gurner St, Little Grey St,

Description of the character of the area:

The area consists of a series of medium sized parallel streets running between Princess and Grey Streets. Little Grey Street and Dalgety Lane have an unusual formal lane layout with a wide range of lot sizes and frontages.

The original phase of development consisted of large Victorian homes and terraces, however the area has been further subdivided and developed during the Edwardian and inter-war period, especially in Dalgety Street.

Streets substantially maintain their original detailing, however street trees and other street landscaping is less than successful and tends to detract from the character of the area.

The area is close to Fitzroy Street shops, Albert Park and is well served by public transport.

<i>Element</i>	<i>Description</i>
Dominant style	pre-1900s
Dominant scale	one, two and three storey
Dominant material	brick or masonry/mixed
Dominant roof	pitched/metal
Setback	less than 5 metres/minor variation
Heritage	entire area identified as heritage place
Gardens	visible/large/medium/small
Fences	low-medium/various materials

The existing urban character of the City of Port Phillip has been assessed using 24 character elements. The design should especially respond to the important and very important elements, which in this area are:

<i>Element</i>	<i>Importance</i>
Heritage	Very important
Access	Very important
Front gardens	Important
Building style	Important

A comprehensive urban character assessment and policy statement for the area is available from the Council .



City of Port Phillip
URBAN CHARACTER DESCRIPTION

AREA 42: LAND GENERALLY BOUNDED BY FITZROY STREET, GREY STREET, CLYDE STREET AND ACLAND STREET, ST KILDA

The following description should be used in carrying out the site analysis and design response to your site. Pay attention to the very important and important character elements listed here, as well as the actual conditions observed at the site analysis stage.

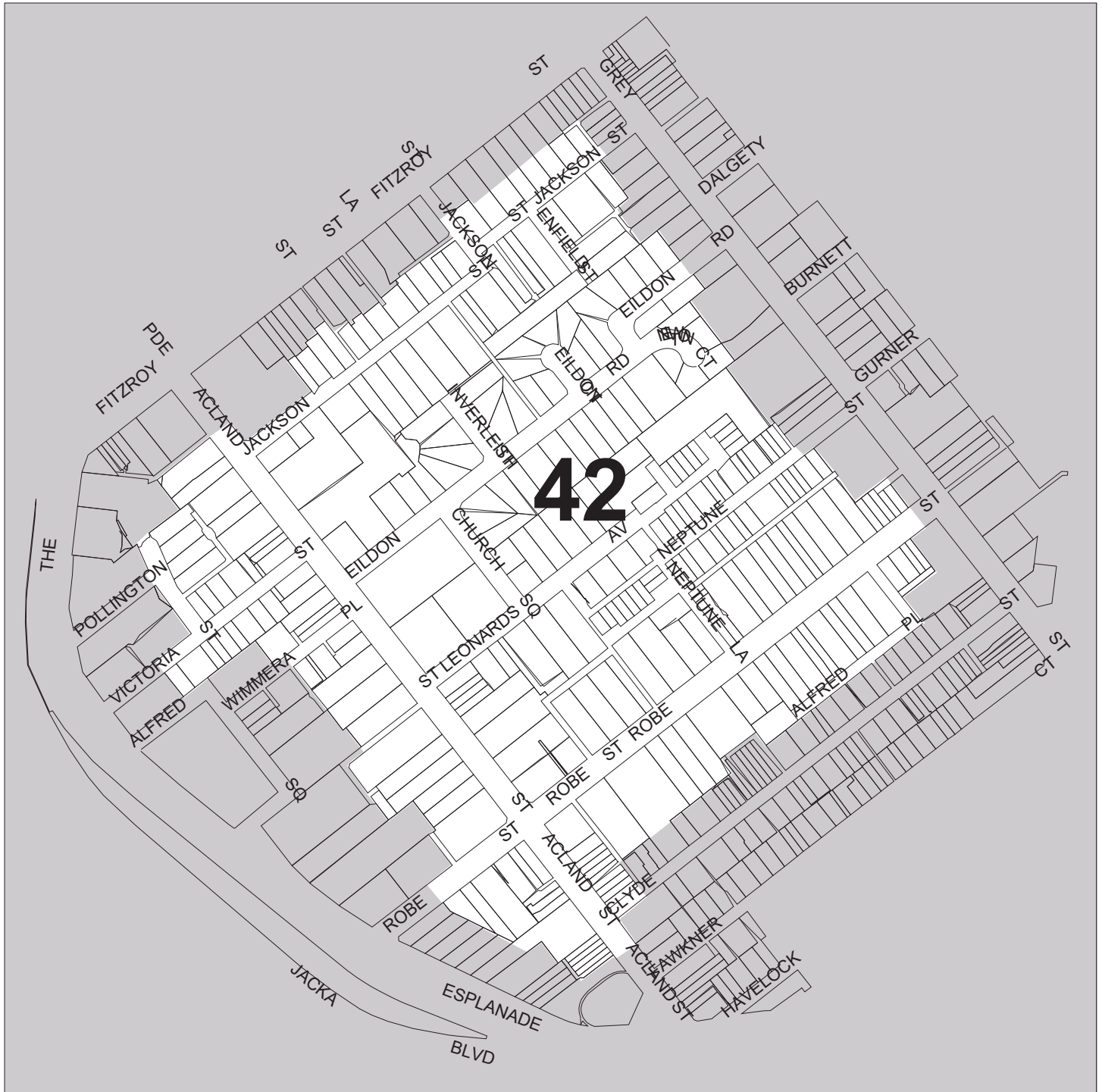

Boundary streets:

Grey Street, Jackson Street, Alfred Street, Pollington Street.

Streets in the area:

Acland St, Alfred Pl, Church Sq, Eildon Ct, Eildon Rd, Enfield St, Grey St, Inverleith Ct, Jackson St, Neptune La, Neptune St, Newton Ct, Pollington St, Robe St, St Leonards Av, Victoria St, Wimmera Pl,

Description of the character of the area:

The area was originally subdivided Victorian mansions and has undergone subsequent periods of development in the inter-war and post-war periods with a wide variety of apartment buildings.

Buildings tend to be large in scale although there is a variety of lot sizes, frontages and housing types. High quality buildings from different eras making the area architecturally rich and diverse.

Streets in the area are also mixed in their dimensions and detailing, reflecting different periods of subdivision.

The area is no longer permeable by car due to the addition of numerous traffic control devices and system of one way streets.

Front gardens and front fences are important to the character of the area. Apart from Acland Street, street trees in the area are patchy and of limited value to the area.

The area is within walking distance of Acland Street and Fitzroy Street shopping areas and is also well located in relation to public transport and the foreshore.

<i>Element</i>	<i>Description</i>
Dominant style	pre-1900s
Dominant scale	one and two storey
Dominant material	brick or masonry/mixed
Dominant roof	pitched/terracotta
Setback	less than 5 metres/minor variation
Heritage	entire area identified as heritage place
Gardens	visible/medium/small
Fences	low-medium/various materials

The existing urban character of the City of Port Phillip has been assessed using 24 character elements. The design should especially respond to the important and very important elements, which in this area are:

<i>Element</i>	<i>Importance</i>
Building style	Very important
Building scale	Very important
Housing type	Very important
Heritage	Very important
Access	Very important
Setbacks	Important
Front gardens	Important
Land use	Important

A comprehensive urban character assessment and policy statement for the area is available from the Council .



City of Port Phillip
URBAN CHARACTER DESCRIPTION

AREA 43: THE ESPLANADE BETWEEN FITZROY STREET AND ACLAND STREET

The following description should be used in carrying out the site analysis and design response to your site. Pay attention to the very important and important character elements listed here, as well as the actual conditions observed at the site analysis stage.

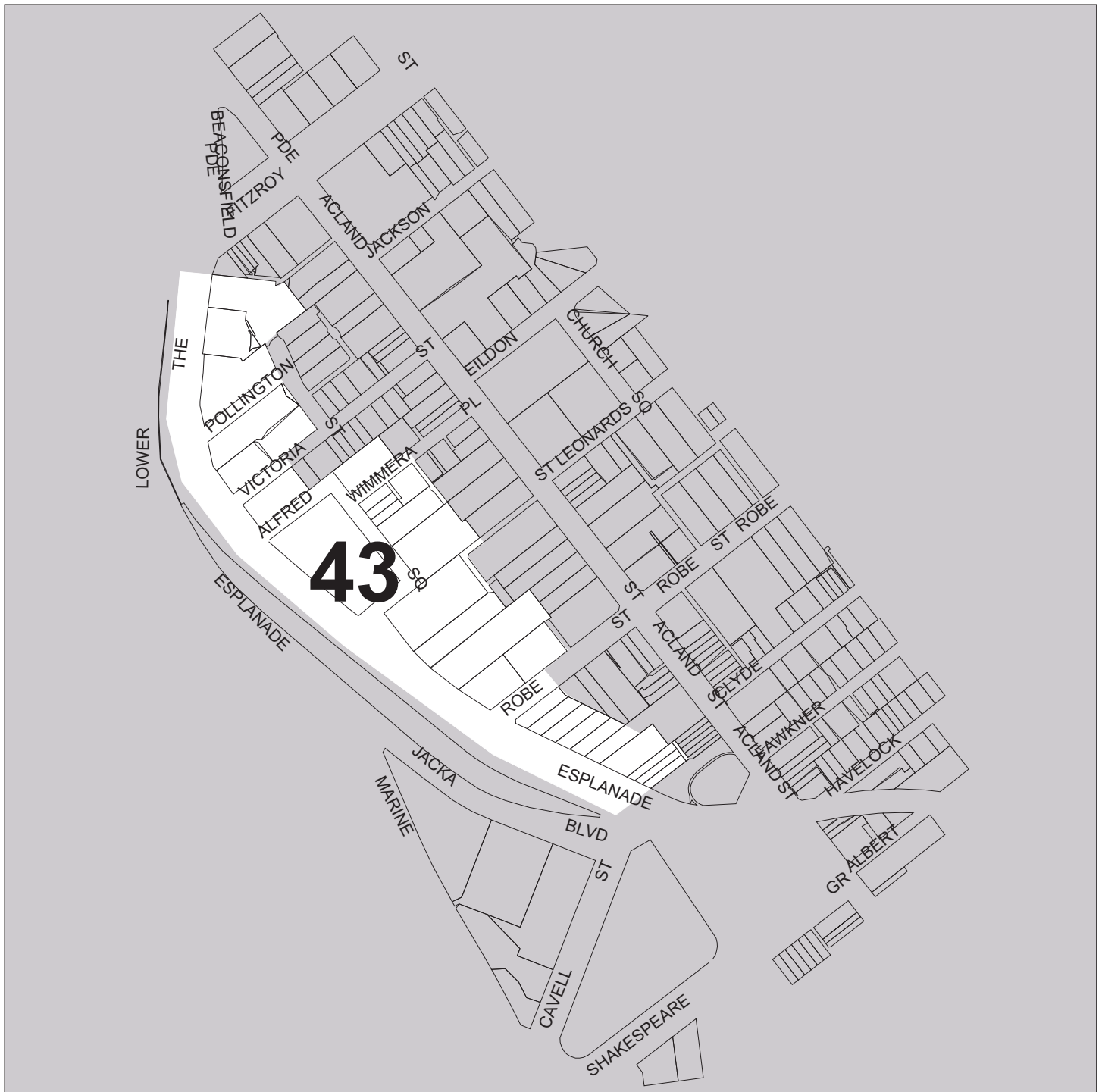

Boundary streets:

Esplanade, Fitzroy Street, Acland Street.

Streets in the area:

Alfred Sq, Esplanade,

Description of the character of the area:

This area is distinctive from the area to the east because of its foreshore views, landform and extremely mixed building scale.

The Esplanade is a wide road lined by mature palm trees. It has wide promenade style footpaths with a sea outlook to the west and a tram route. Alfred Reserve is a central part of this grand open space and a focus for the area.

The area has mixed lot sizes which are predominantly large. It was initially developed with large houses, apartments and hotels with some smaller houses on side streets dating from the Victorian period.

Substantial redevelopment during the post war period has included several lift access hotel and apartment buildings, which vary from six to fifteen storeys in height, and sit awkwardly with the one, two and three storey buildings of earlier periods.

<i>Element</i>	<i>Description</i>
Dominant style	1970s - 1990s
Dominant scale	more than three stories
Dominant material	stucco and render/minor variation
Dominant roof	pitched/metal
Setback	less than 5 metres/minor variation
Heritage	@90% identified as heritage place
Gardens	visible/medium/small
Fences	various

The existing urban character of the City of Port Phillip has been assessed using 24 character elements. The design should especially respond to the important and very important elements, which in this area are:

<i>Element</i>	<i>Importance</i>
Views	Very important
Street trees	Very important
Building style	Very important
Building scale	Very important
Heritage	Very important
Foreshore	Very important
Landform	Important
Lot size	Important
Street dimensions	Important
Parking	Important
Footpaths	Important
Setbacks	Important
Housing type	Important
Access	Important
Open space	Important

A comprehensive urban character assessment and policy statement for the area is available from the Council .



City of Port Phillip
URBAN CHARACTER DESCRIPTION

AREA 44: FITZROY STREET BETWEEN GREY STREET AND ST KILDA ROAD

The following description should be used in carrying out the site analysis and design response to your site. Pay attention to the very important and important character elements listed here, as well as the actual conditions observed at the site analysis stage.

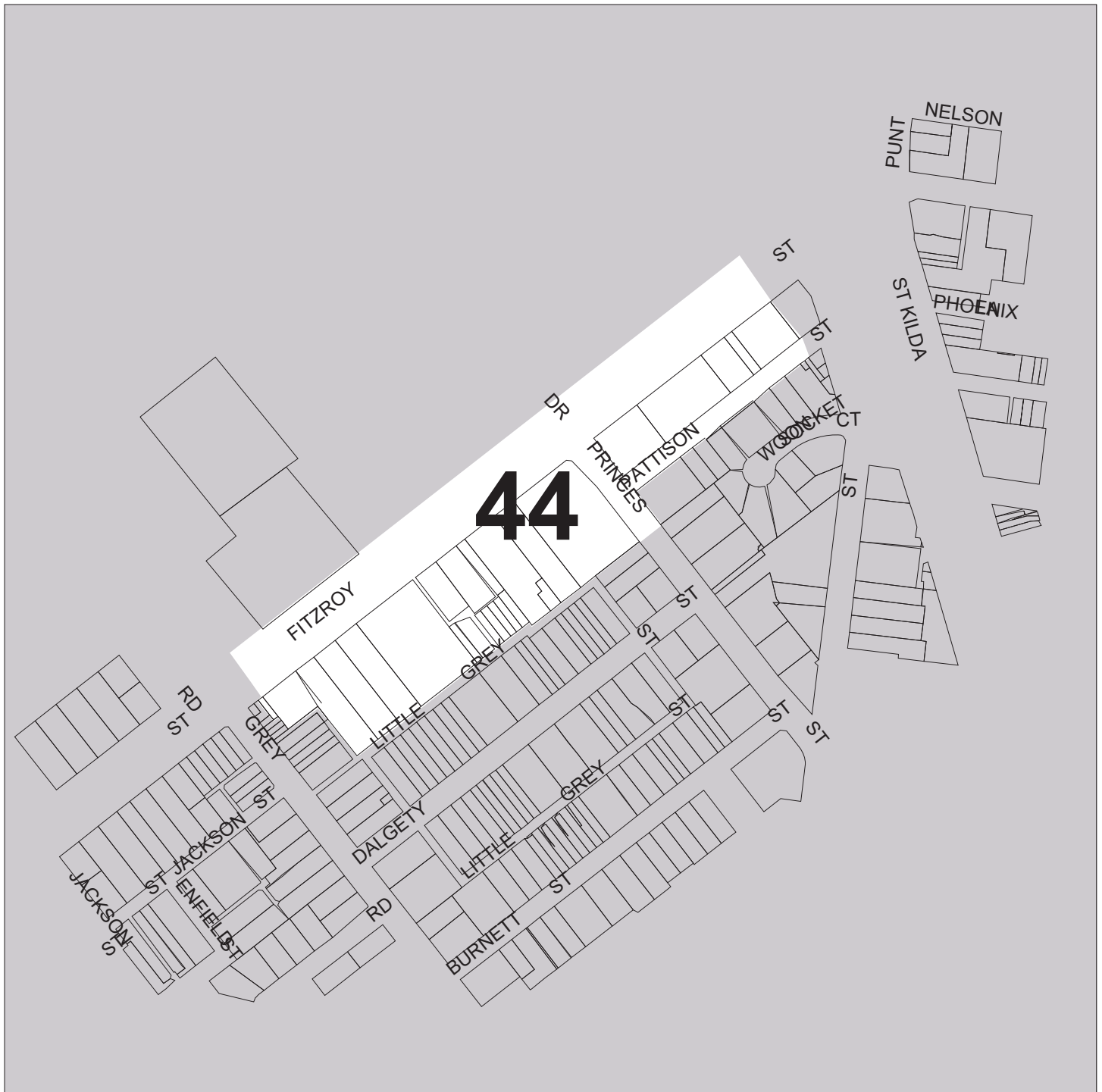

Boundary streets:

Fitzroy Street, Grey Street, Little Grey Street, St Kilda Road.

Streets in the area:

Fitzroy St, Pattison St, Princes St,

Description of the character of the area:

Fitzroy Street is a wide street with central tram reservation, nature strips, Plane trees along its south eastern side and generous footpaths.

This area faces Albert Park and the city beyond, creating a unique outlook and views.

It was originally developed with grand hotels and houses in the Victorian and Edwardian periods, and has since undergone substantial redevelopment in the post war period.

The scale of development is varied but many buildings are six or seven storeys high, giving the street a degree of continuity.

Buildings near St Kilda Road are occupied with office uses, but the majority of the buildings appear to be mixed use with café and entertainment uses on the ground floor and apartments above. Some new buildings incorporate basement or multi level car parks.

This is a high density area with exceptional access to shops, open space and public transport.

<i>Element</i>	<i>Description</i>
Dominant style	1970s - 1990s
Dominant scale	more than three stories
Dominant material	stucco and render/consistent
Dominant roof	flat/metal
Setback	less than 5 metres/consistent
Heritage	@75% identified as heritage place
Gardens	none
Fences	buildings to property line

The existing urban character of the City of Port Phillip has been assessed using 24 character elements. The design should especially respond to the important and very important elements, which in this area are:

<i>Element</i>	<i>Importance</i>
Street trees	Very important
Parking	Very important
Building scale	Very important
Heritage	Very important
Access	Very important
Open space	Very important
Views	Important
Lot size	Important
Street dimensions	Important
Traffic	Important
Setbacks	Important
Building style	Important
Housing type	Important
Land use	Important

A comprehensive urban character assessment and policy statement for the area is available from the Council .



City of Port Phillip
URBAN CHARACTER DESCRIPTION

AREA 45: FITZROY STREET BETWEEN THE ESPLANADE AND GREY STREET

The following description should be used in carrying out the site analysis and design response to your site. Pay attention to the very important and important character elements listed here, as well as the actual conditions observed at the site analysis stage.

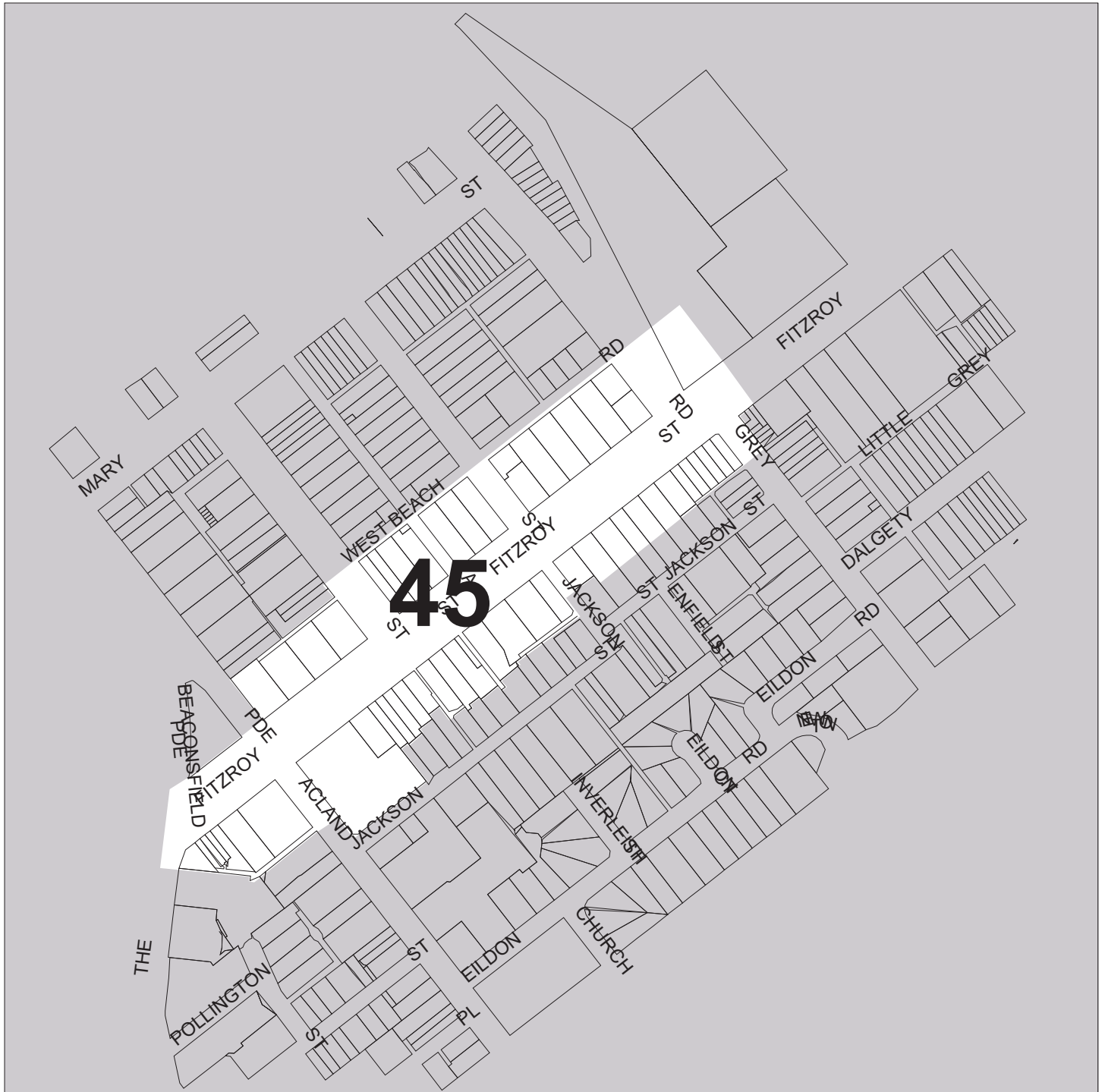

Boundary streets:

Fitzroy St west bounded by: West Beach Rd, The Esplanade, Catabury Rd, Jackson St.

Streets in the area:

Fitzroy St, Grey St, Jackson St,

Description of the character of the area:

The area is primarily differentiated from adjoining residential areas to the north and south by its mixed land use, different building types without setback and the grand proportion of Fitzroy Street.

Fitzroy Street has wide pedestrian pavements, providing for parking, two traffic lanes each direction and a central tram strip with central poles and street lighting.

The area was originally developed with large Victorian houses, many detached and setback from the street. Since then, it has undergone continuous redevelopment including Edwardian apartment buildings and shops followed by similar developments and renovations in the inter-war and post-war periods. The area now contains an almost equal mix of buildings from all periods.

Building scale in this area is smaller than the adjoining area to the east. Buildings of one, two and three storeys are almost equally represented along the street. Fitzroy Street has consistent development along its northern side including apartment buildings, restaurants and former large houses.

The street landscape on the northern side contains mature elm trees, limited verandahs and some setback buildings with gardens. In contrast, the southern side has almost continuous verandahs and commercial frontage with a more recent landscape of smaller trees and fully paved footpaths.

<i>Element</i>	<i>Description</i>
Dominant style	pre-1900s
Dominant scale	"one, two and three stories"
Dominant material	stucco and render/minor variation
Dominant roof	concealed by parapets/terracotta
Setback	less than 5 metres/minor variation
Heritage	@75% identified as heritage place
Gardens	visible/small
Fences	various height and materials

The existing urban character of the City of Port Phillip has been assessed using 24 character elements. The design should especially respond to the important and very important elements, which in this area are:

<i>Element</i>	<i>Importance</i>
Parking	Very important
Access	Very important
Views	Important
Street dimensions	Important
Traffic	Important
Footpaths	Important
Overhead services	Important
Signage	Important
Setbacks	Important
Heritage	Important
Land use	Important
Foreshore	Important

A comprehensive urban character assessment and policy statement for the area is available from the Council .



City of Port Phillip
URBAN CHARACTER DESCRIPTION

AREA 46: LAND GENERALLY BOUNDED BY MARINE PARADE, WORDSWORTH STREET AND BARKLEY STREET

The following description should be used in carrying out the site analysis and design response to your site. Pay attention to the very important and important character elements listed here, as well as the actual conditions observed at the site analysis stage.

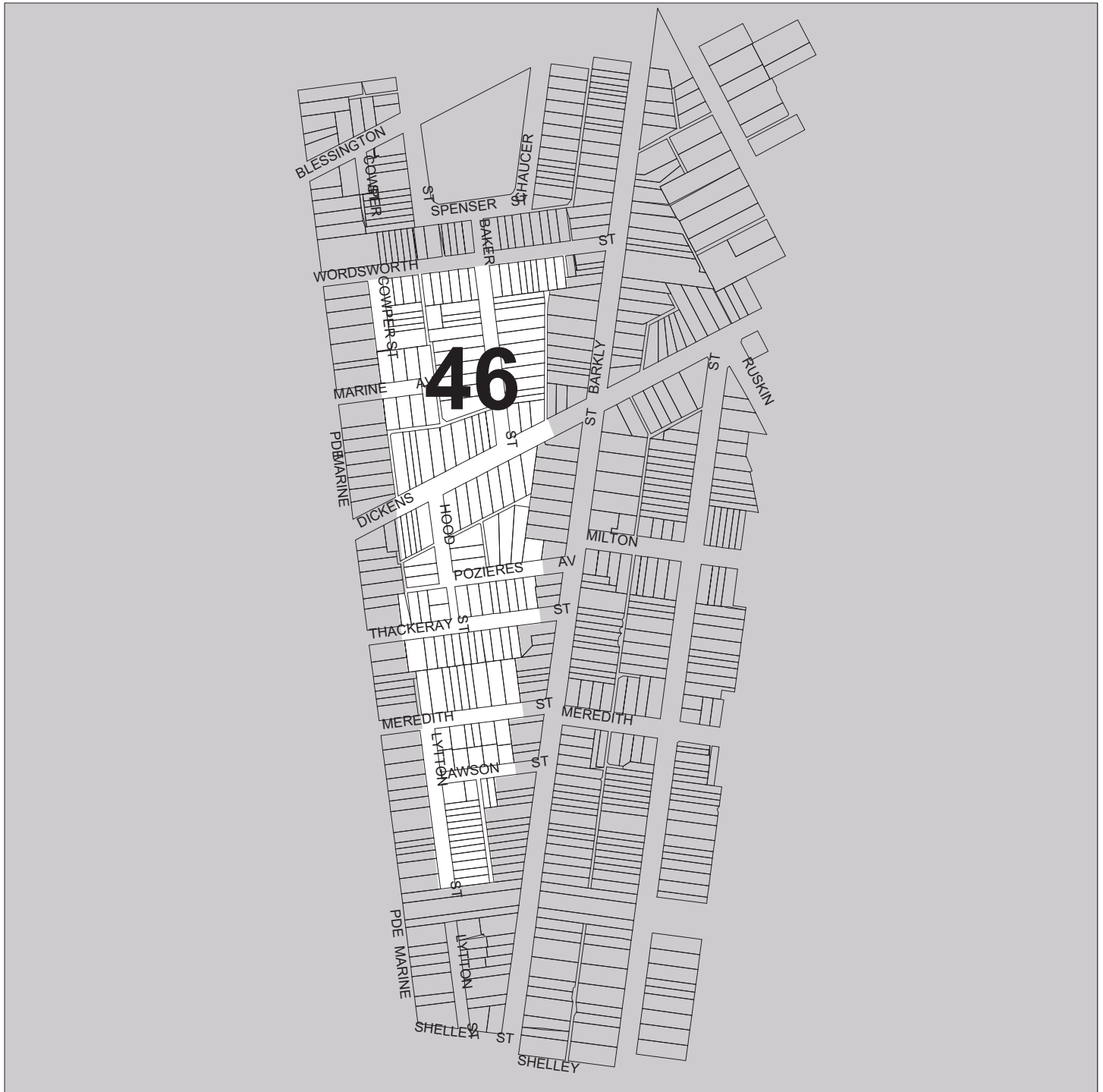

Boundary streets:

Marine Pde, Barkley St, Wordsworth St.

Streets in the area:

Baker St, Dickens St, Lawson St, Meredith St, Pozieres Av, Thackeray St,

Description of the character of the area:

Most of the area has been subdivided into smaller lots and developed primarily with single storey houses and consistent fencing through the Victorian, Edwardian and inter-war periods. It is relatively free from two and three storey post-war flat blocks.

Streets mostly retain their original bluestone and bitumen detailing and some streets have excellent mature plane trees.

The intimate scale of this area is created by its short, often narrow streets and small scale housing. This characteristic together with its relative freedom from post-war flat development are the outstanding characteristics of this area and the ones that differentiate it from adjoining areas.

<i>Element</i>	<i>Description</i>
Dominant style	1900s -1920s
Dominant scale	one storey
Dominant material	stucco and render/mixed
Dominant roof	pitched/terracotta
Setback	less than 5 metres/minor variation
Heritage	no identified heritage places
Gardens	visible/medium/small
Fences	low-medium/various materials

The existing urban character of the City of Port Phillip has been assessed using 24 character elements. The design should especially respond to the important and very important elements, which in this area are:

<i>Element</i>	<i>Importance</i>
Building scale	Very important
Street dimensions	Important
Street detailing	Important
Fences	Important
Building style	Important
Housing type	Important
Foreshore	Important

A comprehensive urban character assessment and policy statement for the area is available from the Council .



City of Port Phillip
URBAN CHARACTER DESCRIPTION

AREA 47: MARINE PARADE BETWEEN SHAKESPEARE GROVE AND GLENHUNTLY ROAD

The following description should be used in carrying out the site analysis and design response to your site. Pay attention to the very important and important character elements listed here, as well as the actual conditions observed at the site analysis stage.

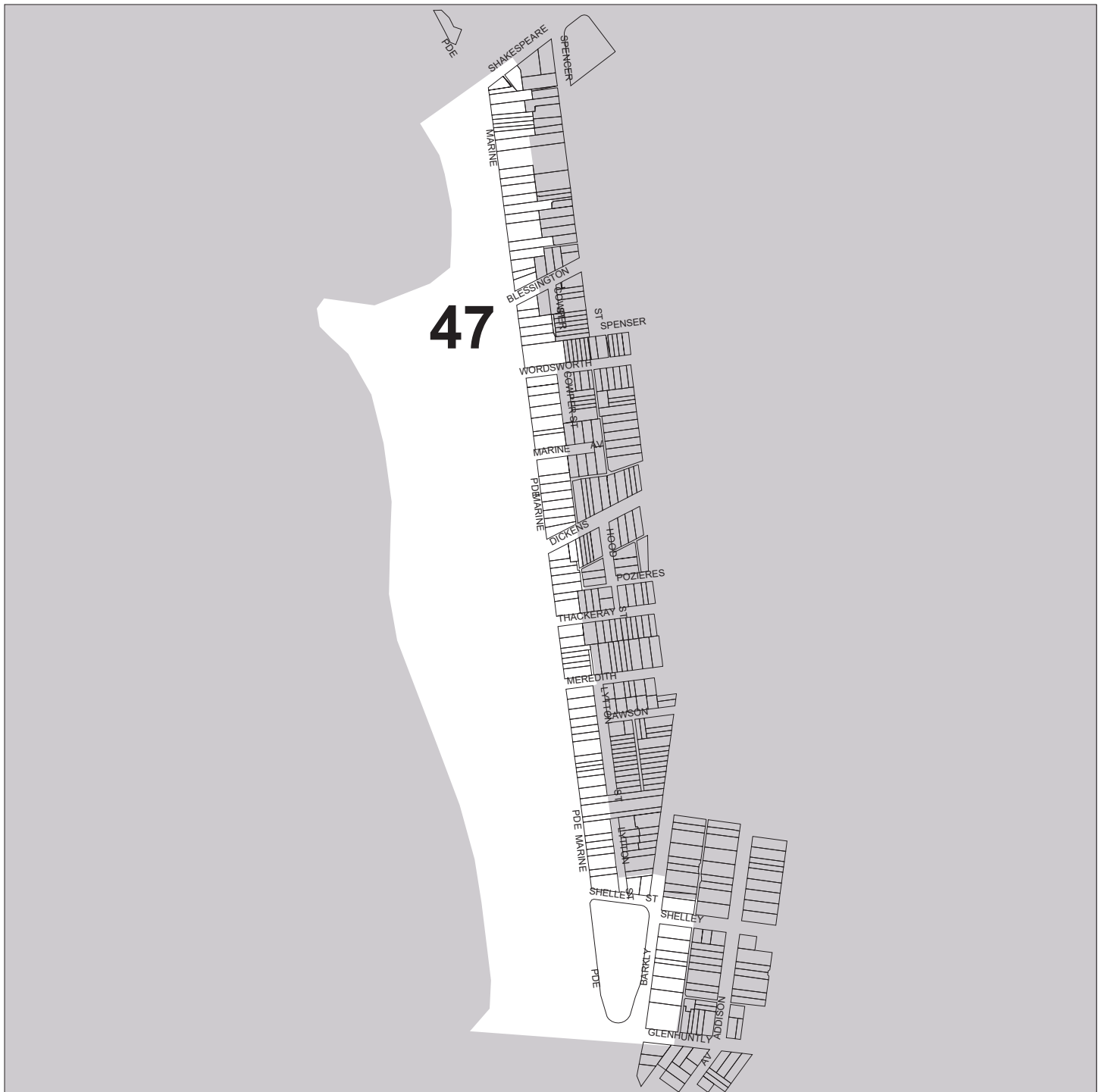

Boundary streets:

Marine Pde. between Glenhuntly Rd. and Shakespeare Gve.

Streets in the area:

Barkly St, Blessington Ct, Glenhuntly Rd, Hood St, Lytton St, Marine Av, Marine Pde, Shelley St, Spenser St,

Description of the character of the area:

This area includes two and three storey housing and apartment buildings bordering its eastern edge and extensive open space and foreshore recreation facilities to the west. It has undergone fairly continuous development since it was first established at the beginning of the century.

Marine Parade has been upgraded to a six lane arterial road carrying heavy through traffic which has a strong impact on the area. Landscaping along Marine Parade is immature and overhead services visually dominate much of the area.

Foreshore facilities include parking areas, passive parkland, beaches, shared pathways and restaurants.

The St Kilda Marina and the large service station are also prominent in the area.

Views are limited from Marine Parade but are excellent from the foreshore and upper levels of buildings in the area.

<i>Element</i>	<i>Description</i>
Dominant style	1920s - 1940s
Dominant scale	two storey
Dominant material	stucco and render/minor variation
Dominant roof	pitched/terracotta
Setback	less than 5 metres/minor variation
Heritage	no identified heritage places
Gardens	visible/medium/small
Fences	low-high/consistent materials

The existing urban character of the City of Port Phillip has been assessed using 24 character elements. The design should especially respond to the important and very important elements, which in this area are:

<i>Element</i>	<i>Importance</i>
Views	Very important
Traffic	Very important
Foreshore	Very important
Street dimensions	Important
Overhead services	Important
Fences	Important
Building style	Important
Building scale	Important
Housing type	Important
Open space	Important

A comprehensive urban character assessment and policy statement for the area is available from the Council .



City of Port Phillip
URBAN CHARACTER DESCRIPTION

AREA 48: CHAUCER STREET AND SPENSER STREET

The following description should be used in carrying out the site analysis and design response to your site. Pay attention to the very important and important character elements listed here, as well as the actual conditions observed at the site analysis stage.

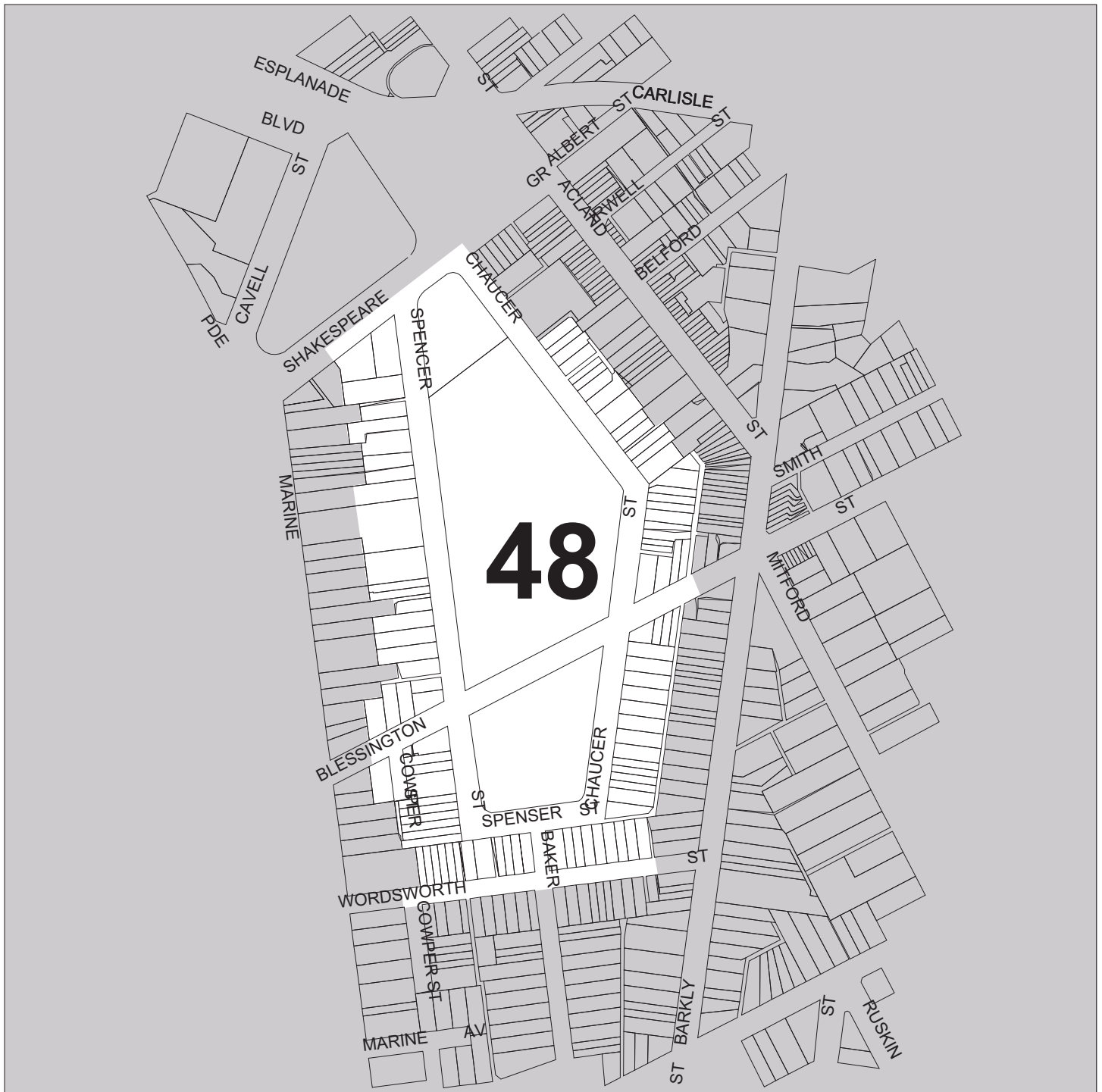

Boundary streets:

Chaucer Street, Wordsworth St, Spencer St, Shakespeare Gve.

Streets in the area:

Baker St, Blessington St, Chaucer St, Spencer St, Wordsworth St,

Description of the character of the area:

Lots in the area vary widely in size and frontage, but all lots have frontages to Chaucer or Spencer Streets and the open space beyond.

The area was initially developed during the Victorian period but the majority of houses are Edwardian. The area has undergone redevelopment for flat buildings both in the inter-war and post-war periods. These two or three storey blocks are mainly concentrated in Spencer Street . One large flat building, Edgewater Tower, adjoins the area and is very visible on the skyline. Luna Park at the northern end of the area is another landmark which adds to the character of the area.

Streets retain their original detailing but lack consistent street trees. The open space retains many trees from its initial phase of development but most buildings and facilities are from the post war period.

The area appears to accommodate parking generated by adjoining Acland Street and tourist areas.

<i>Element</i>	<i>Description</i>
Dominant style	1900s - 1920s
Dominant scale	one and three storey
Dominant material	brick or masonry/mixed
Dominant roof	pitched/terracotta
Setback	less than 5 metres/minor variation
Heritage	no identified heritage places
Gardens	visible/small
Fences	medium height/various materials

The existing urban character of the City of Port Phillip has been assessed using 24 character elements. The design should especially respond to the important and very important elements, which in this area are:

<i>Element</i>	<i>Importance</i>
Open space	Very important
Landform	Important
Views	Important
Parking	Important
Setbacks	Important
Building style	Important
Building scale	Important
Housing type	Important
Access	Important
Foreshore	Important

A comprehensive urban character assessment and policy statement for the area is available from the Council .



City of Port Phillip
URBAN CHARACTER DESCRIPTION

AREA 49: THE ESPLANADE BETWEEN FITZROY STREET AND SHAKESPEARE GROVE

The following description should be used in carrying out the site analysis and design response to your site. Pay attention to the very important and important character elements listed here, as well as the actual conditions observed at the site analysis stage.

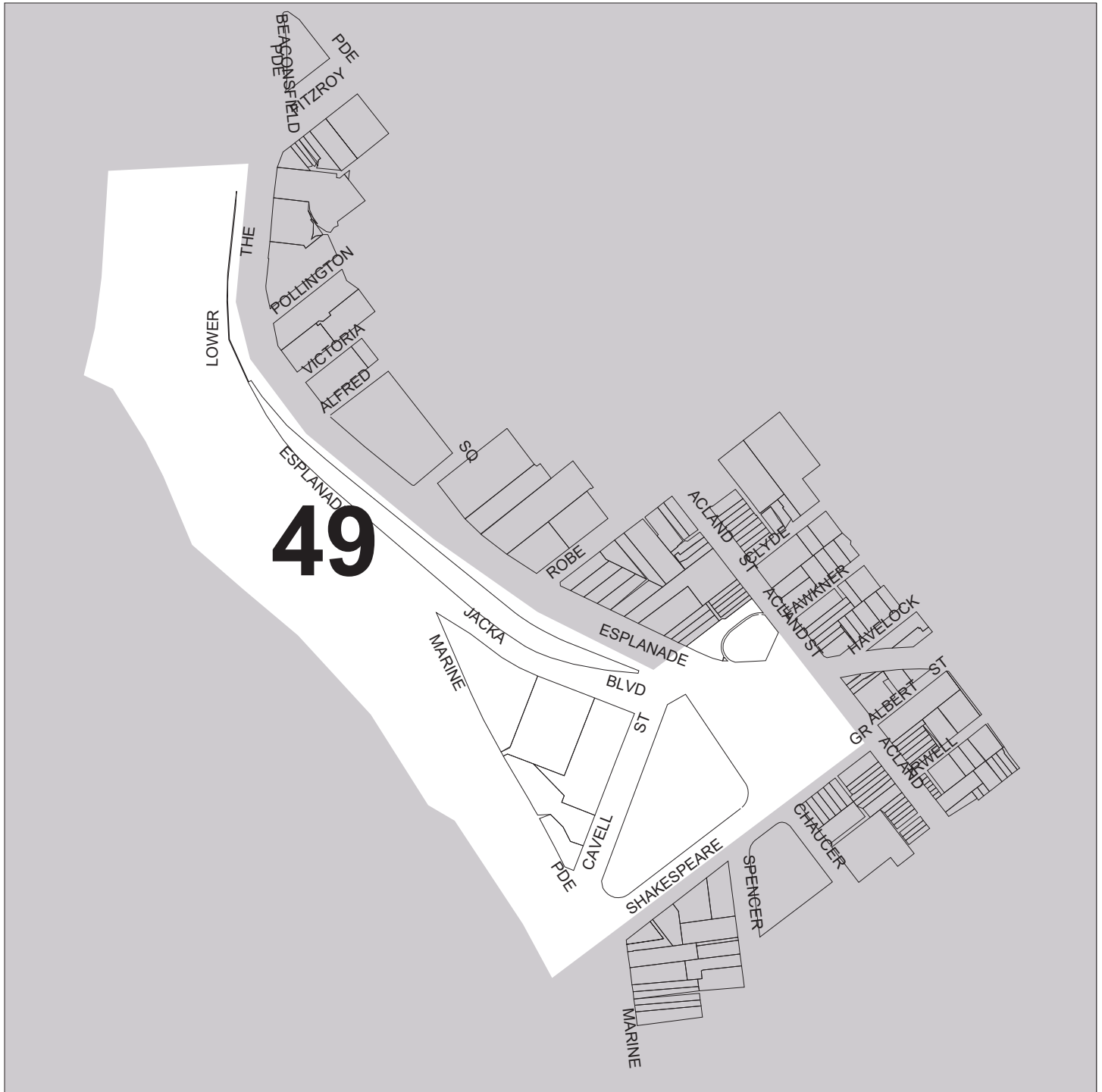

Boundary streets:

The Esplanade, Fitzroy St, Shakespeare Gve, Foreshore.

Streets in the area:

Acland St, Cavell St, Esplanade, Jacka Blvd, Lower Esplanade, Shakespeare Gv,

Description of the character of the area:

This section of the St Kilda Foreshore is distinguished from adjoining areas by its primary function as a recreation and entertainment area. The area has no housing and consists of a number of privately operated tourist venues including Luna Park, the Palais, the Palace, the Sea Baths and various restaurants on large lots, set amongst public parkland and beach reserves. Some sites within the area have been developed as unattractive temporary car parks

Roads in the area are large in dimension and Jacka Boulevard/Marine Parade carries heavy traffic through the area.

St Kilda beach, including the pier and restaurants, is an extremely popular tourist destination.

<i>Element</i>	<i>Description</i>
Dominant style	1920s - 1940s
Dominant scale	one and more than 3 stories
Dominant material	stucco and render/minor variation
Dominant roof	no dominance/metal
Setback	less than 5 metres/varied
Heritage	@50% identified as heritage place
Gardens	no boundary definition
Fences	buildings to property line

The existing urban character of the City of Port Phillip has been assessed using 24 character elements. The design should especially respond to the important and very important elements, which in this area are:

<i>Element</i>	<i>Importance</i>
Traffic	Very important
Parking	Very important
Heritage	Very important
Land use	Very important
Foreshore	Very important
Views	Important
Lot size	Important
Street dimensions	Important
Building style	Important
Building scale	Important
Access	Important
Open space	Important

A comprehensive urban character assessment and policy statement for the area is available from the Council .



City of Port Phillip
URBAN CHARACTER DESCRIPTION

AREA 50: LAND IN THE VICINITY OF PARK STREET, DEAKIN STREET, LOCH STREET AND MARY STREET

The following description should be used in carrying out the site analysis and design response to your site. Pay attention to the very important and important character elements listed here, as well as the actual conditions observed at the site analysis stage.

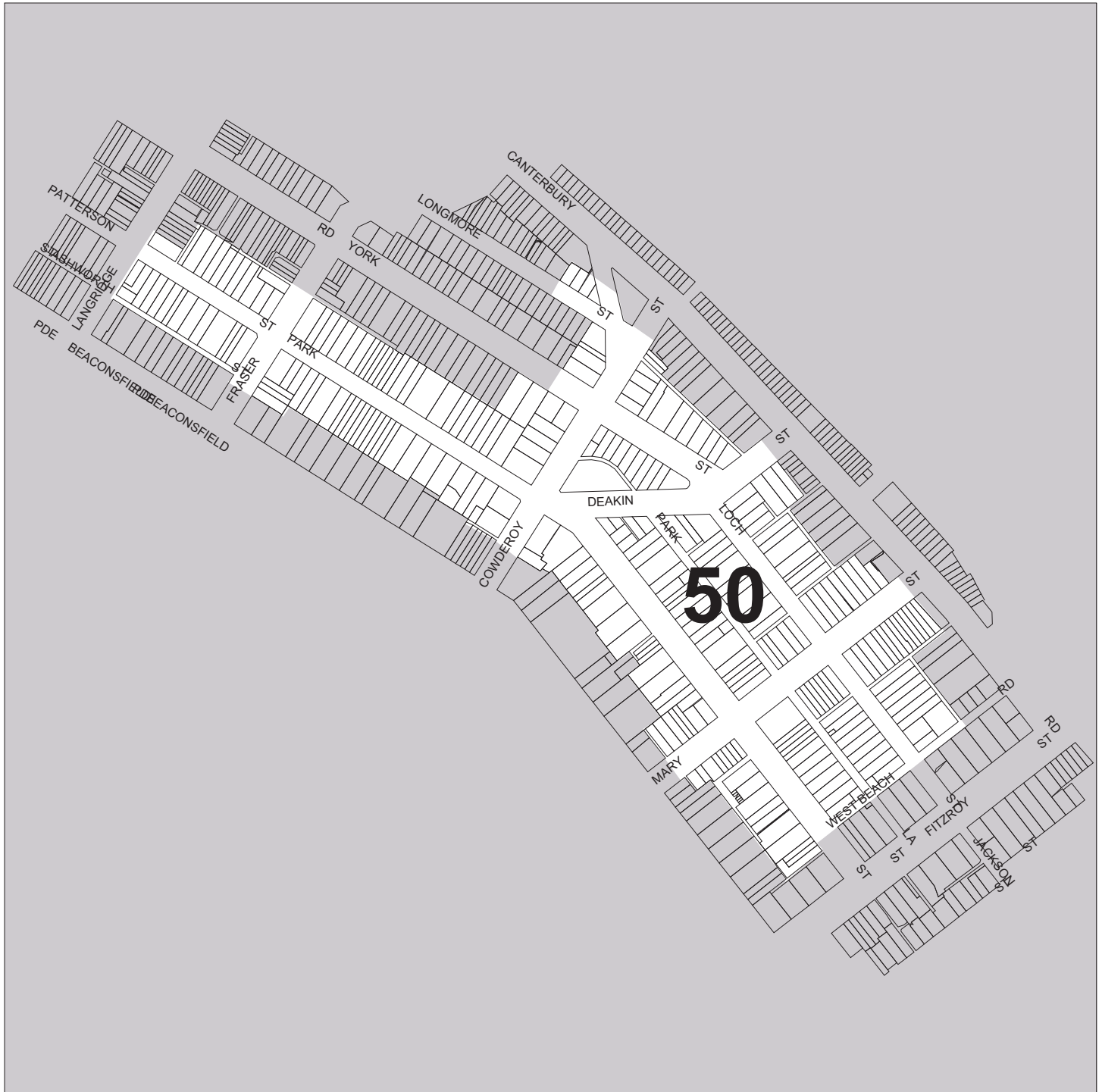

Boundary streets:

Canterbury Rd, Cowderoy St, Langridge St, Park St.

Streets in the area:

Cowderoy St, Deakin St, Fraser St, Loch St, Mary St, Park La, Park St, Patterson St, West Beach Rd, York St, Felix La, Bells La,

Description of the character of the area:

The area is significant for its street trees and collection of Edwardian houses and inter war apartment buildings. The northern edge is defined by a gradual reduction in building scale and a reduction in the presence of flat blocks.

Streets in the area are mostly wide with generous footpaths, medians and wide road pavements. There are also some smaller streets near Fitzroy Street and an extensive system of rear lanes.

Most views are internal although there are occasional glimpses to the foreshore skyline along the east/west streets. Some streets have exceptional street trees especially Park Street south, Mary and York Streets which are planted with a mix of mature plane and elm trees. Other trees are extremely mixed in their planting.

This area is extremely accessible to shops, services, beach, open space and public transport.

<i>Element</i>	<i>Description</i>
Dominant style	1900s - 1920s
Dominant scale	two and three storey
Dominant material	brick or masonry/minor variation
Dominant roof	pitched/terracotta
Setback	less than 5 metres/consistent
Heritage	entire area identified as heritage place
Gardens	visible/medium/small
Fences	medium height/various materials

The existing urban character of the City of Port Phillip has been assessed using 24 character elements. The design should especially respond to the important and very important elements, which in this area are:

<i>Element</i>	<i>Importance</i>
Street dimensions	Very important
Street trees	Very important
Heritage	Very important
Access	Very important
Building style	Important
Building scale	Important
Housing type	Important
Open space	Important
Foreshore	Important

A comprehensive urban character assessment and policy statement for the area is available from the Council .



City of Port Phillip
URBAN CHARACTER DESCRIPTION

AREA 51: CANTERBURY ROAD, FITZROY STREET, ALBERT PARK

The following description should be used in carrying out the site analysis and design response to your site. Pay attention to the very important and important character elements listed here, as well as the actual conditions observed at the site analysis stage.

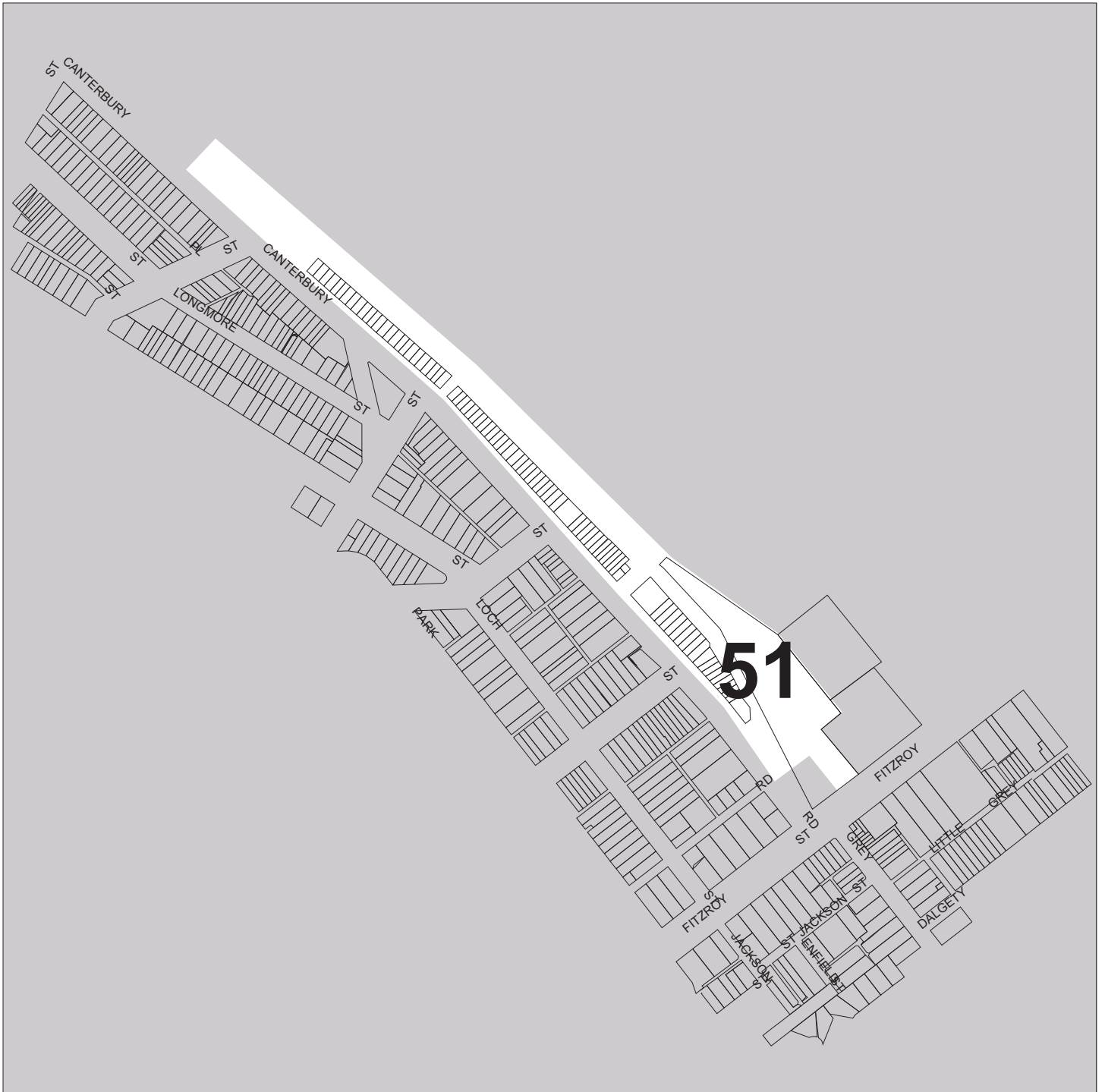

Boundary streets:

Canterbury Rd, Fitzroy St, Albert Park, Fraser St.

Streets in the area:

Balluk Willam Ct, Balluk William Ct,

Description of the character of the area:

This area was developed in the 1990s following subdivision of land surplus to the requirements of Public Transport Corporation.

Development consists of contemporary terrace style dwellings with frontage to Canterbury Road and car access from the rear in most instances. The houses are generally three storey with balconies and deck space providing views across the light rail line to Albert Park.

The character of the area is quite distinct from the residential area on the opposite side of Canterbury Road where buildings date back to Victorian and Edwardian periods.

The area has a unique relationship with Albert Park and exceptional access to shops open space and public transport.

<i>Element</i>	<i>Description</i>
Dominant style	1970s-1990s
Dominant scale	three storey
Dominant material	stucco and render/minor variation
Dominant roof	concealed by parapet
Setback	less than 5 metres/minor variation
Heritage	entire area identified as heritage place
Gardens	visible/hidden/no boundary definition/small
Fences	various heights/mixed materials

The existing urban character of the City of Port Phillip has been assessed using 24 character elements. The design should especially respond to the important and very important elements, which in this area are:

<i>Element</i>	<i>Importance</i>
Building style	Very important
Access	Very important
Open space	Very important
Views	Important
Pattern	Important
Traffic	Important
Setbacks	Important
Building scale	Important
Housing type	Important

A comprehensive urban character assessment and policy statement for the area is available from the Council .

Boundary streets:

Beaconsfield Pde, Fitzroy St, Kerford Rd, Ashworth St.

Streets in the area:

Ashworth St, Beaconsfield Pde,

Description of the character of the area:

The area is distinguished from adjoining residential areas by the larger scale of buildings facing Beaconsfield Parade and its foreshore location with views over the bay.

Housing in the area was initially developed in the Victorian period but has undergone incremental redevelopment with the result that a range of building styles are almost equally represented. Building types vary from single and double storey terraces through to larger detached Victorian and Edwardian houses. The area also includes many inter-war period apartments and post-war houses, multi-unit developments and high rise towers.

Beaconsfield Parade is a wide and busy arterial road with associated traffic noise and an evolving landscape character of palm trees framing views to the water. The new beach front promenade is also a significant part of this road reservation. The Middle Park foreshore and Catani Gardens are a major tourist destination generating significant on-street parking and tourist activity.

<i>Element</i>	<i>Description</i>
Dominant style	1920s - 1940s
Dominant scale	one storey - high rise
Dominant material	stucco and render/consistent
Dominant roof	concealed by parapet/terracotta
Setback	less than 5 metres/minor variation
Heritage	@90% identified heritage places
Gardens	visible/small
Fences	low-high/various materials

The existing urban character of the City of Port Phillip has been assessed using 24 character elements. The design should especially respond to the important and very important elements, which in this area are:

<i>Element</i>	<i>Importance</i>
Views	Very important
Street dimensions	Very important
Traffic	Very important
Street trees	Very important
Foreshore	Very important
Parking	Important
Footpaths	Important
Building style	Important
Building scale	Important
Housing type	Important
Heritage	Important
Land use	Important
Open space	Important

A comprehensive urban character assessment and policy statement for the area is available from the Council .



City of Port Phillip
URBAN CHARACTER DESCRIPTION

AREA 53: WELLINGTON STREET BETWEEN QUEENS WAY AND THE JUNCTION

The following description should be used in carrying out the site analysis and design response to your site. Pay attention to the very important and important character elements listed here, as well as the actual conditions observed at the site analysis stage.

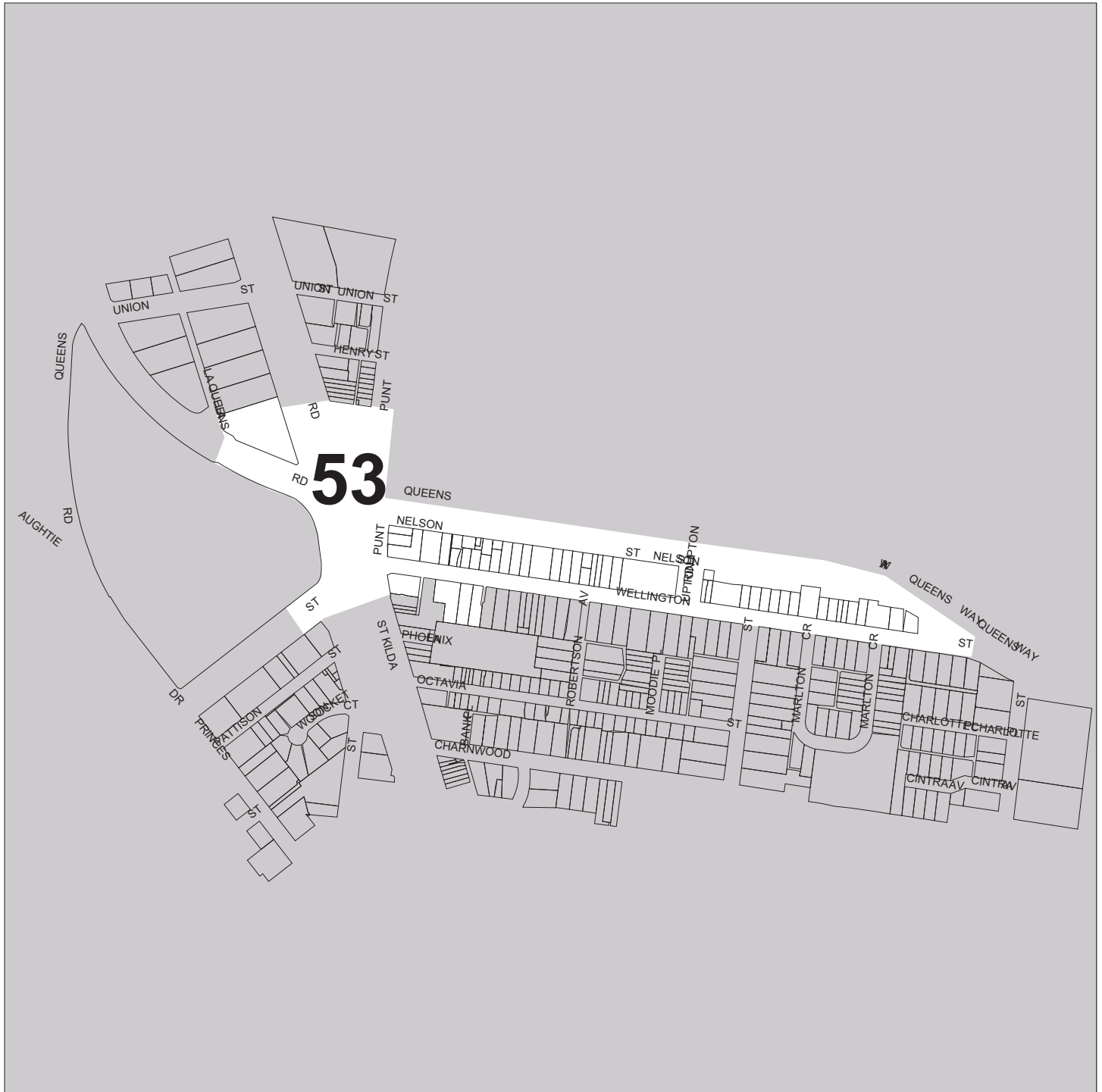

Wellington St, Queens Rd, St Kilda Rd.

Streets in the area:

St Kilda Rd, Wellington St,

Description of the character of the area:

This area is primarily influenced by St Kilda junction and includes commercial buildings which address the junction proper and a strip of development along the north side of Wellington Street which is also very visible from the junction.

Few buildings properly address this major intersection and those that do have been substantially devalued by large commercial advertising signs.

The area has been redeveloped by road authorities in the post-war period and is now a multi-level interchange and landmark location in the geography of Melbourne, being the intersection of Dandenong Road, Queens Road and St. Kilda Road. It incorporates tram routes and heavy traffic flows through the area make pedestrian movements difficult.

Landscape development of the intersection is a mixture of native trees, shrubs and planted embankments which are subservient to the functional design and scale of the intersection.

<i>Element</i>	<i>Description</i>
Dominant style	1970s - 1990s
Dominant scale	two or more stories
Dominant material	stucco and render/mixed
Dominant roof	concealed by parapets/metal
Setback	less than 5 metres/minor variation
Heritage	no identified heritage places
Gardens	no boundary definition
Fences	buildings to property line

The existing urban character of the City of Port Phillip has been assessed using 24 character elements. The design should especially respond to the important and very important elements, which in this area are:

<i>Element</i>	<i>Importance</i>
Street dimensions	Very important
Traffic	Very important
Signage	Very important
Street detailing	Important
Access	Important

A comprehensive urban character assessment and policy statement for the area is available from the Council .



City of Port Phillip
URBAN CHARACTER DESCRIPTION

AREA 54: QUEENS ROAD AND ST KILDA ROAD BETWEEN ALBERT ROAD AND THE JUNCTION

The following description should be used in carrying out the site analysis and design response to your site. Pay attention to the very important and important character elements listed here, as well as the actual conditions observed at the site analysis stage.

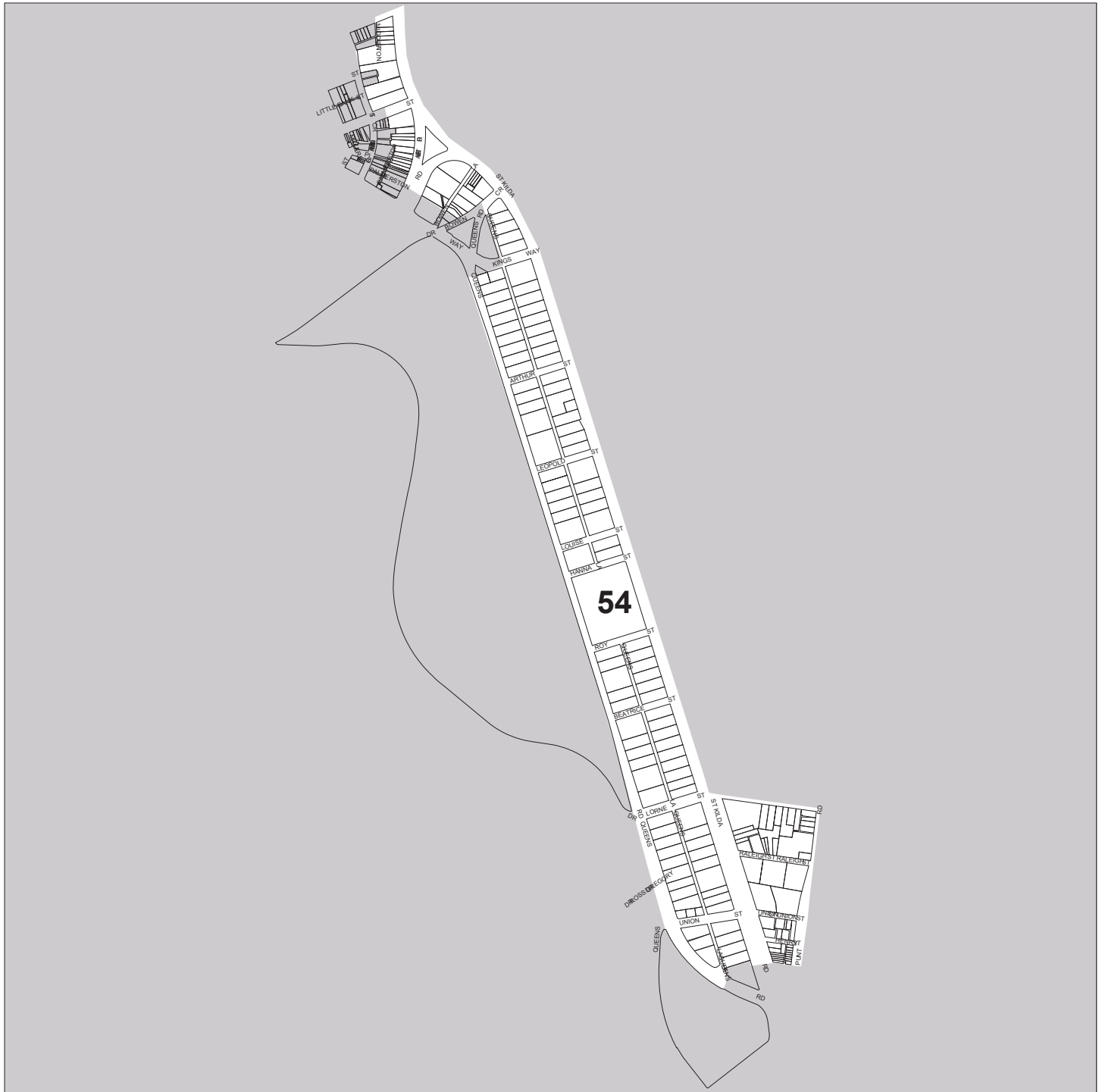

Boundary streets:

St Kilda Rd, Queens Rd, Punt Rd, High St, Dorcas St, Palmerston Crescent.

Streets in the area:

Albert Rd, Arthur St, Beatrice St, Bowen La, Hanna St, Henry St, High St, Kings Way, Leopold St, Lorne St, Louise St, Park St, Queens La, Raleigh St, Roy St, St Kilda Rd, Union St, Queens Rd,

Description of the character of the area:

The area is primarily distinguished from adjoining areas by its land use, large lot size and the scale and nature of buildings in the area.

It has two distinct parts, properties which face St Kilda Road and those which face Queens Road and Albert Park.

The area was originally subdivided and developed in the Victorian period as a grand street of large mansions on consistent large lots. However, it has undergone substantial redevelopment with houses being replaced by both high density apartment and office buildings. This redevelopment has been substantial during the post-war period so that large modern buildings now dominate the character.

Garden setbacks have been retained along both Queens Road and especially St. Kilda Road contributing a sense of continuity. The grand dimensions and consistent street trees and street details in St Kilda Road also add substantially to the area's character.

Other streets in the area lack consistent details and street trees.

<i>Element</i>	<i>Description</i>
Dominant style	1970s - 1990s
Dominant scale	three or more stories
Dominant material	stucco and render/glass/mixed
Dominant roof	no dominance/metal
Setback	more than 9 metres/varied
Heritage	no heritage places identified
Gardens	visible/exotic
Fences	various heights/various materials

The existing urban character of the City of Port Phillip has been assessed using 24 character elements. The design should especially respond to the important and very important elements, which in this area are:

<i>Element</i>	<i>Importance</i>
Lot size	Very important
Street dimensions	Very important
Traffic	Very important
Building style	Very important
Building scale	Very important
Open space	Very important
Views	Important
Pattern	Important
Street trees	Important
Front gardens	Important
Housing type	Important
Heritage	Important
Land use	Important
Access	Important

A comprehensive urban character assessment and policy statement for the area is available from the Council .



City of Port Phillip
URBAN CHARACTER DESCRIPTION

AREA 55: LAND GENERALLY BOUNDED BY CANTERBURY PLACE, KERFORD ROAD AND ASHWORTH STREET, MIDDLE PARK

The following description should be used in carrying out the site analysis and design response to your site. Pay attention to the very important and important character elements listed here, as well as the actual conditions observed at the site analysis stage.

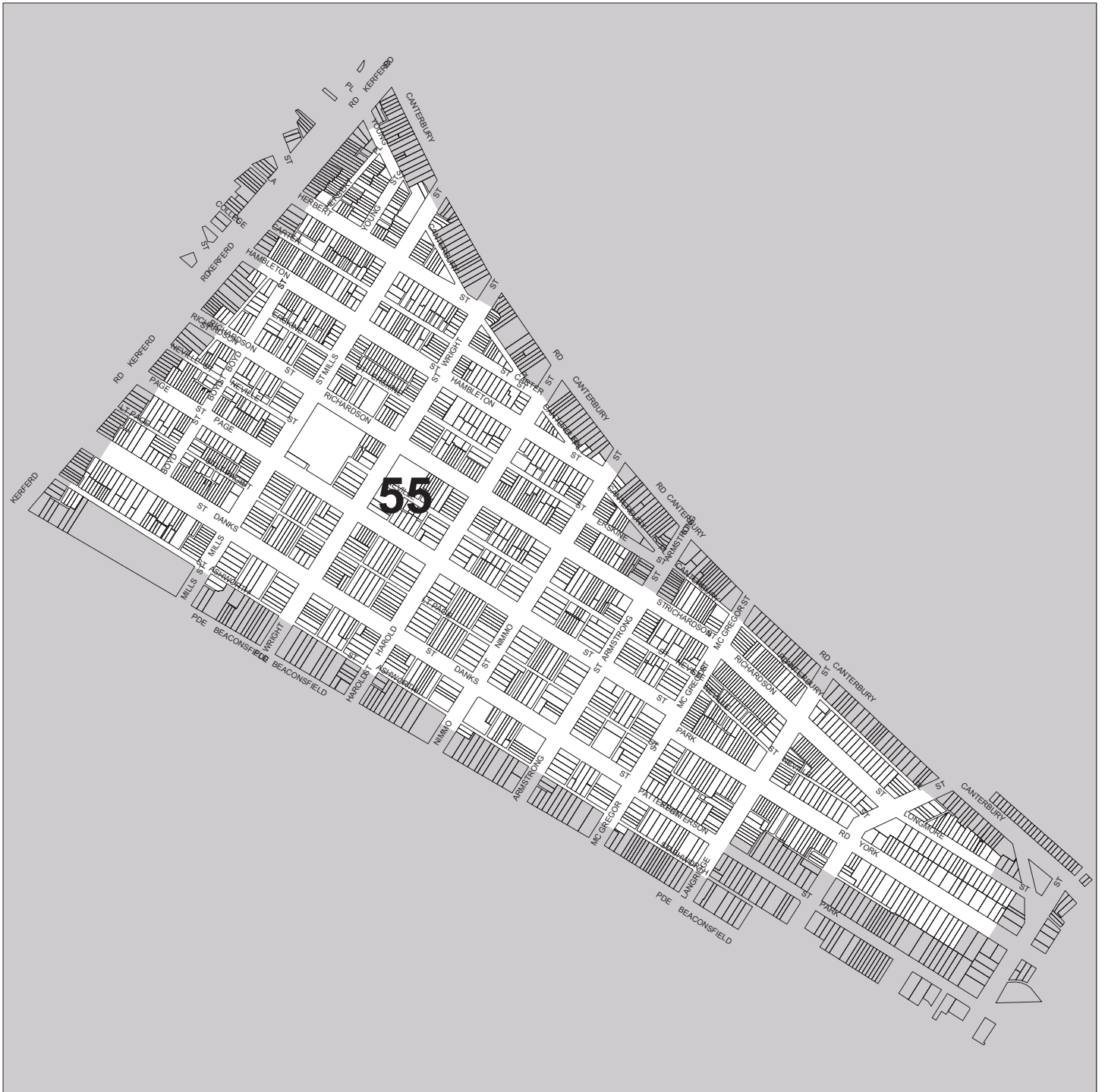

Canterbury Pl, Ashworth St, Cowderoy St, Kerford Rd.

Streets in the area:

Armstrong St, Boyd St, Canterbury Pl, Carter St, Cowderoy Pl, Danks St, Erskine St, Fraser St, Hambleton St, Harold St, Herbert Pl, Herbert St, Langridge St, Little Page St, Longmore St, Mcgregor St, Mills St, Neville St, Nimmo St, Page St, Park Rd, Patterson St, Richardson St, Wright St, York St,

Description of the character of the area:

The area has a consistent grid street pattern of wide, often tree-lined streets with a secondary system of smaller streets and lanes.

The vast majority of houses in this area are from either the Victorian or Edwardian periods in almost equal proportions. Smaller Victorian cottages are often timber creating a similar mix of brick, stucco and timber materials together with terracotta and metal roofs.

As there has been no significant redevelopment, the consistent Victorian and Edwardian housing dominates the character of the area.

The area has good access to public transport, Albert Park and the foreshore but limited convenience shopping and community facilities.

<i>Element</i>	<i>Description</i>
Dominant style	1900s - 1920s
Dominant scale	one storey
Dominant material	brick or masonry/mixed
Dominant roof	concealed by parapets/metal
Setback	less than 5 metres/consistent
Heritage	entire area identified as heritage place
Gardens	visible/small
Fences	medium height/consistent materials

The existing urban character of the City of Port Phillip has been assessed using 24 character elements. The design should especially respond to the important and very important elements, which in this area are:

<i>Element</i>	<i>Importance</i>
Pattern	Very important
Street dimensions	Very important
Building style	Very important
Building scale	Very important
Heritage	Very important
Street trees	Important
Nature strips	Important
Fences	Important
Setbacks	Important
Front gardens	Important
Housing type	Important
Land use	Important
Access	Important
Open space	Important
Foreshore	Important

A comprehensive urban character assessment and policy statement for the area is available from the Council .



City of Port Phillip
URBAN CHARACTER DESCRIPTION

AREA 56: LAND IN THE VICINITY OF ARMSTRONG STREET, CANTERBURY ROAD AND RICHARDSON STREET

The following description should be used in carrying out the site analysis and design response to your site. Pay attention to the very important and important character elements listed here, as well as the actual conditions observed at the site analysis stage.

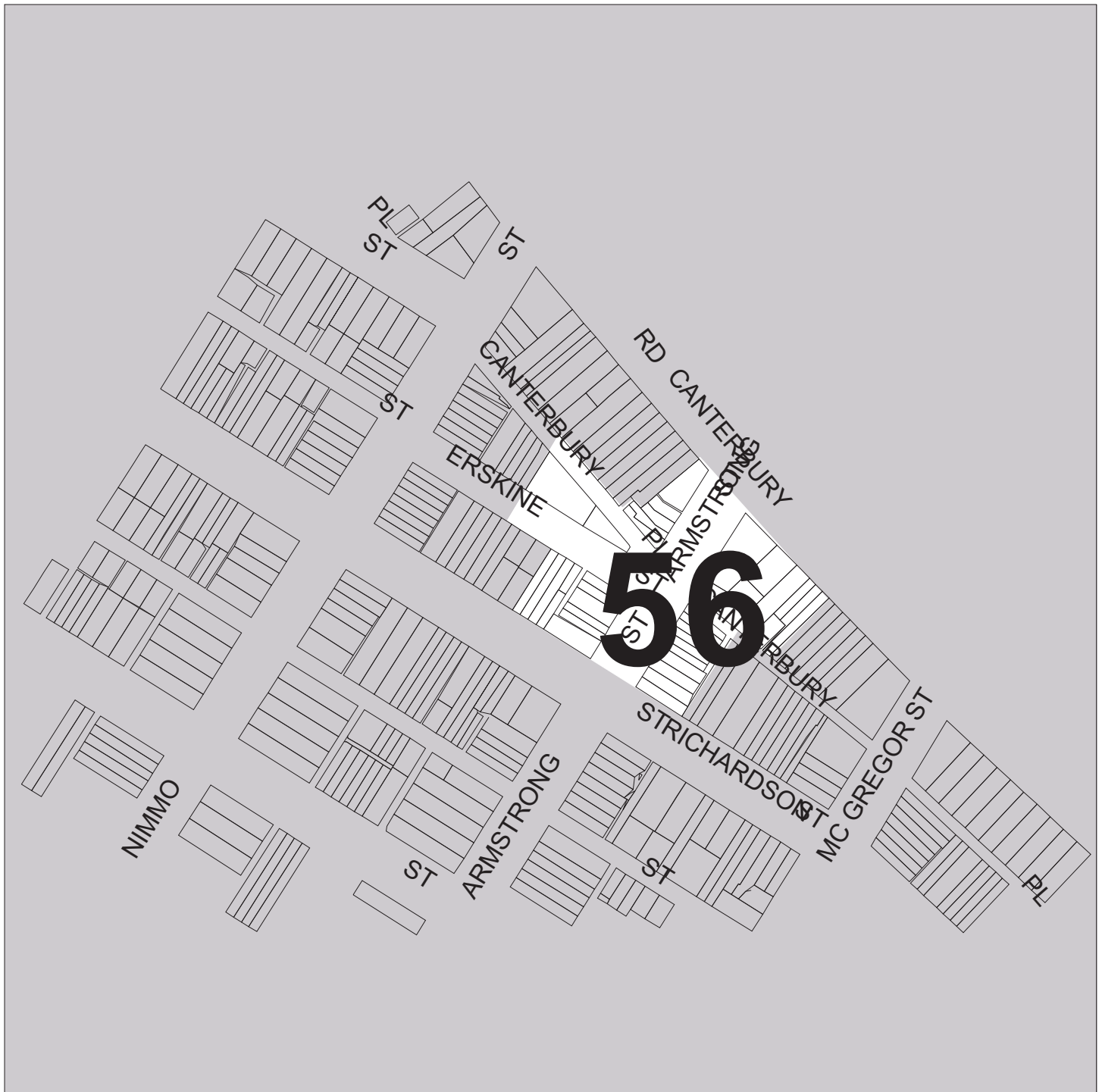

Boundary streets:

Richardson St, Canterbury Rd, Armstrong St.

Streets in the area:

Armstrong St, Canterbury Pl, Canterbury Rd,

Description of the character of the area:

This small shopping centre serving Middle Park, includes most local shopping requirements, some offices, a grand hotel and a range of restaurants.

Armstrong and Richardson Streets are wide streets which allow parallel parking, wide footpaths and street trees. They carry limited through traffic, giving the area a relatively quiet feel despite its proximity to Canterbury Road.

Buildings closest to Middle Park Station and Canterbury Road derive from the Victorian period, with the balance of the centre being fairly consistent Edwardian style shops

<i>Element</i>	<i>Description</i>
Dominant style	1900s - 1920s
Dominant scale	two storey
Dominant material	brick or masonry/consistent
Dominant roof	concealed by parapets/metal
Setback	less than 5 metres/consistent
Heritage	entire area identified as heritage place
Gardens	none
Fences	buildings to property line

The existing urban character of the City of Port Phillip has been assessed using 24 character elements. The design should especially respond to the important and very important elements, which in this area are:

<i>Element</i>	<i>Importance</i>
Heritage	Very important
Lot size	Important
Parking	Important
Fences	Important
Building style	Important
Building scale	Important
Land use	Important
Access	Important

A comprehensive urban character assessment and policy statement for the area is available from the Council .



City of Port Phillip
URBAN CHARACTER DESCRIPTION

AREA 57: CANTERBURY ROAD BETWEEN KERFORD ROAD AND FITZROY STREET

The following description should be used in carrying out the site analysis and design response to your site.
Pay attention to the very important and important character elements listed here, as well as the actual conditions observed at the site analysis stage.

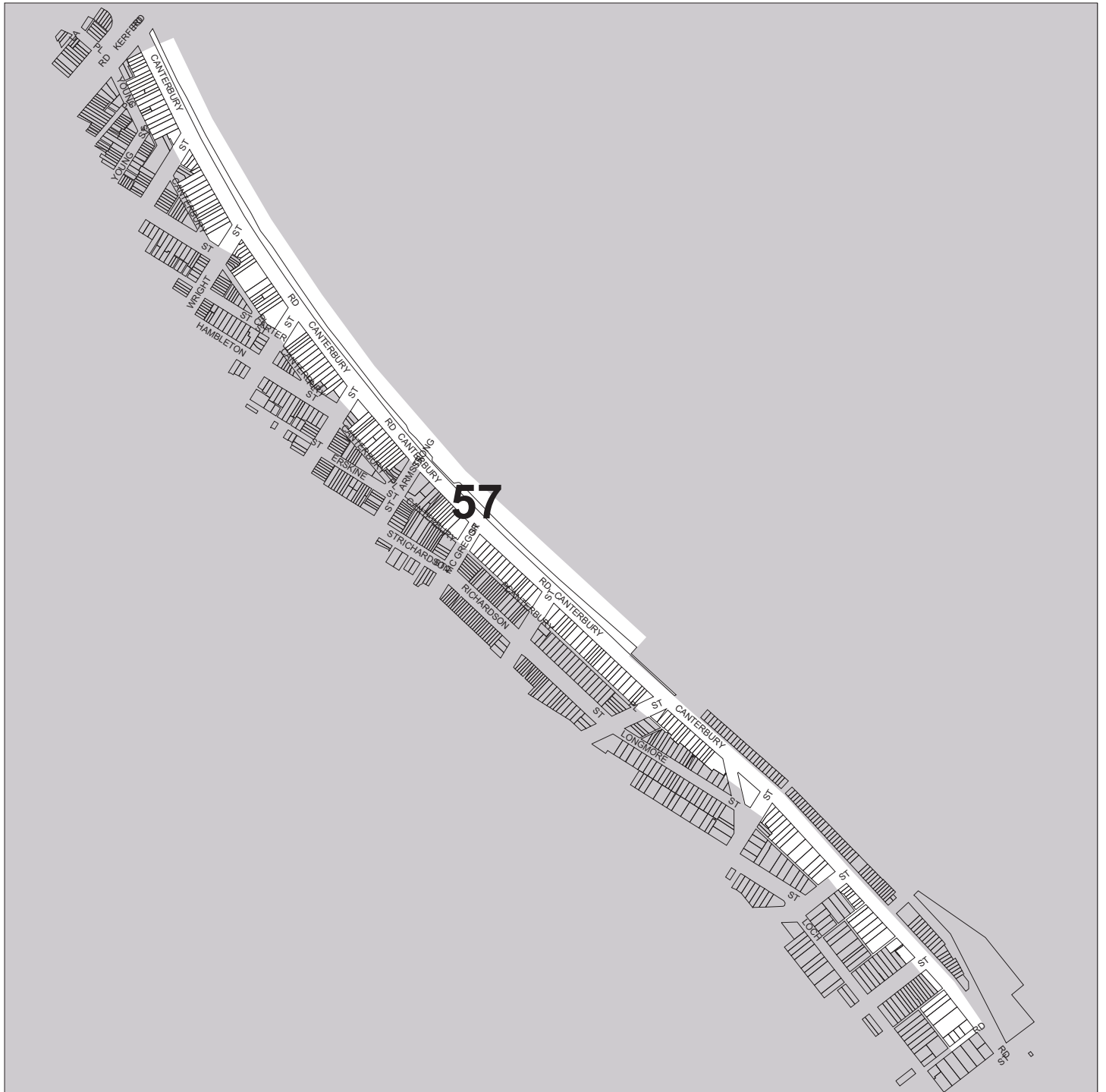

Boundary streets:

Canterbury Road between Fitzroy St and Kerford Rd.

Streets in the area:

Canterbury Rd, Cowderoy St, Deakin St, Harold St, Langridge St, Mcgregor St, West Beach Rd,

Description of the character of the area:

The area is distinguished from the adjoining residential areas by the slightly larger scale of buildings, their orientation towards Albert Park and the heavy traffic volumes along Canterbury Road.

It was predominantly developed in the Victorian and Edwardian periods with medium and large sized detached and terraced family houses. Most of these houses remain today and the area is an integral part of a large consistent heritage area covering all of Middle Park.

Canterbury Road has been redeveloped to cater for increasing traffic volumes and now has concrete kerbs and a median throughout its length.

Recent street trees planting has been incorporated within the parking lanes. Street trees are still quite mixed but an attempt has been made with recent planting to establish greater consistency.

<i>Element</i>	<i>Description</i>
Dominant style	pre-1900s
Dominant scale	one and two storey
Dominant material	stucco and render/minor variation
Dominant roof	pitched/metal
Setback	less than 5 metres/consistent
Heritage	entire area identified as heritage place
Gardens	visible/medium/small
Fences	medium height/consistent materials

The existing urban character of the City of Port Phillip has been assessed using 24 character elements. The design should especially respond to the important and very important elements, which in this area are:

<i>Element</i>	<i>Importance</i>
Traffic	Very important
Open space	Very important
Setbacks	Important
Front gardens	Important
Building style	Important
Building scale	Important
Housing type	Important
Heritage	Important
Land use	Important
Access	Important

A comprehensive urban character assessment and policy statement for the area is available from the Council .



City of Port Phillip
URBAN CHARACTER DESCRIPTION

AREA 58: KERFERD ROAD BETWEEN CANTERBURY ROAD AND BEACONSFIELD PARADE

The following description should be used in carrying out the site analysis and design response to your site. Pay attention to the very important and important character elements listed here, as well as the actual conditions observed at the site analysis stage.

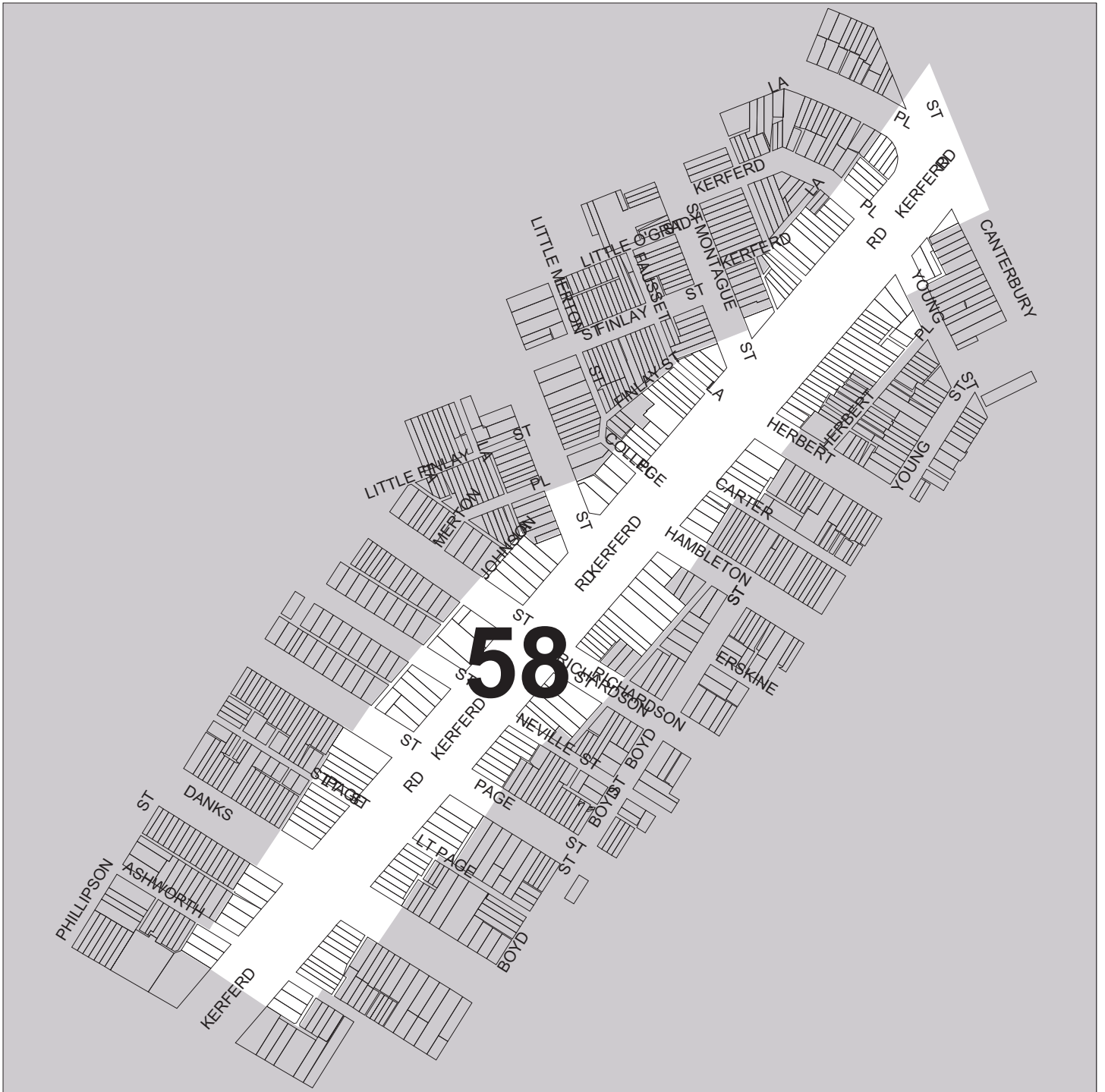

Boundary streets:

Kerford Rd, Canterbury Rd, Beaconsfield Pde.

Streets in the area:

Kerferd Rd, Neville St, Richardson St, Young St,

Description of the character of the area:

This area is distinguished from adjoining residential areas by the extraordinary scale of the street reservation and its wide median providing internal views. Traffic is another factor that separates it from adjoining, quieter areas.

It has been developed with a range of housing styles and types from Victorian, Edwardian and inter-war periods. Although lots are mixed and relatively small, some of the houses in the street are quite grand. Houses and apartments are generally well maintained with consistent front fences and attractive gardens.

Street trees vary along the street with mature Plane trees east of Richardson Street and young flowering gums of Norfolk Pines to the west. Street trees planted in nature strips are extremely mixed and inconsistent and suffer from the influence of power lines along both sides of the street.

Much of the original detailing including bluestone kerbs and wide channel drains remain, however traffic management devices and signs have a significant negative presence.

<i>Element</i>	<i>Description</i>
Dominant style	pre-1900s
Dominant scale	one and two storey
Dominant material	brick or masonry
Dominant roof	pitched/metal
Setback	less than 5 metres/minor variation
Heritage	entire area identified as heritage place
Gardens	visible/medium/small
Fences	medium height/consistent materials

The existing urban character of the City of Port Phillip has been assessed using 24 character elements. The design should especially respond to the important and very important elements, which in this area are:

<i>Element</i>	<i>Importance</i>
Street dimensions	Very important
Building style	Very important
Heritage	Very important
Views	Important
Pattern	Important
Traffic	Important
Street trees	Important
Fences	Important
Setbacks	Important
Front gardens	Important
Building scale	Important
Housing type	Important
Land use	Important
Open space	Important
Foreshore	Important

A comprehensive urban character assessment and policy statement for the area is available from the Council .



City of Port Phillip
URBAN CHARACTER DESCRIPTION

AREA 59: LAND GENERALLY BOUNDED BY VICTORIA AVENUE, BRIDPORT PLACE, KERFERD ROAD AND ASHWORTH STREET

The following description should be used in carrying out the site analysis and design response to your site. Pay attention to the very important and important character elements listed here, as well as the actual conditions observed at the site analysis stage.

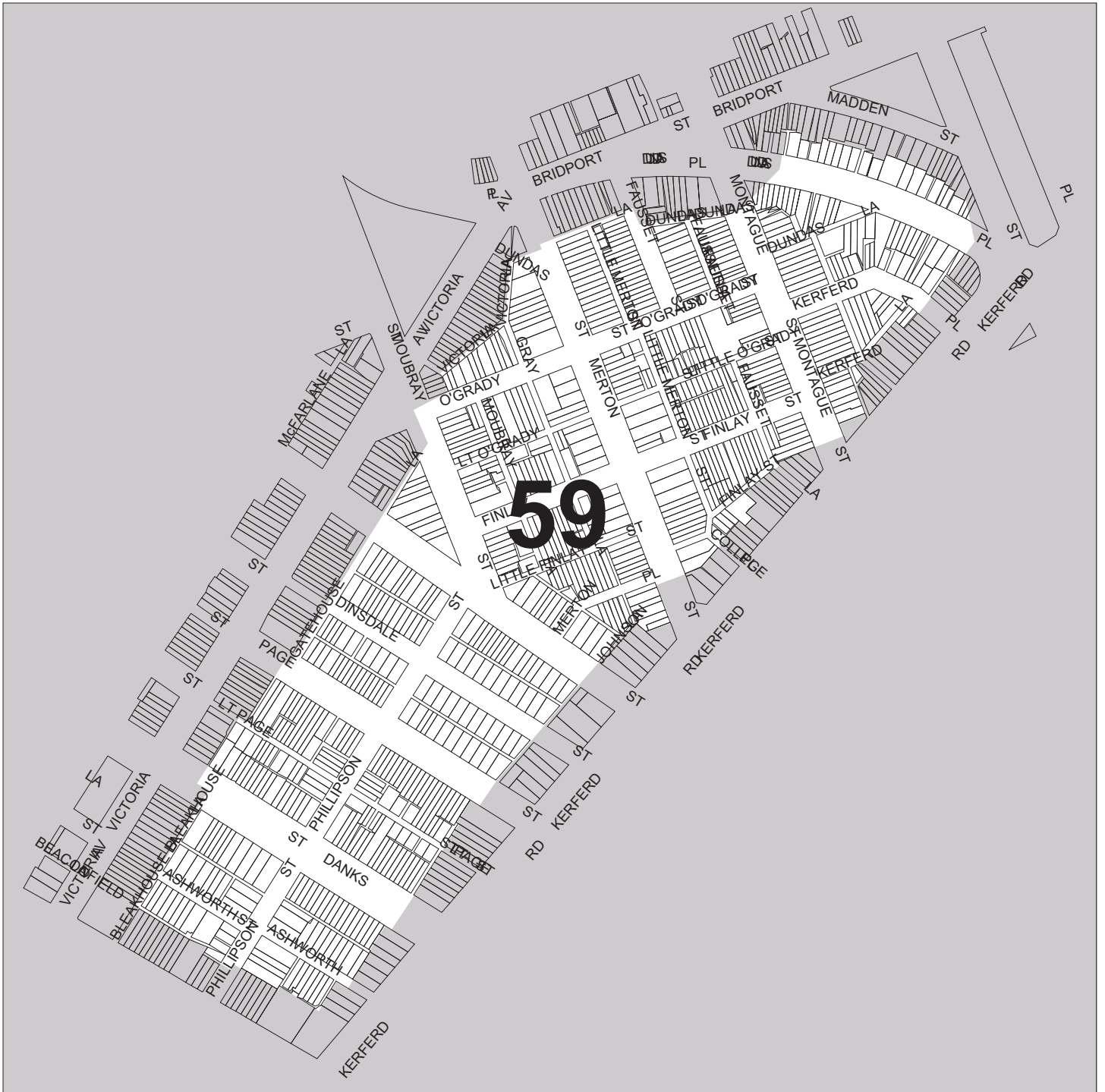

Dundas Pl, Kerford Rd, Victoria Ave, Beaconsfield Pde.

Streets in the area:

Ashworth St, Bleakhouse La, College Pl, Danks St, Dinsdale St, Dundas Pl, Faussett La, Finlay St, Gatehouse La, Gray La, Johnson La, Kerferd La, Kerferd Pl, Little Finlay St, Little Merton St, Little O'grady St, Little Page St, Merton Pl, Merton St, Montague La, Montague St, Moubray La, O'grady St, Page St, Philipson St, Richardson St,

Description of the character of the area:

The area is flat and streets vary from wide to narrow streets and laneways. The grid pattern shifts direction north of Richardson Street creating some angled intersections.

Lots are quite small throughout the area and the frontage width varies from narrow terraces to smaller double fronted houses. Setbacks also vary from buildings on property lines up to about five metres.

The area north of Richardson Street has a significant proportion of two storey houses and some three storey buildings, while the area south of Richardson Street is predominantly single storey.

The wider streets in the area tend to have fairly consistent larger scale Plane trees, with the exception of Danks Street which has a large median with Eucalypts. Small streets have very mixed plantings of a wide variety of species. Original kerbs and channels have been replaced with concrete through most of the area and many streets also have landscaped traffic management devices which detract from the consistency and heritage qualities of the area.

<i>Element</i>	<i>Description</i>
Dominant style	pre-1900s
Dominant scale	one and two storey
Dominant material	stucco and render/mixed
Dominant roof	pitched/metal
Setback	less than 5 metres/consistent
Heritage	entire area identified as heritage place
Gardens	visible/small
Fences	medium height/various materials

The existing urban character of the City of Port Phillip has been assessed using 24 character elements. The design should especially respond to the important and very important elements, which in this area are:

<i>Element</i>	<i>Importance</i>
Lot size	Important
Pattern	Important
Street dimensions	Important
Setbacks	Important
Building style	Important
Building scale	Important
Housing type	Important
Heritage	Important
Land use	Important
Access	Important
Foreshore	Important

A comprehensive urban character assessment and policy statement for the area is available from the Council .



City of Port Phillip
URBAN CHARACTER DESCRIPTION

AREA 60: VICTORIA AVENUE AND BRIDPORT STREET BETWEEN BEACONSFIELD PARADE AND FERRARS STREET

The following description should be used in carrying out the site analysis and design response to your site. Pay attention to the very important and important character elements listed here, as well as the actual conditions observed at the site analysis stage.

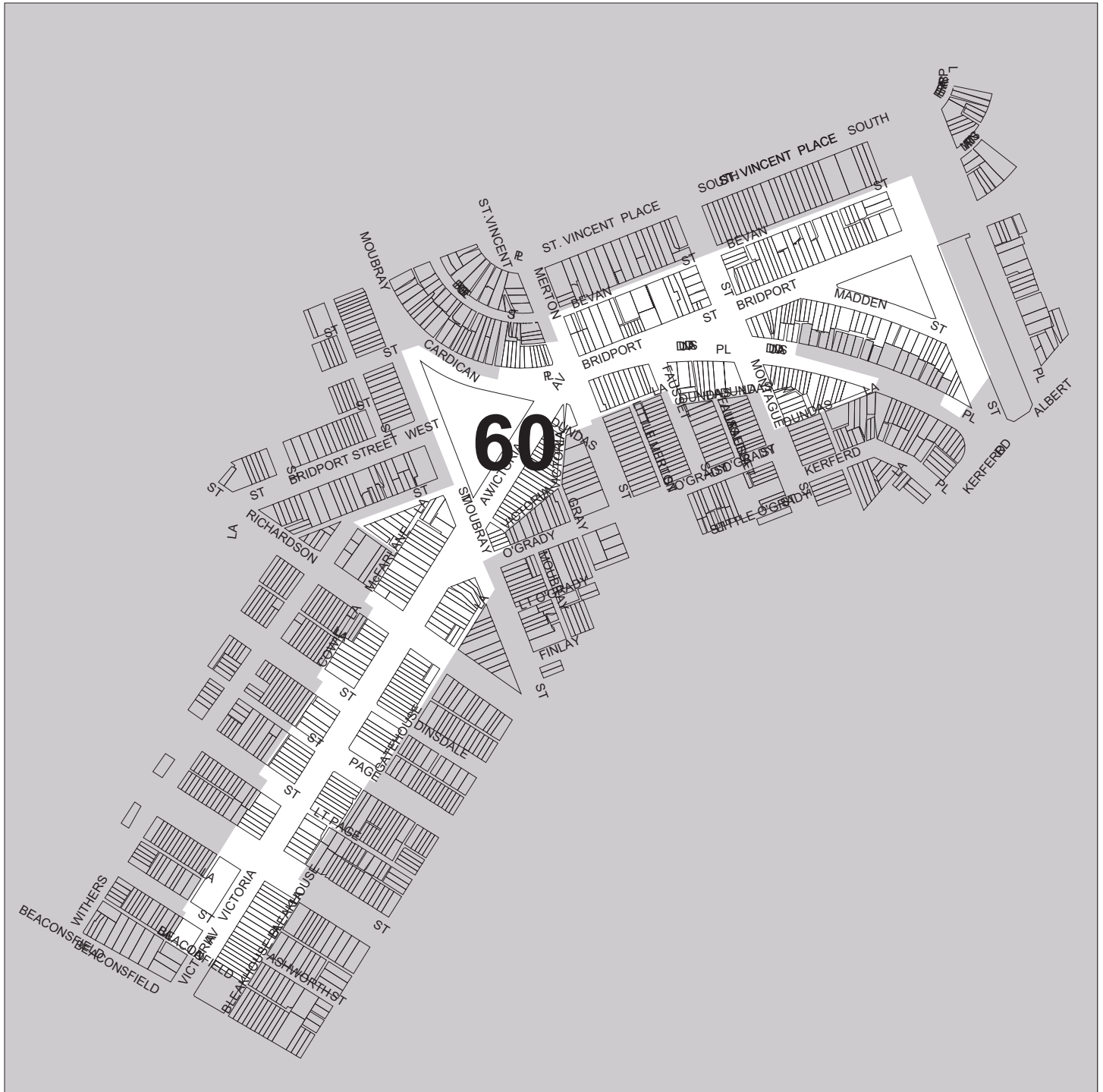

Boundary streets:

Victoria Ave, and Bridgeport St between Ferrars St, Beaconsfield Pde.

Streets in the area:

Bridport St, Danks St, Dinsdale St, Dundas La, Dundas Pl, Faussett St, Ferrars St, Gray La, Madden St, Mcfarlane La, Merton St, Montague La, Montague St, Moubray La, Moubray St, Richardson St, Victoria Av, Victoria La,

Description of the character of the area:

As the commercial and social focus for the Albert Park area, the area is distinguished from adjoining areas by its commercial land use and the presence of traffic and trams along its length.

It includes some residential properties mostly on the north side of Victoria Avenue and in Madden Street. These are usually Victorian and Edwardian terraces and detached houses with small setbacks and consistent front fences.

Bridport Street is the commercial heart of the area with shops, offices and restaurants on both frontages and a sense of place created by small triangular open spaces where angled streets intersect.

The area includes a range of street trees at various stages of development including some mature Elms near Moubray Street. Residential frontages also have median strips.

<i>Element</i>	<i>Description</i>
Dominant style	pre-1900s
Dominant scale	one and two storey
Dominant material	stucco and render/minor variation
Dominant roof	no dominance/metal
Setback	less than 5 metres/minor variation
Heritage	entire area identified as heritage place
Gardens	visible/small
Fences	buildings to property line

The existing urban character of the City of Port Phillip has been assessed using 24 character elements. The design should especially respond to the important and very important elements, which in this area are:

<i>Element</i>	<i>Importance</i>
Land use	Very important
Street dimensions	Important
Parking	Important
Footpaths	Important
Street detailing	Important
Fences	Important
Setbacks	Important
Building style	Important
Building scale	Important
Heritage	Important
Access	Important
Foreshore	Important

A comprehensive urban character assessment and policy statement for the area is available from the Council .



City of Port Phillip
URBAN CHARACTER DESCRIPTION

AREA 61: LAND GENERALLY BOUNDED BY PICKLES STREET, GREIG STREET, VICTORIA AVENUE AND BEACONSFIELD PARADE

The following description should be used in carrying out the site analysis and design response to your site. Pay attention to the very important and important character elements listed here, as well as the actual conditions observed at the site analysis stage.

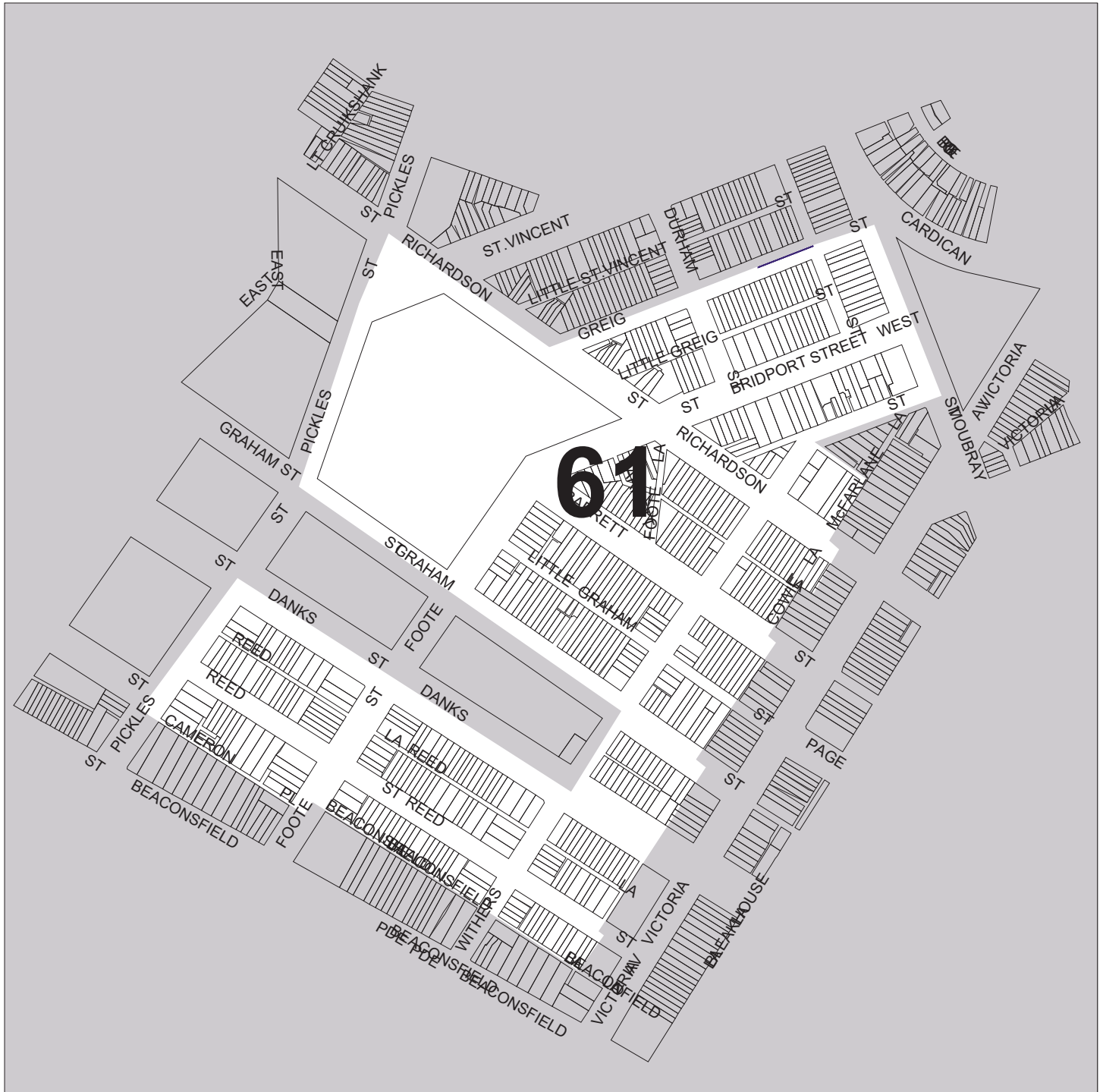

Boundary streets:

Reed St, Victoria Pde, Pickles St, Greig St, Moray St.

Streets in the area:

Barrett La, Barrett St, Bridport St West, Cowie La, Danks St, Foote La, Foote St, Graham St, Little Graham St, Little Greig St, Little Withers St, Moubray St, Pickles St, Reed La, Reed St, Richardson St, Withers St,

Description of the character of the area:

This area is characterised by small lots and small scale Victorian housing with narrow frontages and reduced setbacks. Many houses in the area are timber, either terraces or detached cottages.

Streets are quite varied in their dimensions with some wide streets, and a secondary system of small streets and a network of rear laneways. Original detailing in these streets has been replaced with simple concrete kerb and channel and only a few laneways retain original bluestone pavements and detailing.

Some streets have mature trees especially gums in Danks Street and Planes elsewhere, however the area has been subject to many planting fashions resulting in inconsistent and mixed planting in many streets.

The area is close to the foreshore and the Victoria Avenue commercial area.

<i>Element</i>	<i>Description</i>
Dominant style	pre-1900s
Dominant scale	one storey
Dominant material	timber or cladding/minor variation
Dominant roof	pitched/metal
Setback	less than 5 metres/consistent
Heritage	entire area identified as heritage place
Gardens	visible/small
Fences	medium height/varied materials

The existing urban character of the City of Port Phillip has been assessed using 24 character elements. The design should especially respond to the important and very important elements, which in this area are:

<i>Element</i>	<i>Importance</i>
Building scale	Very important
Lot size	Important
Street dimensions	Important
Fences	Important
Setbacks	Important
Building style	Important
Housing type	Important
Heritage	Important
Land use	Important
Foreshore	Important

A comprehensive urban character assessment and policy statement for the area is available from the Council .



City of Port Phillip
URBAN CHARACTER DESCRIPTION

AREA 62: LAND GENERALLY BOUNDED BY ROUSE STREET, PICKLES STREET, ESPLANADE WEST AND FOOT STREET, PORT MELBOURNE

The following description should be used in carrying out the site analysis and design response to your site. Pay attention to the very important and important character elements listed here, as well as the actual conditions observed at the site analysis stage.

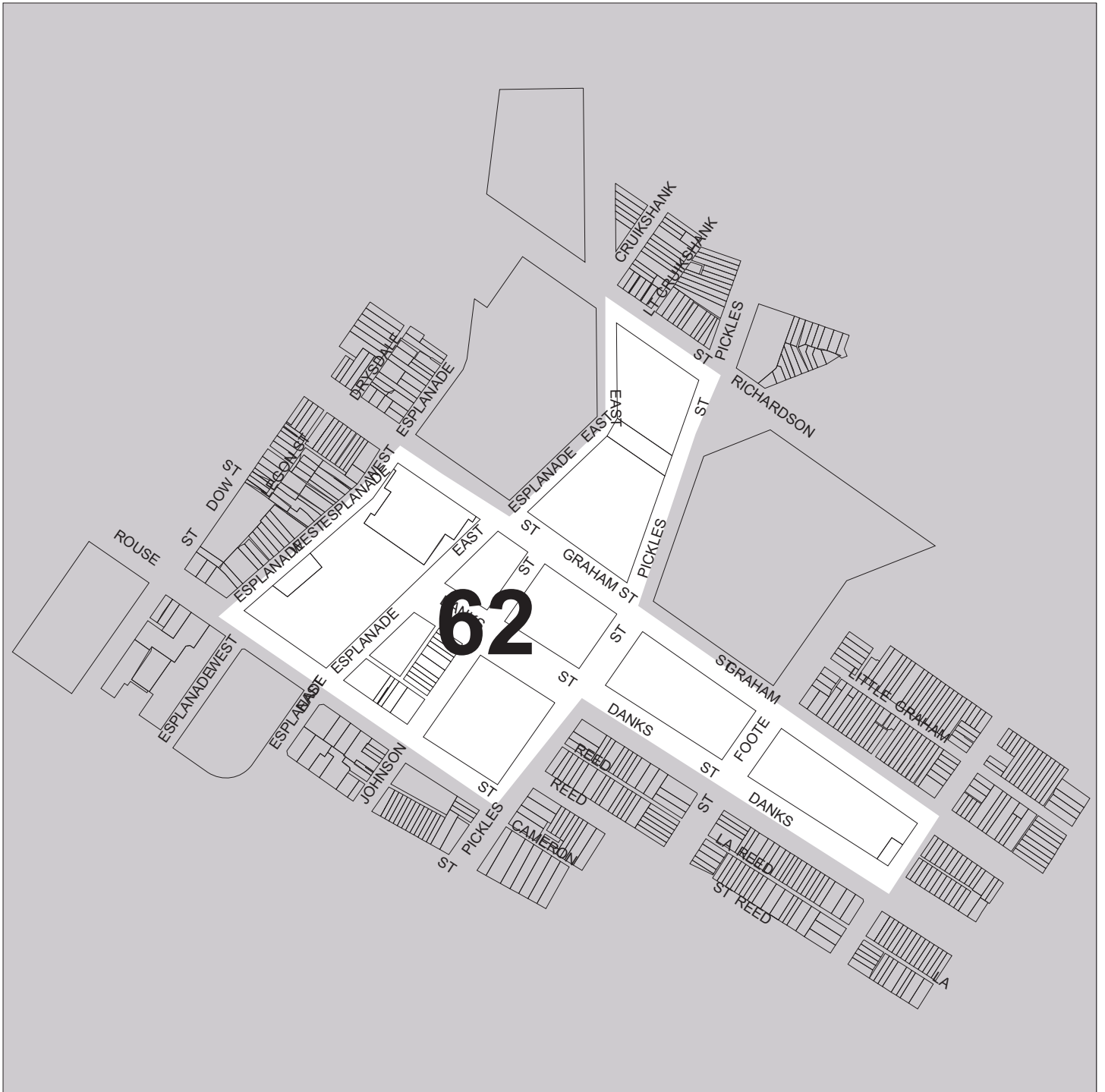

Boundary streets:

Liardet St, Whithers St, Rouse St, Esplanade West.

Streets in the area:

Danks St, Esplanade East, Graham St, Johnson St, Pickles St,

Description of the character of the area:

This area is differentiated from adjoining areas by the existence of many large undeveloped lots on the verge of transition from industrial uses to high density housing.

The scale of buildings in the area is also quite different because industrial and educational buildings are generally equivalent to three or four storey housing developments. Given these circumstances, the area includes one high quality public housing estate consisting of four stories.

Original street detailing has been replaced with concrete kerb and channel whilst footpaths are a mix of bitumen and concrete. Overhead services have a strong visual presence, partly because street trees are relatively inconsistent and inadequate.

<i>Element</i>	<i>Description</i>
Dominant style	1970s - 1990s
Dominant scale	one, two and three storey
Dominant material	brick or masonry/consistent
Dominant roof	pitched/metal
Setback	less than 5 metres/minor variation
Heritage	limited number of heritage places
Gardens	visible/small
Fences	various heights and materials

The existing urban character of the City of Port Phillip has been assessed using 24 character elements. The design should especially respond to the important and very important elements, which in this area are:

<i>Element</i>	<i>Importance</i>
Lot size	Very important
Pattern	Important
Building scale	Important
Land use	Important
Access	Important
Foreshore	Important

A comprehensive urban character assessment and policy statement for the area is available from the Council .



City of Port Phillip
URBAN CHARACTER DESCRIPTION

**AREA 63: BEACONSFIELD PARADE BETWEEN JOHNSON STREET AND KERFORD ROAD,
PORT MELBOURNE**

The following description should be used in carrying out the site analysis and design response to your site. Pay attention to the very important and important character elements listed here, as well as the actual conditions observed at the site analysis stage.

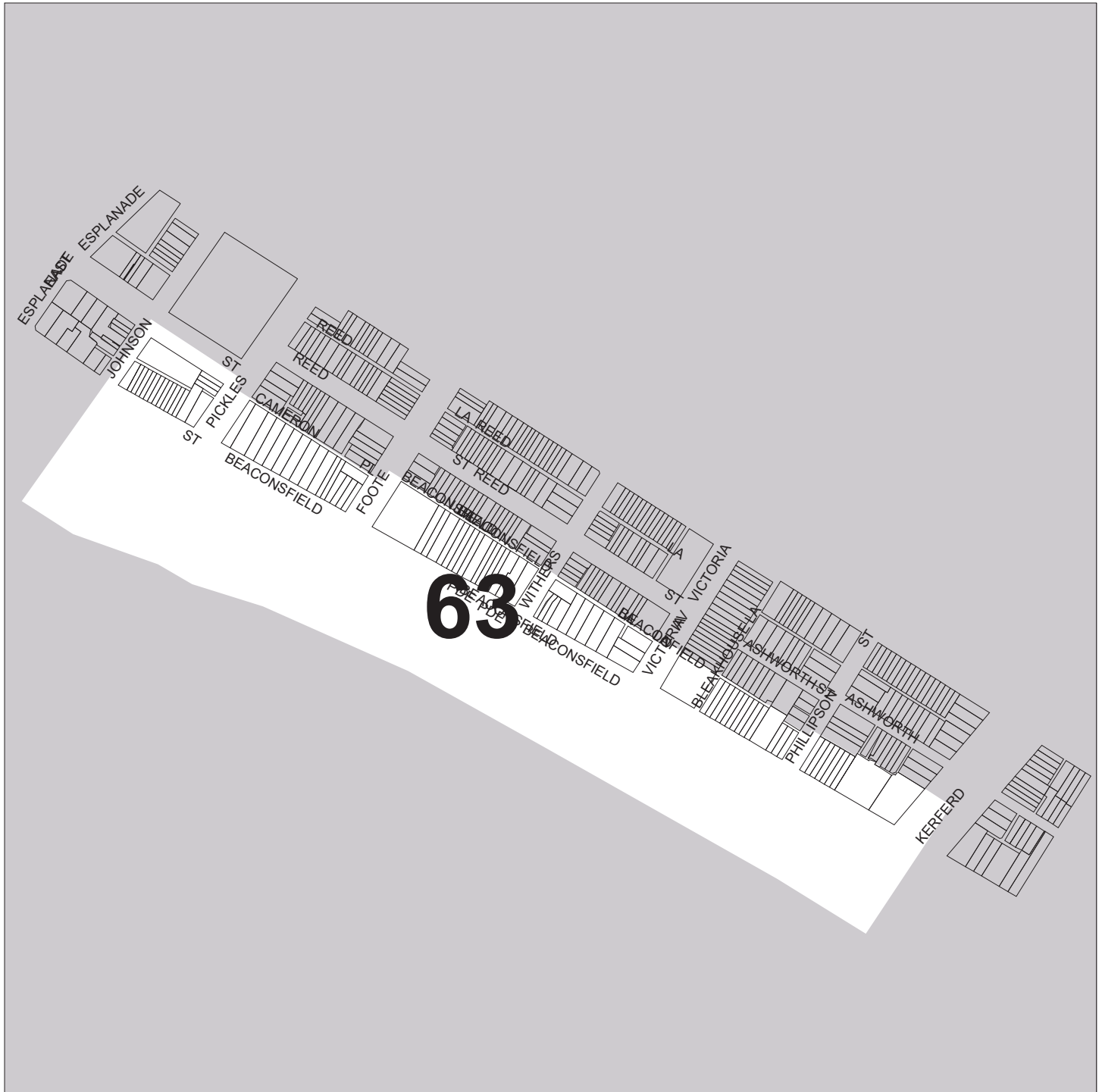

Boundary streets:

Beaconsfield Pde, Kerford Rd, Johnson St.

Streets in the area:

Beach St, Beaconsfield La, Beaconsfield Pde, Cameron Pl, Johnson St,

Description of the character of the area:

This area is distinguished from adjoining residential areas by its foreshore location with foreshore views and large scale buildings facing Beaconsfield Parade.

Housing in the area was originally developed in the Victorian period and many of the terraces, detached houses, commercial and institutional buildings still remain. Despite significant renovation and replacement with apartment buildings, new houses and a service station, the area retains its predominantly two storey scale and fairly consistent setback except at the northern end which is single storey.

Whilst Beaconsfield Parade is a wide and busy arterial road with associated traffic noise, the landscape character of palm trees which frame views to the water and the beach front promenade add to the character of the area.

These attributes combine to make the Albert Park foreshore a major tourist destination that generates significant on-street parking and tourist activity.

<i>Element</i>	<i>Description</i>
Dominant style	pre-1900s
Dominant scale	one and two storey
Dominant material	stucco and render/minor variation
Dominant roof	concealed by parapets/metal
Setback	less than 5 metres/minor variation
Heritage	@75% of identified heritage places
Gardens	visible/hidden/small
Fences	medium height/various materials

The existing urban character of the City of Port Phillip has been assessed using 24 character elements. The design should especially respond to the important and very important elements, which in this area are:

<i>Element</i>	<i>Importance</i>
Views	Very important
Street dimensions	Very important
Traffic	Very important
Street trees	Very important
Foreshore	Very important
Parking	Important
Footpaths	Important
Setbacks	Important
Building style	Important
Building scale	Important
Housing type	Important
Heritage	Important
Land use	Important
Access	Important

A comprehensive urban character assessment and policy statement for the area is available from the Council .



City of Port Phillip
URBAN CHARACTER DESCRIPTION

AREA 64: LAND GENERALLY BOUNDED BY LYONS STREET, SMITH STREET, RICHARDSON STREET AND ESPLANADE EAST AND WEST, PORT MELBOURNE

The following description should be used in carrying out the site analysis and design response to your site. Pay attention to the very important and important character elements listed here, as well as the actual conditions observed at the site analysis stage.

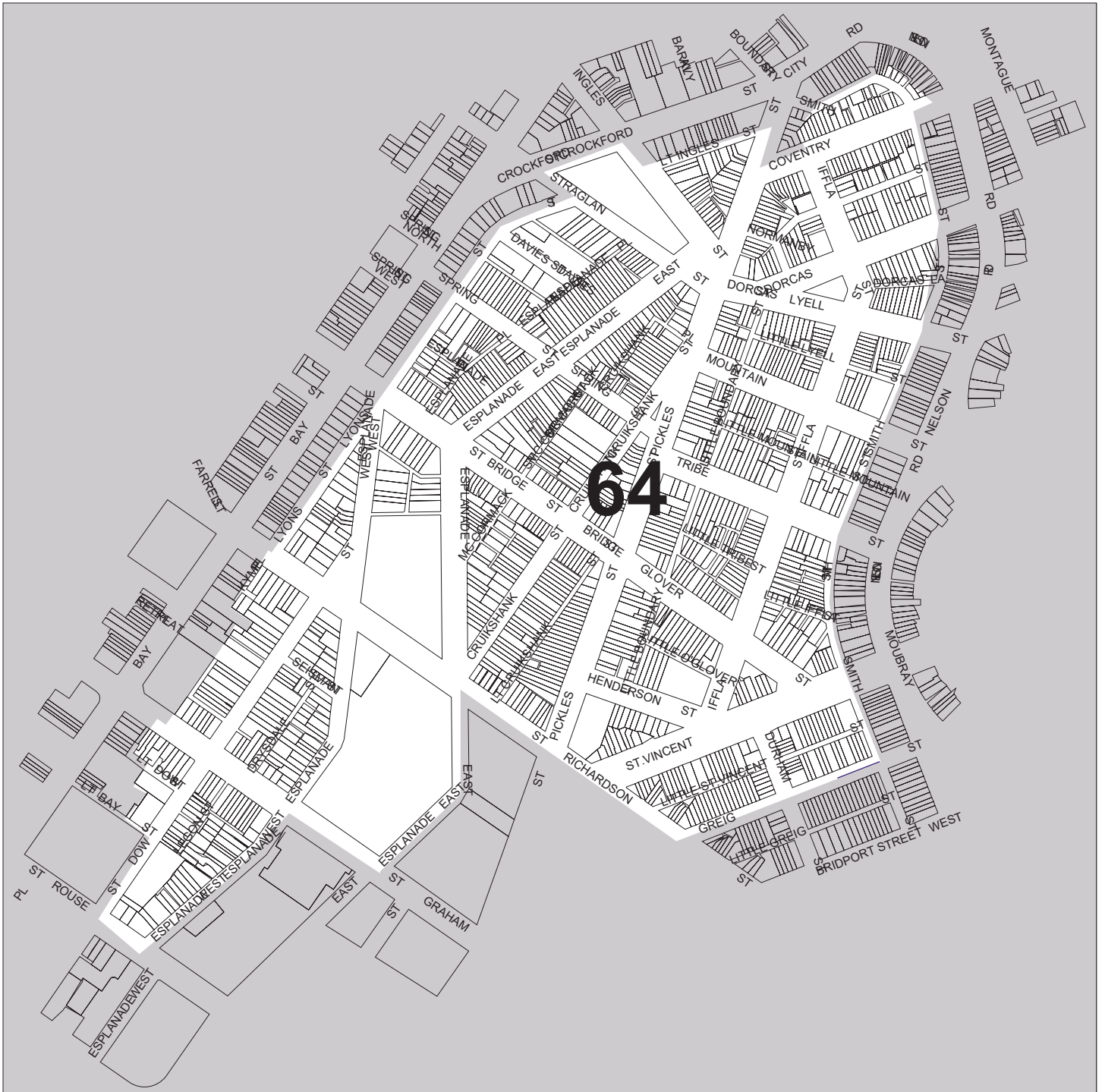

Boundary streets:

Bay St, Crockford St, Nelson Rd, St Vincents St, Esplanade West, Rouse St.

Streets in the area:

Bridge St, Bridge St, Coventry St, Cruikshank Pl, Cruikshank St, Davies St, Dorcas La, Dorcas St, Dow St, Drysdale St, Durham St, Esplanade East, Esplanade Pl, Esplanade West, Glover St, Graham St, Greig St, Henderson St, Iffla St, Ingles St, Kyme Pl, Liardet St, Little Boundary St, Little Cruikshank St, Little Glover St, Little Iffla St, Little Lyell St, Little Mountain St, Little St Vincent St, Little Tribe St, Lyell St, Lyons St, McCormack St, Mountain St, Normanby St, Pickles St, Raglan St, Seisman St, Smith St, Smith St, Spring St East, St Vincent St, Tribe St, Lagoon La, Mclarty La,

Description of the character of the area:

The area is characterised by consistently small, narrow lots with small scale housing mostly from the Victorian period behind reduced set backs. Also, many of the terraces and detached cottages are constructed in timber.

The area also includes a proportion of new infill development consisting of two storey brick dwellings and walk-up public housing blocks in Ingles Street.

Streets are quite varied in their dimensions with some wide streets, a secondary system of small streets and a network of rear laneways. Original detailing in these streets has been largely replaced with simple concrete kerb and channel and only a few laneways retain original bluestone pavements and detailing.

Some streets have mature trees, however, the area has been subject to many planting fashions resulting in inconsistent and mixed planting. Street trees in the old Port Melbourne part of the area are generally of poorer quality with more mixed species.

<i>Element</i>	<i>Description</i>
Dominant style	pre-1900s
Dominant scale	one storey
Dominant material	timber or cladding/minor variation
Dominant roof	pitched/metal
Setback	less than 5 metres/consistent
Heritage	@90% identified heritage places
Gardens	visible/small
Fences	medium height/various materials

The existing urban character of the City of Port Phillip has been assessed using 24 character elements. The design should especially respond to the important and very important elements, which in this area are:

<i>Element</i>	<i>Importance</i>
Lot size	Very important
Building scale	Very important
Pattern	Important
Fences	Important
Setbacks	Important
Building style	Important
Housing type	Important
Heritage	Important

A comprehensive urban character assessment and policy statement for the area is available from the Council .



City of Port Phillip
URBAN CHARACTER DESCRIPTION

AREA 65: LAND GENERALLY BOUNDED BY YORK STREET, FERRARS STREET, DRAPER STREET AND NELSON ROAD, PORT MELBOURNE

The following description should be used in carrying out the site analysis and design response to your site. Pay attention to the very important and important character elements listed here, as well as the actual conditions observed at the site analysis stage.

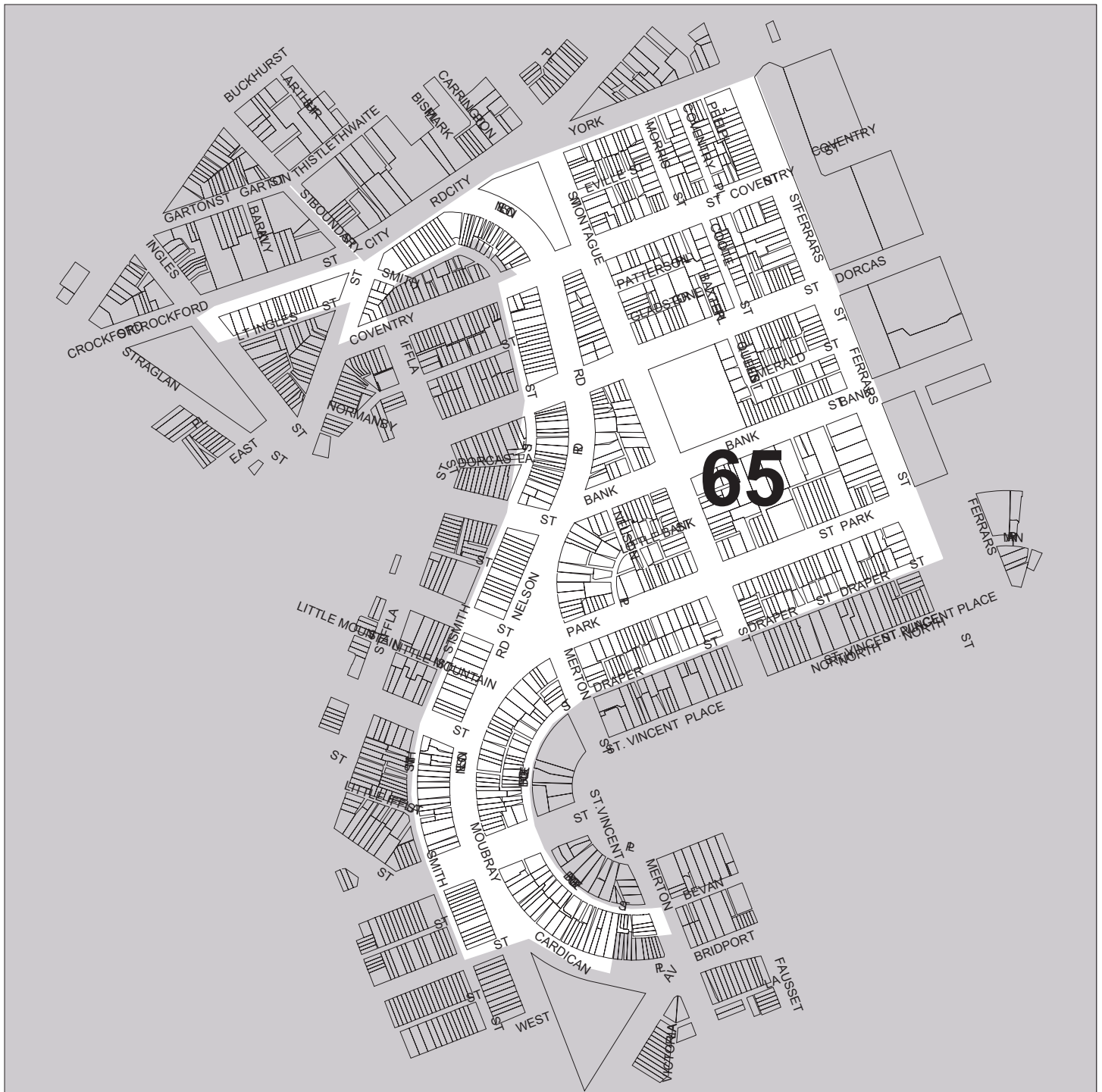

Boundary streets:

Ferrars St, Draper St, York St, Smith St.

Streets in the area:

Bank St, Baxter Pl, Brooke St South, Cardigan Pl, Coote St, Coventry Pl, Coventry St, Dorcas St, Draper St, Emerald St, Eville St, Ferrars St, Gladstone Gv, Little Ingles St, Merton St, Montague St, Morris St, Moubray St, Nelson Pl, Nelson Rd, Park St, Patterson Pl, Pickles St, Queen St, Smith St,

Description of the character of the area:

This area is bounded by the light rail line to the east, industrial uses to the north, St Vincent Place to the south and similar residential areas to the west. It differs from the area to the west because of the steeper landform, sloping to the north and west, and more variety in land use and building scale. The area also retains more of its original street detailing.

It has a regular grid pattern of wide streets and an overlaying pattern of narrow small scale streets. The western edge of this grid is formed by the curvilinear Nelson Road creating unusual intersections and taped allotments.

The area was substantially developed during the Victorian period and includes some significant institutional buildings and a number of corner hotels. A limited amount of redevelopment in subsequent periods includes multi-unit housing in the post-war period.

Street trees are present in all but the narrowest of streets however the area has been subject to numerous planting fashions with remnants of each style remaining in many streets.

<i>Element</i>	<i>Description</i>
Dominant style	pre-1900s
Dominant scale	one and two storey
Dominant material	stucco and render/mixed
Dominant roof	pitched/metal
Setback	less than 5 metres/minor variation
Heritage	entire area identified as heritage place
Gardens	visible/small
Fences	medium height/various materials

The existing urban character of the City of Port Phillip has been assessed using 24 character elements. The design should especially respond to the important and very important elements, which in this area are:

<i>Element</i>	<i>Importance</i>
Building style	Very important
Lot size	Important
Street dimensions	Important
Street detailing	Important
Fences	Important
Setbacks	Important
Building scale	Important
Heritage	Important
Access	Important

A comprehensive urban character assessment and policy statement for the area is available from the Council .



City of Port Phillip
URBAN CHARACTER DESCRIPTION

AREA 66: ST VINCENTS PLACE

The following description should be used in carrying out the site analysis and design response to your site. Pay attention to the very important and important character elements listed here, as well as the actual conditions observed at the site analysis stage.

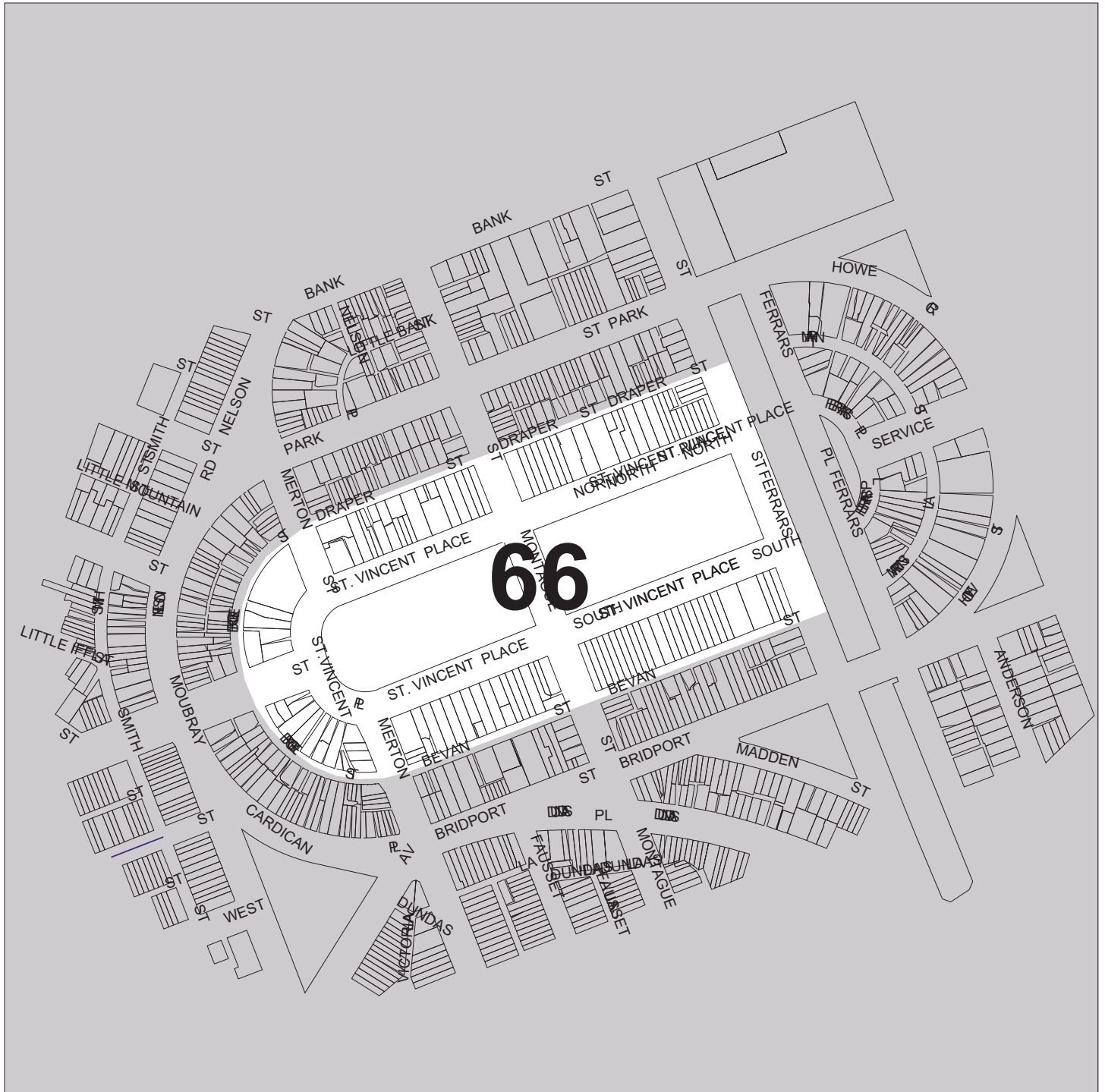

Boundary streets:

Ferrars St, Draper St, Bevan St, Brooke St.

Streets in the area:

Bevan St, Brooke St North, Ferrars St, Merton St, Montague St, St Vincent PI North, St Vincent PI South, St Vincent St,

Description of the character of the area:

This area includes housing which faces St Vincent Gardens and it is distinct from adjoining areas because of the subdivision design around the gardens and the larger scale of Victorian dwellings.

The area has especially high heritage value due to the presence of the gardens, the consistent residential style and the original street detailing.

Front fences, front gardens and generous street dimensions are also important contributors to the character of the area.

<i>Element</i>	<i>Description</i>
Dominant style	pre-1900s
Dominant scale	two storey
Dominant material	stucco and render/consistent
Dominant roof	concealed by parapet/slate
Setback	5-9 metres/minor variation
Heritage	entire area identified as heritage place
Gardens	visible/medium/small
Fences	medium height/consistent

The existing urban character of the City of Port Phillip has been assessed using 24 character elements. The design should especially respond to the important and very important elements, which in this area are:

<i>Element</i>	<i>Importance</i>
Pattern	Very important
Building style	Very important
Heritage	Very important
Open space	Very important
Views	Important
Street dimensions	Important
Street trees	Important
Street detailing	Important
Fences	Important
Front gardens	Important
Building scale	Important
Land use	Important
Access	Important

A comprehensive urban character assessment and policy statement for the area is available from the Council .



City of Port Phillip
URBAN CHARACTER DESCRIPTION

AREA 67: ALBERT PARK

The following description should be used in carrying out the site analysis and design response to your site. Pay attention to the very important and important character elements listed here, as well as the actual conditions observed at the site analysis stage.

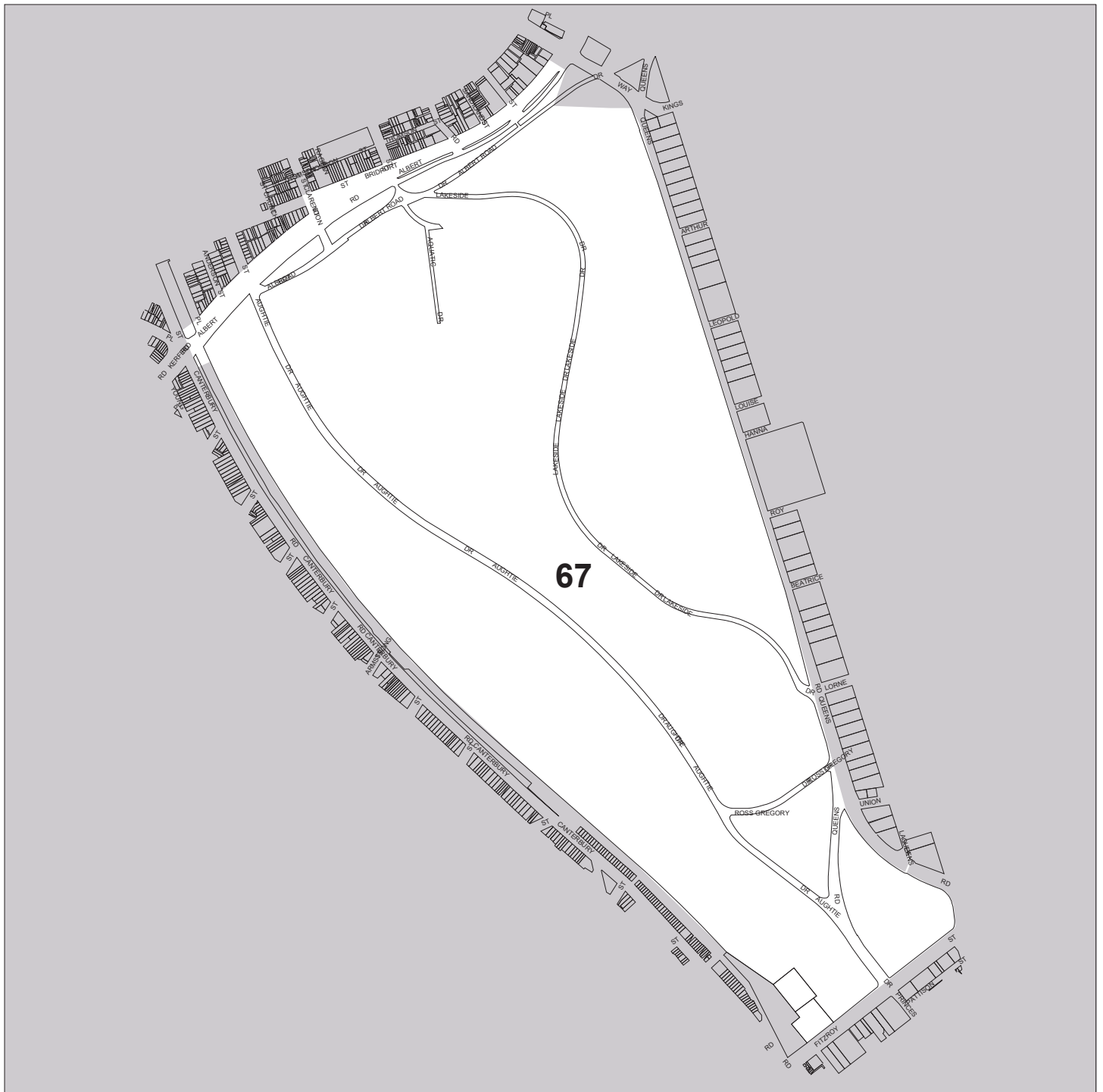

Boundary streets:

Canterbury Rd, Fitzroy St, Queens Rd, Albert Rd.

Streets in the area:

Albert Rd, Queens Rd,

Description of the character of the area:

With the lake as the central focus, the park is an important recreation resource for surrounding residential areas and attracts more visitors than any other park in Melbourne.

It has an internal road system that provides access to numerous sporting facilities for both active and passive recreation and other institutional buildings used for education purposes.

The park has recently been redeveloped to accommodate the Melbourne Grand Prix with the park roads becoming a car racing circuit. During this period, approximately one month of each year, many temporary structures and facilities occupy the park.

The open nature of the park means that skyline views of city and St Kilda Road buildings are ever present. While the park has listed heritage status, modern buildings and landscape dominate the parks character over conventional heritage values.

<i>Element</i>	<i>Description</i>
Dominant style	pre-1900s
Dominant scale	two storey
Dominant material	timber or cladding/mixed
Dominant roof	flat/metal
Setback	Variable
Heritage	entire area identified as heritage place
Gardens	(no private domain)
Fences	(no private domain)

The existing urban character of the City of Port Phillip has been assessed using 24 character elements. The design should especially respond to the important and very important elements, which in this area are:

<i>Element</i>	<i>Importance</i>
Lot size	Very important
Signage	Very important
Open space	Very important
Views	Important
Traffic	Important
Building style	Important
Land use	Important

A comprehensive urban character assessment and policy statement for the area is available from the Council .



City of Port Phillip
URBAN CHARACTER DESCRIPTION

AREA 68: LAND GENERALLY BOUNDED BY ALBERT ROAD, MORAY STREET, RAGLAN STREET AND KINGSWAY, SOUTH MELBOURNE

The following description should be used in carrying out the site analysis and design response to your site. Pay attention to the very important and important character elements listed here, as well as the actual conditions observed at the site analysis stage.

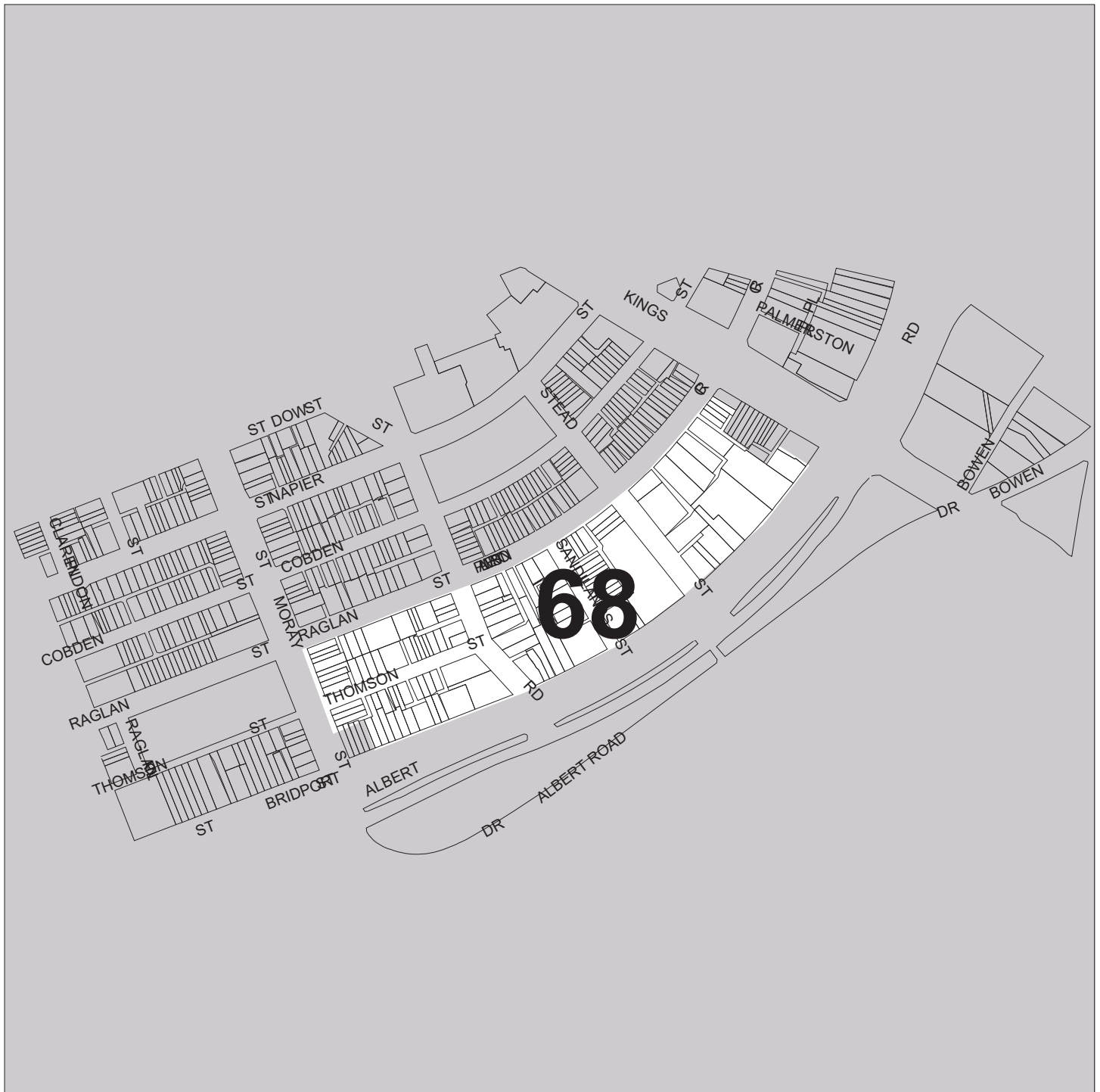

Boundary streets:

Albert Rd, Moray St, Palmerston St, Kings Way.

Streets in the area:

Sandilands St, Stead St, Thomson St,

Description of the character of the area:

This area is distinguished from adjoining areas to the north by its commercial land use and relatively large building scale. It is an extension of office development in St Kilda Road and Kings Way. The area has a mixed lot size with larger lots facing Albert Road, however, many of the original small lots have been amalgamated to create larger commercial sites.

The area retains little of its pre-war buildings with most being replaced during the 60's - 90's with office buildings of varied design, materials and scale. Many buildings are three storeys or more, with taller buildings closer to Kings Way overlooking Albert Road.

Most of the original street detailing has also been replaced in recent decades however the area retains consistent bitumen footpaths throughout.

The office use generates significant on-street parking despite the fact that most buildings have on-site car parks. Signage on buildings is generally quite discrete.

The area has good access to public transport and open space but is more distant from the core shopping and community area in Clarendon Street.

<i>Element</i>	<i>Description</i>
Dominant style	1970s -1990s
Dominant scale	more than 3 stories
Dominant material	mixed
Dominant roof	concealed by parapets/metal
Setback	less than 5 metres/minor variation
Heritage	no identified heritage places
Gardens	visible/small
Fences	no fences

The existing urban character of the City of Port Phillip has been assessed using 24 character elements. The design should especially respond to the important and very important elements, which in this area are:

<i>Element</i>	<i>Importance</i>
Building scale	Very important
Lot size	Important
Parking	Important
Building style	Important
Land use	Important
Access	Important
Open space	Important

A comprehensive urban character assessment and policy statement for the area is available from the Council .

Boundary streets:

Palmerston St, Kings Way, Banks St, Moray St, Coventry St, Clarendon St, Bridgeport St.

Streets in the area:

Bank Pl, Bank St, Clarendon Pl, Cobden St, Dorcas St, Dow St, Eastern Rd, Fitzpatrick St, Heather St, Law St, Moray St, Napier St, Palmer St, Palmerston Cr, Park St, Raglan St, Stead St, Thomson St, Union Pl, Wilson St,

Description of the character of the area:

The area has been subdivided into a grid of wide and narrow streets with a rich pattern of lane ways. The original pattern of streets has been modified with closures, one way streets and road narrowing to restrict through traffic to larger arterial roads.

Whilst most of the area has been developed with small lots and terraced housing constructed during the Victorian period, the area has undergone some redevelopment in the post-war period with several larger allotments being redeveloped with public and private medium and high density housing.

Much of the original bluestone kerb and channel and road geometry has been lost, however, the area retains consistent bitumen footpaths throughout. Car parking in the streets is visually dominant and overhead services also have some impact. Street trees have been introduced to most streets, but tend to be inconsistent in species and scale.

The area is ideally located in relation to shops open space and public transport. It also has a range of public facilities.

<i>Element</i>	<i>Description</i>
Dominant style	pre-1900s
Dominant scale	one and two storey
Dominant material	timber or cladding/mixed
Dominant roof	pitched/metal
Setback	less than 5 metres/minor variation
Heritage	@75% identified as heritage place
Gardens	visible/small
Fences	medium height/various materials

The existing urban character of the City of Port Phillip has been assessed using 24 character elements. The design should especially respond to the important and very important elements, which in this area are:

<i>Element</i>	<i>Importance</i>
Building style	Very important
Building scale	Very important
Parking	Important
Fences	Important
Setbacks	Important
Housing type	Important
Heritage	Important
Access	Important

A comprehensive urban character assessment and policy statement for the area is available from the Council .



City of Port Phillip
URBAN CHARACTER DESCRIPTION

AREA 70: LAND GENERALLY BOUNDED BY ALBERT ROAD, FERRARS STREET, COVENTRY STREET AND CLARENDON STREET, SOUTH MELBOURNE

The following description should be used in carrying out the site analysis and design response to your site. Pay attention to the very important and important character elements listed here, as well as the actual conditions observed at the site analysis stage.

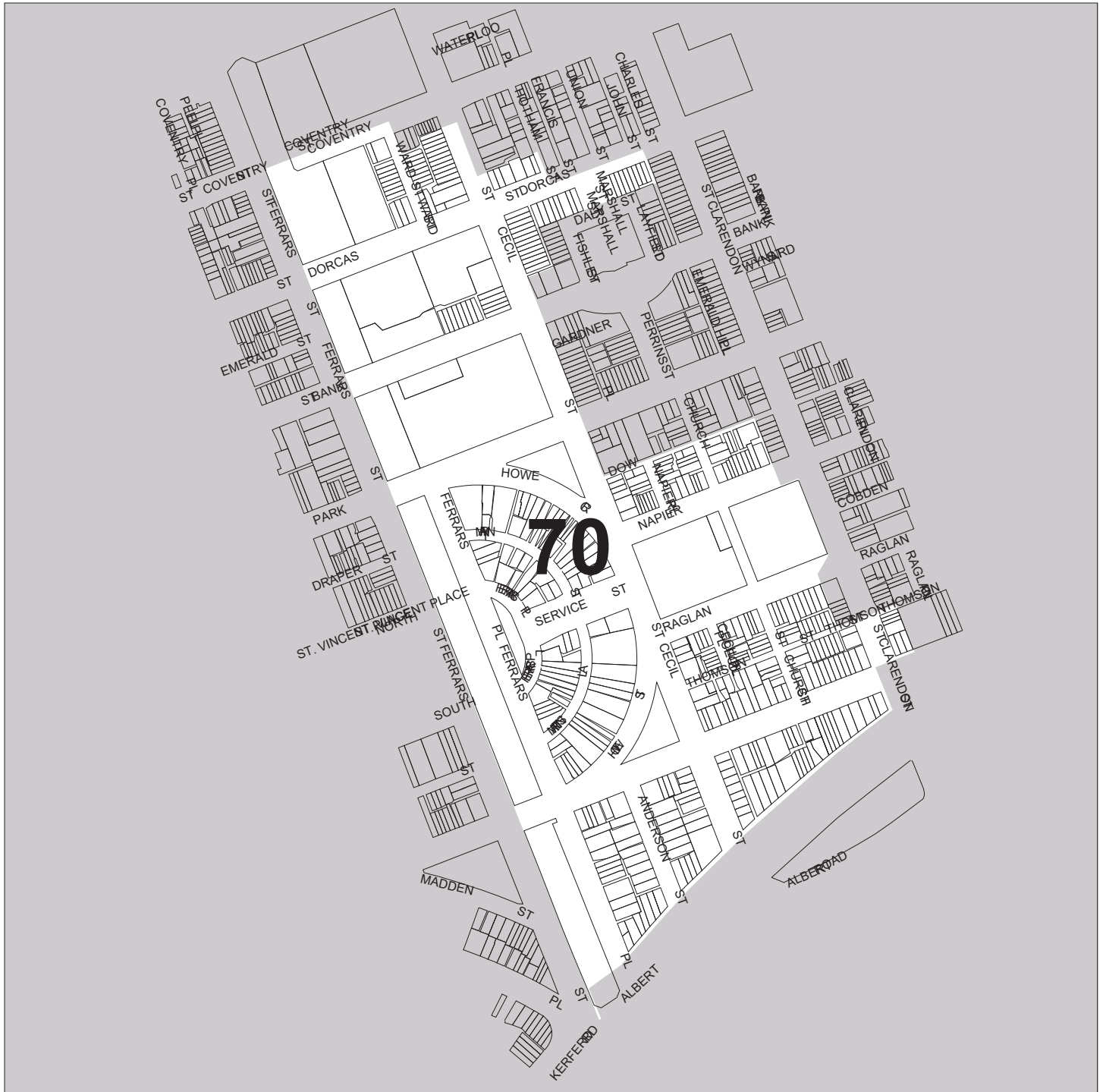

Boundary streets:

Light rail, Albert Rd, Clarendon St, Cecil St, Coventry St.

Streets in the area:

Anderson St, Bank St, Bridport St, Cecil Pl, Cecil St, Church St, Clarendon St, Dorcas St, Emerald Hill Pl, Ferrars Pl, Fishley St, Howe Cr, James Service Pl, Layfield St, Marshall St, Martin St, Napier St, Park St, Raglan St, Thomson St, Ward St, Ferrars Pl,

Description of the character of the area:

The area has a formal subdivision pattern including the unusual curved streets of Howe Crescent and Ferrars Place. Many streets are wide, but there is an additional overlay of much smaller streets and lanes. Lot sizes and frontage width in the area are extremely varied although the greatest number of lots are less than 300 square metres.

The area was originally developed during the Victorian period and many houses and public buildings remain from this period. The area has also undergone redevelopment for private and public housing with the Park Towers estate on Park Street now a dominant building in the area. Larger institutional sites like the St Vincent Boys Home and Uniting Church site have been sub divided during the post-war period for multi-unit housing.

Streets in the area have been substantially modified with a range of bizarre traffic management devices and as a consequence, Victorian detailing is limited. Many roads have collector or arterial status and carry quite heavy volumes of through traffic whilst many others have been closed or made one way. Street trees are extremely mixed and do not reflect the grand proportions of many of the streets. The area has excellent accessibility.

<i>Element</i>	<i>Description</i>
Dominant style	pre-1900s
Dominant scale	one and two storey
Dominant material	stucco and render/minor variation
Dominant roof	pitched/metal
Setback	less than 5 metres
Heritage	entire area identified as heritage place
Gardens	visible/small
Fences	medium height/various materials

The existing urban character of the City of Port Phillip has been assessed using 24 character elements. The design should especially respond to the important and very important elements, which in this area are:

<i>Element</i>	<i>Importance</i>
Building style	Very important
Access	Very important
Lot size	Important
Pattern	Important
Street dimensions	Important
Traffic	Important
Parking	Important
Fences	Important
Building scale	Important
Housing type	Important
Heritage	Important
Open space	Important

A comprehensive urban character assessment and policy statement for the area is available from the Council .

Boundary streets:

Clarendon St between Grant St and Thompson St, Park St to Cecil St and Coventry St to Ferrars St.

Streets in the area:

South Melbourne Mark, Alfred Pl, Bank Pl, Cecil St, Charles St, Church St, Clarendon St, Coventry St, Dorcas St, Dow St, Francis St, Hotham St, John St, Napier Pl, Palmer St, Park St, Raglan Pl, Ross Pl, Union St, Wynyard St, Yarra Pl,

Description of the character of the area:

The character of the area is primarily determined by its mixed land use dominated by shopping. The wide streets of Clarendon, Coventry and Park Streets are important contributing factors, although the area also includes many little streets and lane ways. The heart of the shopping area is in Clarendon Street between Park and Coventry Streets where there are extensive verandahs and limited street trees.

The area south of Coventry Street has fairly consistent streetscapes that retain a high percentage of Victorian and inter-war buildings although there has also been significant development in the post-war period. The Coles supermarket and car park is perhaps the best example of inappropriate post-war development with an entire block in the heart of the shopping centre dedicated to an ugly car park.

The area has good views to the north towards the city skyline and is very accessible by public transport with tram lines along Clarendon and Park Streets. Over head services and commercial signage are visually prominent in the area. The area retains much of its original bluestone and bitumen street detailing, however some sections have been lost and there are some awkward additions of new street widenings and planter beds at intersections.

<i>Element</i>	<i>Description</i>
Dominant style	pre-1900s
Dominant scale	two storey
Dominant material	stucco and render/minor variation
Dominant roof	concealed by parapet/metal
Setback	less than 5 metres/minor variation
Heritage	more than 50% identified as heritage place
Gardens	invisible
Fences	buildings to property line

The existing urban character of the City of Port Phillip has been assessed using 24 character elements. The design should especially respond to the important and very important elements, which in this area are:

<i>Element</i>	<i>Importance</i>
Land use	Very important
Views	Important
Street dimensions	Important
Traffic	Important
Parking	Important
Footpaths	Important
Overhead services	Important
Signage	Important
Fences	Important
Setbacks	Important
Building style	Important
Building scale	Important
Heritage	Important
Access	Important

A comprehensive urban character assessment and policy statement for the area is available from the Council .



City of Port Phillip
URBAN CHARACTER DESCRIPTION

**AREA 72: DALY STREET, LAYFIELD STREET, FISHLEY STREET AND PERRINS STREET,
SOUTH MELBOURNE**

The following description should be used in carrying out the site analysis and design response to your site.
Pay attention to the very important and important character elements listed here, as well as the actual conditions observed at the site analysis stage.

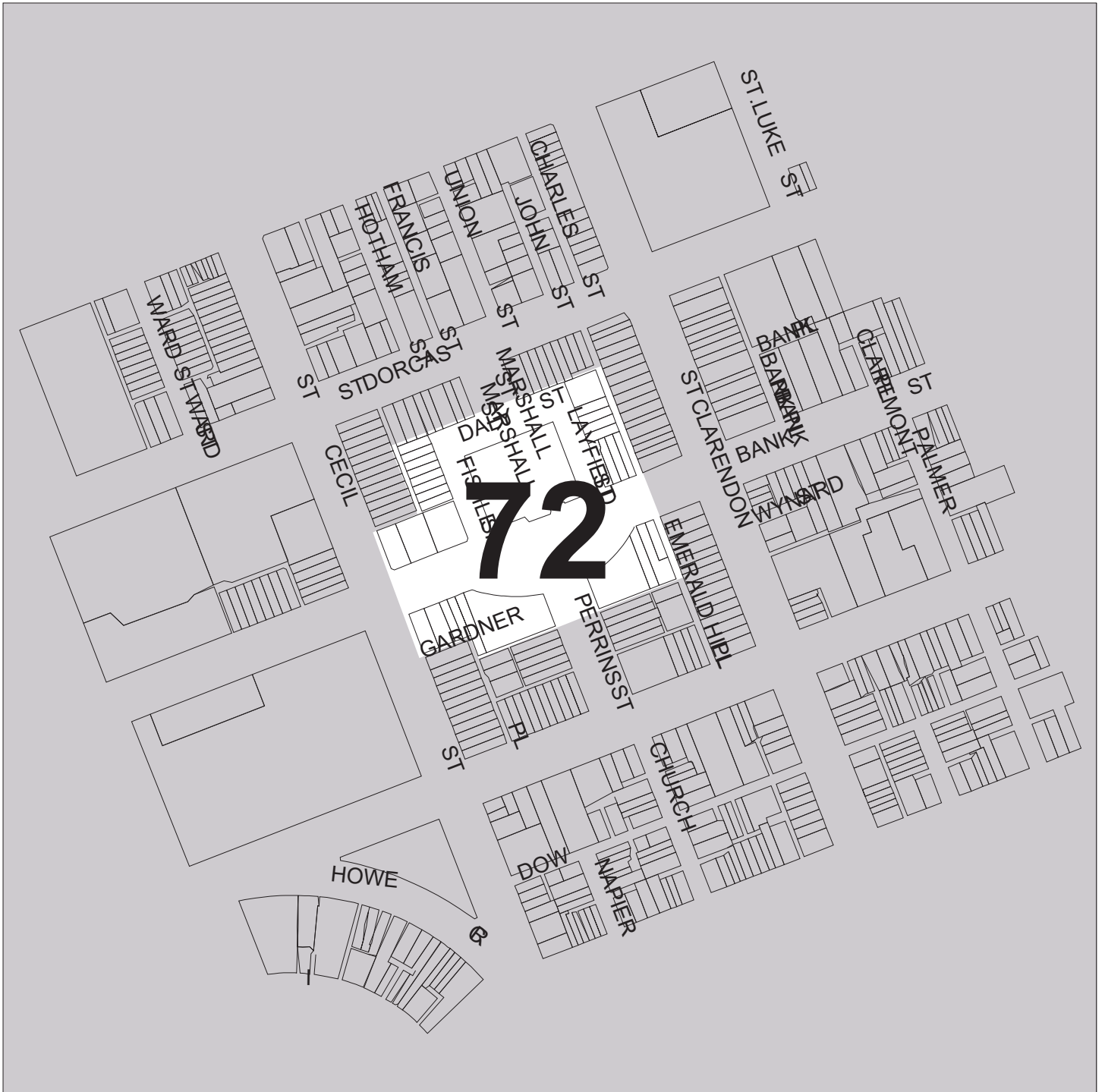

Boundary streets:

Daly St, Layfield St, Fishley St, Perrins St.

Streets in the area:

Bank St, Daly St, Emerald Hill Pl, Perrins St,

Description of the character of the area:

This area is distinct from adjoining areas because of its formal plan layout and the presence of carefully grouped public buildings and rich mix of uses within a very small precinct.

Occupying the high point of Emerald Hill, it is dominated by the South Melbourne Town Hall as the central focus surrounded by the post office and court house as well as an interesting combination of shops, offices and housing.

Banks and Perrins Streets are wide with Bank Street curving outside the Town Hall to create a small green space. The area retains most of its original street detailing and is overlaid by more recent landscaping and street trees.

Building scale in the area is subservient to the Town Hall yet large enough to enclose street spaces. The careful modulation of building scale is very important to the character of the area.

The area has excellent access to public facilities, shops and public transport and includes some limited open space.

<i>Element</i>	<i>Description</i>
Dominant style	pre-1900s
Dominant scale	one and two storey
Dominant material	stucco and render/minor variation
Dominant roof	concealed by parapet/metal
Setback	less than 5 metres/minor variation
Heritage	entire area identified as heritage place
Gardens	visible/small
Fences	medium/ building to property line/various materials

The existing urban character of the City of Port Phillip has been assessed using 24 character elements. The design should especially respond to the important and very important elements, which in this area are:

<i>Element</i>	<i>Importance</i>
Pattern	Very important
Building scale	Very important
Heritage	Very important
Access	Very important
Landform	Important
Views	Important
Lot size	Important
Street dimensions	Important
Parking	Important
Street detailing	Important
Setbacks	Important
Building style	Important
Land use	Important

A comprehensive urban character assessment and policy statement for the area is available from the Council .



City of Port Phillip
URBAN CHARACTER DESCRIPTION

AREA 73: MORAY STREET BETWEEN WESTGATE FREEWAY AND BANK STREET, SOUTH MELBOURNE

The following description should be used in carrying out the site analysis and design response to your site. Pay attention to the very important and important character elements listed here, as well as the actual conditions observed at the site analysis stage.

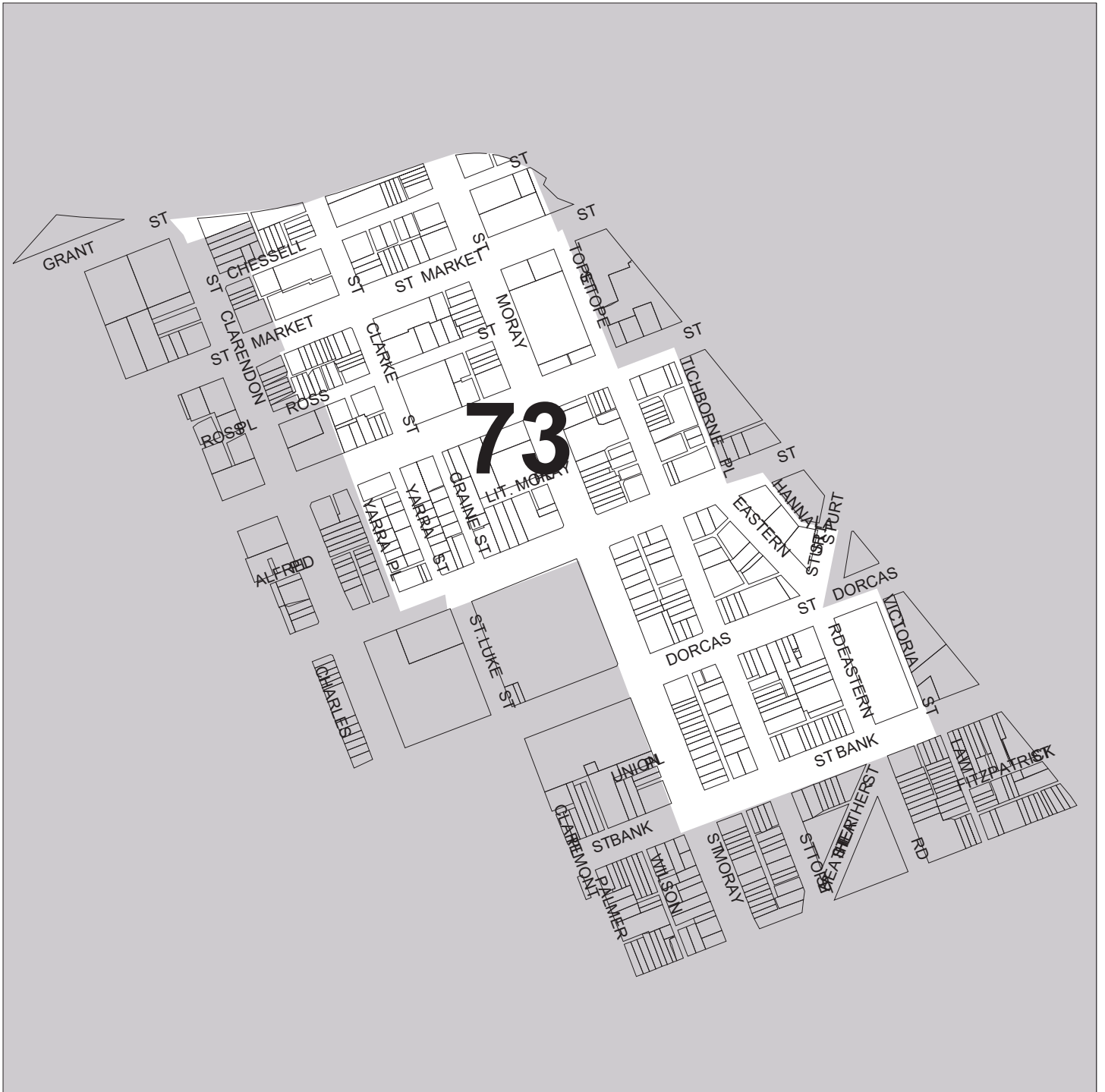

Boundary streets:

West Gate Freeway, Clarendon St, Kings Way, Bank St, Moray St, Coventry St.

Streets in the area:

Bank St, Chessell St, Clarke St, Coventry St, Craine St, Dorcas St, Eastern Rd, Little Moray Pl, Market St, Moray St, Ross St, Tichborne Pl, Tope St, Victoria St, York St,

Description of the character of the area:

Providing services to the city, the area is distinguished from adjoining areas primarily by its industrial and commercial land uses including many printing, car repair, warehousing, building supplies and some office uses.

The area has an almost pure grid of streets and lanes of widely varying dimensions. It has been partially developed with terrace housing, however most of these smaller sites with narrow frontages appear to have been amalgamated and developed for factory and offices uses.

With few residences remaining in the area, buildings have been constructed during the post-war period with no setback and a height variation of one to three storeys. Most are crude commercial buildings and there is little consistency in materials, proportions or signage.

Streets in the area retain elements of original street detailing and there is fairly consistent bitumen footpaths throughout although they are often broken by concrete crossovers and loading bays. Street trees tend to be inconsistent, smaller scale and have limited influence on the character of the area with the exception of Moray Street which has reasonably consistent street trees. Power lines are also fairly dominant.

<i>Element</i>	<i>Description</i>
Dominant style	1970s - 1990s
Dominant scale	one and two storey
Dominant material	brick or masonry
Dominant roof	concealed by parapets/metal
Setback	less than 5 metres/consistent
Heritage	virtually no identified heritage places
Gardens	non-existent
Fences	buildings to property line

The existing urban character of the City of Port Phillip has been assessed using 24 character elements. The design should especially respond to the important and very important elements, which in this area are:

<i>Element</i>	<i>Importance</i>
Building scale	Very important
Land use	Very important
Lot size	Important
Traffic	Important
Parking	Important
Setbacks	Important
Building style	Important

A comprehensive urban character assessment and policy statement for the area is available from the Council .



City of Port Phillip
URBAN CHARACTER DESCRIPTION

AREA 74: KINGSWAY BETWEEN MARKET STREET AND QUEENS ROAD, SOUTH MELBOURNE

The following description should be used in carrying out the site analysis and design response to your site. Pay attention to the very important and important character elements listed here, as well as the actual conditions observed at the site analysis stage.

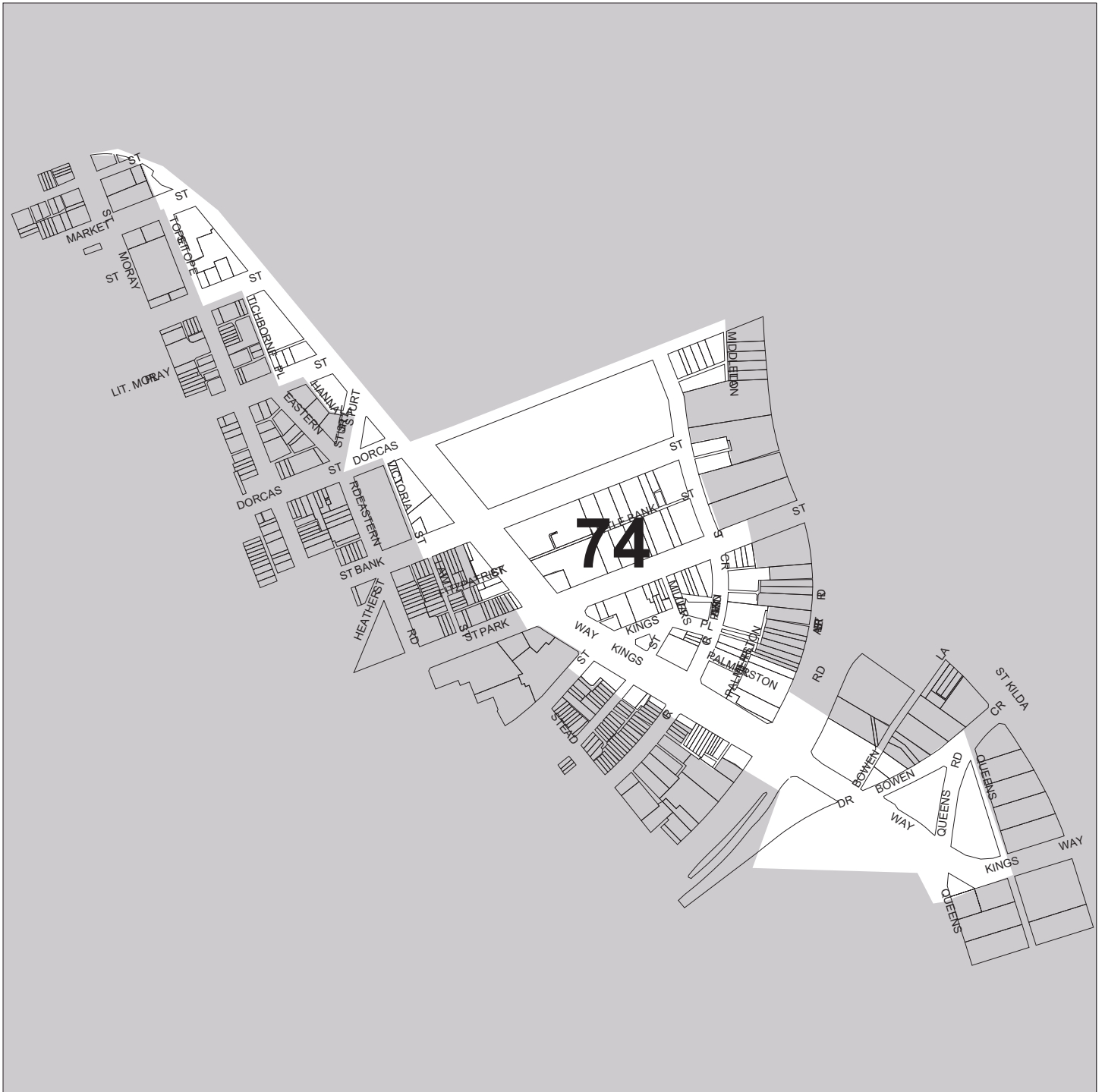

Boundary streets:

West Gate Freeway, Wells Cr, Kings Way, Dorcas St.

Streets in the area:

Bank St, Bowen Cr, Cobden St, Dorcas St, Hanna La, Kings Pl, Kings Way, Little Bank St, Matthews La, Middleton La, Millers La, Napier St, Palmerston Cr, Palmerston Pl, Park St, Queens La, Wells St, York St,

Description of the character of the area:

The dominant influence in this area is Kingsway which is an extremely busy approach road to the city.

Kingsway was originally a suburban street serviced by a tram route in much the same way as Park or Sturt Street, however with the opening of Kings Bridge during the post-war period, it was widened and upgraded to incorporate six through traffic lanes. This widening also involved the loss of most of the original buildings along the street and these have been gradually replaced with a mixture of offices, show rooms and road service related uses.

The area also includes Dorcas, Bank and Park Streets between Kings Way and Wells Street which supports office and show room uses and the recently closed Tram Depot.

The incremental upgrading of Kingsway within a restricted road reservation has resulted in poor and inconsistent street detailing, an abundance of overhead services and a lack of significant street trees.

Kings Way is a real barrier to pedestrian circulation in the area and traffic noise and fumes are significant.

<i>Element</i>	<i>Description</i>
Dominant style	1970s - 1990s
Dominant scale	one or more than three stories
Dominant material	brick or masonry/mixed
Dominant roof	concealed by parapets/metal
Setback	less than 5 metres/various
Heritage	no identified heritage places
Gardens	no boundary definition/small
Fences	buildings to property line/various

The existing urban character of the City of Port Phillip has been assessed using 24 character elements. The design should especially respond to the important and very important elements, which in this area are:

<i>Element</i>	<i>Importance</i>
Street dimensions	Very important
Traffic	Very important
Signage	Very important
Views	Important
Overhead services	Important
Building style	Important
Building scale	Important
Land use	Important

A comprehensive urban character assessment and policy statement for the area is available from the Council .



City of Port Phillip
URBAN CHARACTER DESCRIPTION

AREA 75: LAND GENERALLY BOUNDED BY GLADSTONE STREET, CROCKFORD STREET, YORK STREET AND BOUNDARY STREET, SOUTH MELBOURNE

The following description should be used in carrying out the site analysis and design response to your site. Pay attention to the very important and important character elements listed here, as well as the actual conditions observed at the site analysis stage.

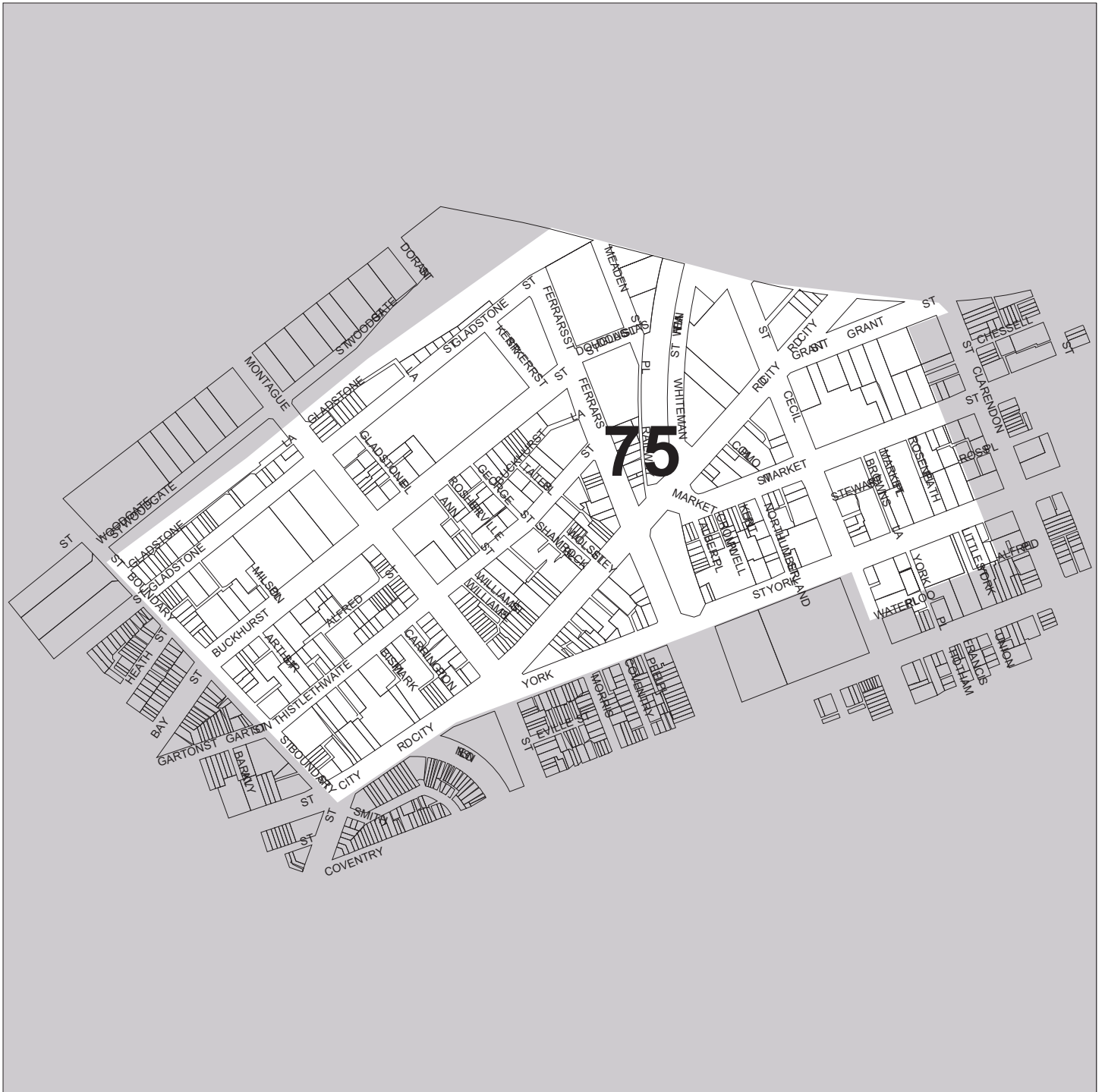

Boundary streets:

Gladstone St, Boundary St, Crockford St, City Rd, Clarendon St, West Gate Freeway.

Streets in the area:

Albert Pl, Alfred St, Ann St, Arthur St, Browns La, Buckhurst La, Buckhurst St, Cecil St, City Rd, Cromwell Pl, Douglas St, Ferrars St, George St, Gladstone La, Gladstone Pl, Gladstone St, Grant St, Karrington Pl, Kent Pl, Kerr St, Little York St, Market Pl, Market St, Milsom Pl, Montague St, Meaden St, Northumberland St, Peel Pl, Railway Pl, Roseneath Pl, Rosherville Pl, Shamrock Pl, Stewart Pl, Tates Pl, Thistlethwaite St, Whiteman St, Williams Pl, Williams St, Wolseley St, York Pl, York St, Alfred St, Waterloo Pl,

Description of the character of the area:

Providing services to the city, the area is distinguished from adjoining areas primarily by its industrial and commercial land uses including many printing, car repair, warehousing, building supplies and some office uses.

The street pattern is distorted by the converging grids of South Melbourne and Port Melbourne with City Road and Crockford Street passing through the area creating many angular junctions. Streets and lanes in the area have widely varying dimensions.

It has been partially developed with terrace housing, however most of these smaller sites with narrow frontages appear to have been amalgamated and developed for factory and offices uses.

With few residences remaining in the area, buildings have been constructed during the post-war period buildings vary from one to three storeys giving the area a reasonably consistent building scale.

City Road and Crockford Street seems to be attracting a higher proportion of showrooms, shops and corporate offices because of a more prominent address. Streets in the area retain elements of original street detailing and the area has fairly consistent bitumen footpaths throughout although they are often broken by concrete crossovers and loading bays. Street trees tend to be inconsistent and have limited influence on the character of the area. Power lines are also fairly dominant visually.

<i>Element</i>	<i>Description</i>
Dominant style	1970s - 1990s
Dominant scale	one and two storey
Dominant material	brick or masonry/mixed
Dominant roof	concealed by parapets/metal
Setback	less than 5 metres/consistent
Heritage	limited number of heritage places
Gardens	non-existent
Fences	buildings to property line

The existing urban character of the City of Port Phillip has been assessed using 24 character elements. The design should especially respond to the important and very important elements, which in this area are:

<i>Element</i>	<i>Importance</i>
Building scale	Very important
Land use	Very important
Traffic	Important
Parking	Important
Signage	Important
Setbacks	Important
Building style	Important

A comprehensive urban character assessment and policy statement for the area is available from the Council .



City of Port Phillip
URBAN CHARACTER DESCRIPTION

AREA 76: BAY STREET BETWEEN GRAHAM STREET AND INGLES STREET, PORT MELBOURNE

The following description should be used in carrying out the site analysis and design response to your site. Pay attention to the very important and important character elements listed here, as well as the actual conditions observed at the site analysis stage.

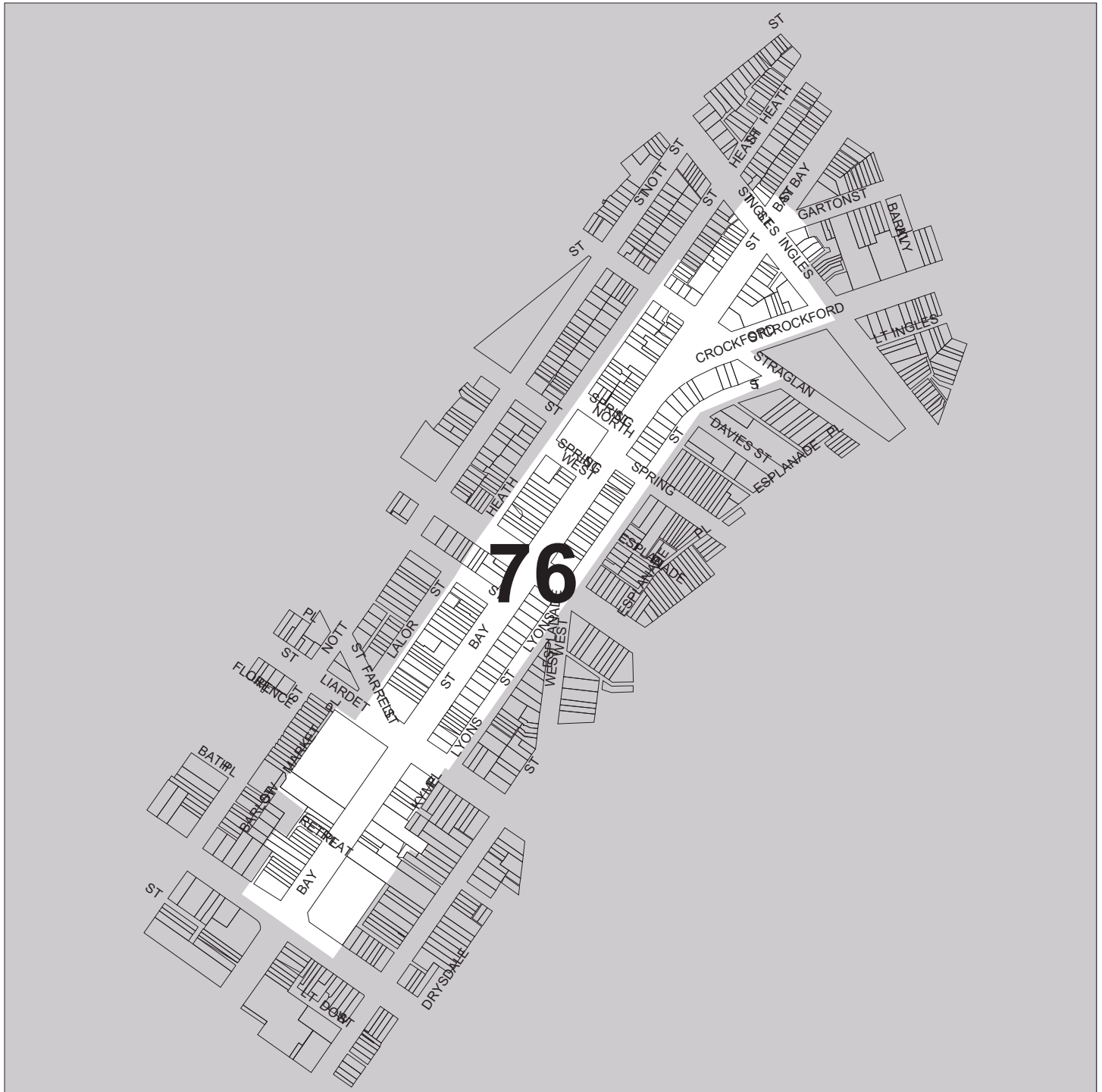

Boundary streets:

Bay St between Graham St and Ingles St.

Streets in the area:

Barlow St, Bay St, Crockford St, Ingles St, Lalor St, Liardet St, Market Pl,

Description of the character of the area:

Bay Street is a traditional strip shopping centre but also includes some residential, industrial and office uses. The boundary at the beach end of Bay Street has been drawn based on a reduced proportion of shops, higher traffic flows and a clear zoning intention to encourage new development.

The area was initially developed during the Victorian and Edwardian periods and most of the buildings from this period remain although there has been some redevelopment and renovation particularly on the southern side of the street. One and two storey buildings are generally built to the property line and many shops have verandahs.

Bay Street is a wide street with simple crossing intersections through most of its length except for the northern portion which forks to form Crockford Street. The street has a continuous grassed median planted with Brush Box trees through most of its length.

The area is significant for its consistent streetscape, building materials, colours and signage. Port Melbourne Town Hall is a focal building in the street.

<i>Element</i>	<i>Description</i>
Dominant style	pre-1900s
Dominant scale	one and two storey
Dominant material	stucco and render/consistent
Dominant roof	concealed behind parapets/metal
Setback	less than 5 metres/minor variation
Heritage	@90% identified heritage places
Gardens	visible/small
Fences	none

The existing urban character of the City of Port Phillip has been assessed using 24 character elements. The design should especially respond to the important and very important elements, which in this area are:

<i>Element</i>	<i>Importance</i>
Building scale	Very important
Views	Important
Pattern	Important
Street dimensions	Important
Parking	Important
Setbacks	Important
Building style	Important
Heritage	Important
Land use	Important
Access	Important

A comprehensive urban character assessment and policy statement for the area is available from the Council .



City of Port Phillip
URBAN CHARACTER DESCRIPTION

AREA 77: LAND GENERALLY BOUNDED BY BEACH STREET, ROUSE STREET, GRAHAM STREET AND PRINCES STREET, PORT MELBOURNE

The following description should be used in carrying out the site analysis and design response to your site. Pay attention to the very important and important character elements listed here, as well as the actual conditions observed at the site analysis stage.

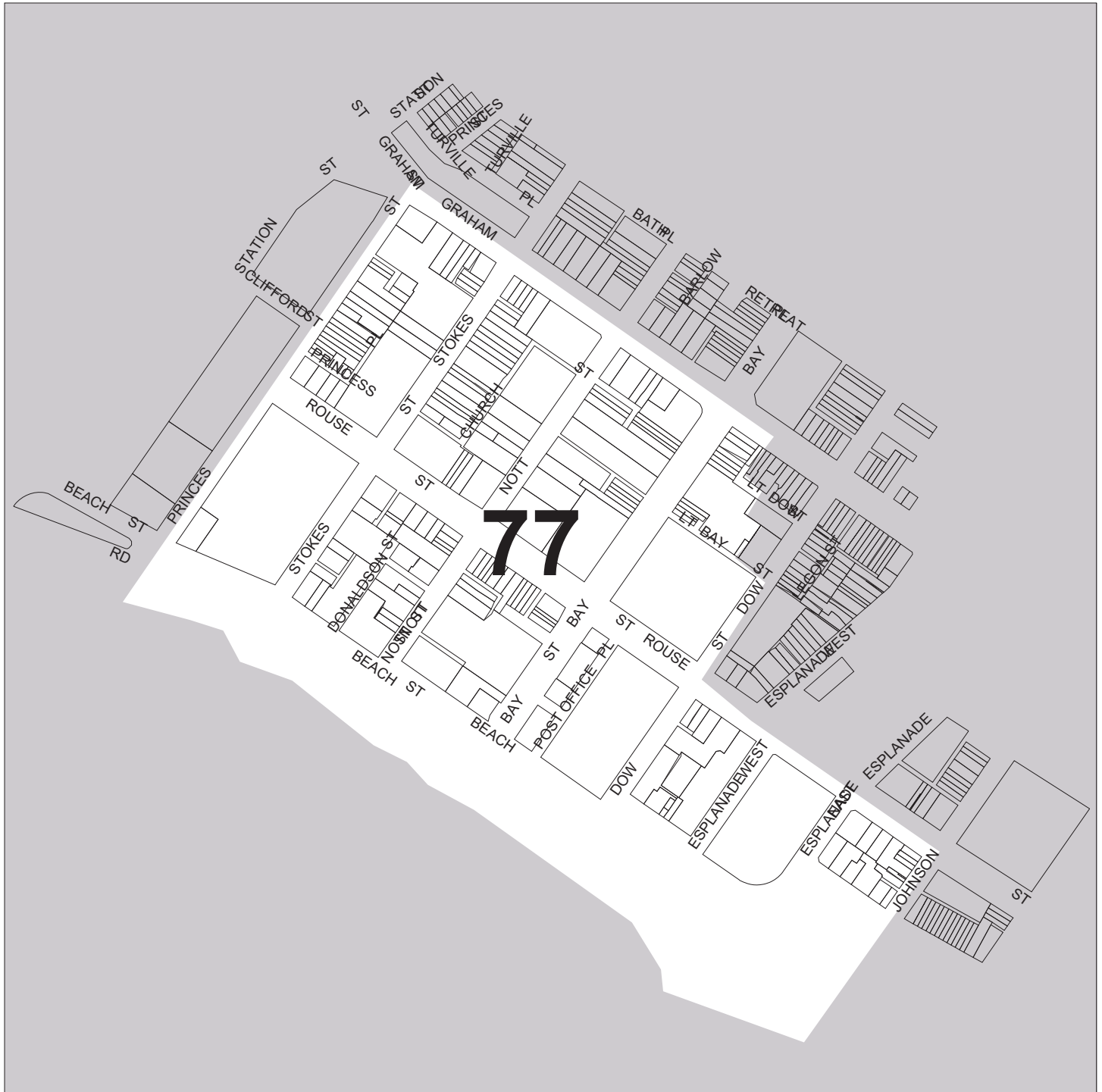

Johnson St, Beach St, Princes St, Graham St, Dow St, Rouse St.

Streets in the area:

Bay St, Beach St, Church St, Donaldson St, Dow St, Esplanade East, Esplanade West, Graham St, Little Bay St, Little Dow St, Nott St, Post Office Pl, Princes Pl, Princes St, Rouse St, Stokes St, Farrier Edwards La,

Description of the character of the area:

The area is essentially an industrial area in transition to a reasonably high density mixed use area. It includes traditional housing, new development, vacant land and the Bay Street shopping area.

Small pockets of the area, especially Stokes Street and Princes Street, have original terrace form housing on reasonably small lots, however most of the area is subdivided and developed into a wide range of lot sizes with many frontages well over twenty metres, and medium to large industrial buildings, some of which have been redeveloped for medium density housing. The area also has some office, entertainment and commercial uses.

Adjacent to Port Melbourne beach, it is effectively the last section of continuous beach and promenade extending beyond St Kilda.

Beach, Bay and Graham Streets are designated arterial roads and carry quite high volumes of private and commercial traffic. On-street parking generated by commercial, industrial and tourist uses also has a strong influence on the character of the area.

Streets are very mixed in their detailing and there are very few street trees in the area.

<i>Element</i>	<i>Description</i>
Dominant style	1970s -1990s
Dominant scale	three or more stories
Dominant material	stucco and render/mixed
Dominant roof	concealed by parapet/metal
Setback	less than 5 metres/minor variation
Heritage	limited number of identified heritage places
Gardens	visible
Fences	medium height/various materials

The existing urban character of the City of Port Phillip has been assessed using 24 character elements. The design should especially respond to the important and very important elements, which in this area are:

<i>Element</i>	<i>Importance</i>
Building scale	Very important
Foreshore	Very important
Views	Important
Lot size	Important
Traffic	Important
Parking	Important
Building style	Important
Housing type	Important
Land use	Important
Access	Important

A comprehensive urban character assessment and policy statement for the area is available from the Council .



City of Port Phillip
URBAN CHARACTER DESCRIPTION

AREA 78: LAND GENERALLY BOUNDED BY THE FORESHORE, PRINCES STREET, GRAHAM STREET, HOWE PARADE AND BARAK ROAD, PORT MELBOURNE

The following description should be used in carrying out the site analysis and design response to your site. Pay attention to the very important and important character elements listed here, as well as the actual conditions observed at the site analysis stage.

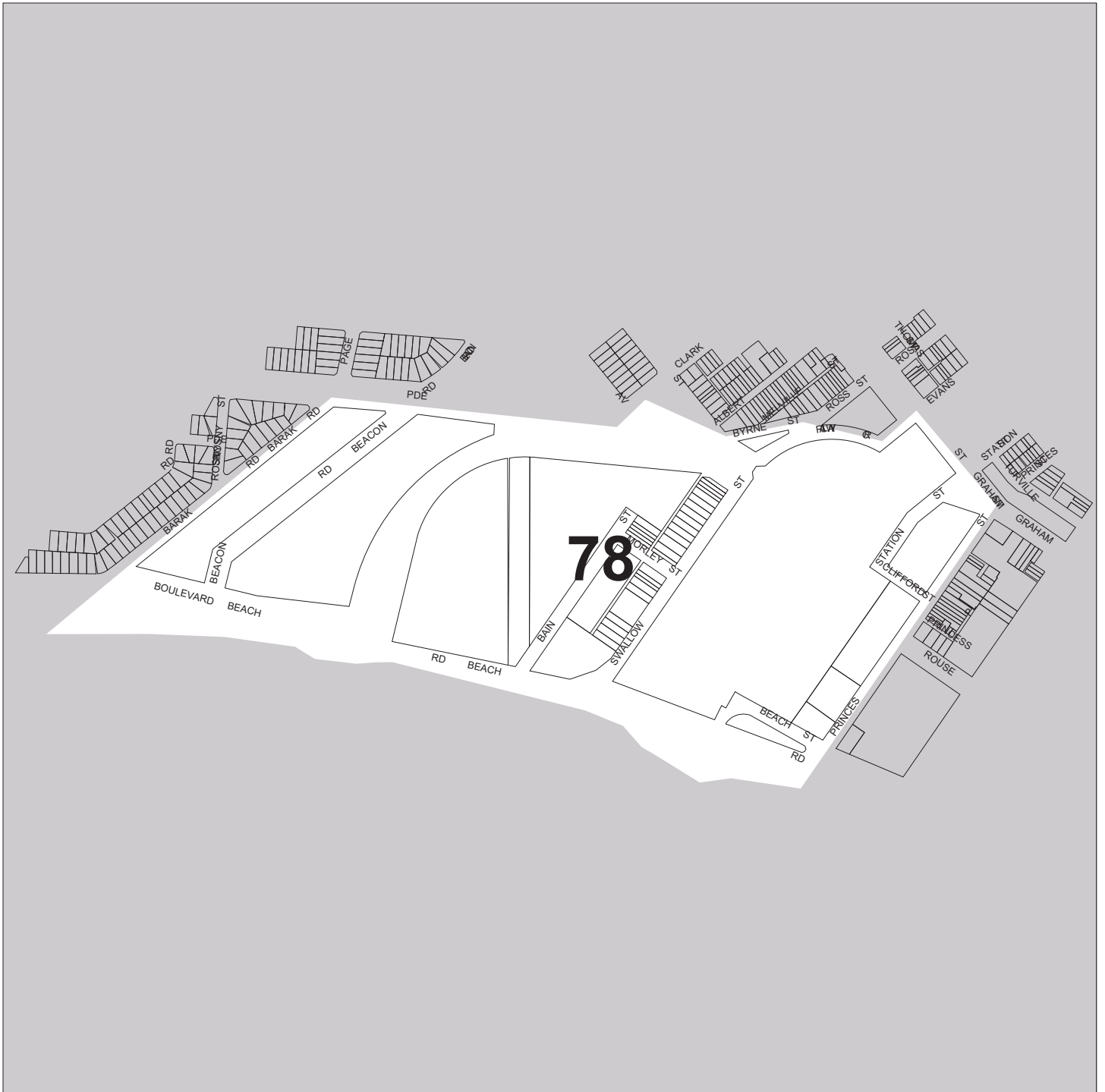

Foreshore, Princes St, Barak Rd, Howe Pde, Graham St.

Streets in the area:

Beach St, Beacon Rd, Canberra Pde, Centenary Dr, Clifford St South, Graham St, Harper Ct, Morley St, Railway Cr, Swallow St, Waterfront Pl, Webb Rd,

Description of the character of the area:

The area is characterised by a relatively undeveloped strip of foreshore, the light rail line passing through the area and terminating at Station Pier, and the strong blend of old and new architectural forms. These include a block of post-war public housing between Barak and Beacon Roads, a strip of Victorian houses along Swallow Street and a public housing estate off Princes Street. The balance of the area is currently being developed as a series of private housing estates.

The most recent private developments are typically two storey attached courtyard houses with lavish public landscape areas and no front boundary definition. They also include communal recreation and open space facilities developed and maintained to a high standard and subdivision layouts designed to deter through traffic.

There are limited shops and community services in the area with the result that trips to these facilities are generally by car.

<i>Element</i>	<i>Description</i>
Dominant style	1970s - 1990s
Dominant scale	two storey
Dominant material	stucco and render/consistent
Dominant roof	pitched/metal
Setback	less than 5 metres/minor variation
Heritage	
Gardens	visible/small
Fences	various height and materials

The existing urban character of the City of Port Phillip has been assessed using 24 character elements. The design should especially respond to the important and very important elements, which in this area are:

<i>Element</i>	<i>Importance</i>
Building style	Very important
Foreshore	Very important
Pattern	Important
Nature strips	Important
Street detailing	Important
Front gardens	Important
Building scale	Important
Housing type	Important

A comprehensive urban character assessment and policy statement for the area is available from the Council .



City of Port Phillip
URBAN CHARACTER DESCRIPTION

AREA 79: LAND GENERALLY BOUNDED BY WILLIAMSTOWN ROAD, BOUNDARY STREET, CROCKFORD STREET, BAY STREET AND GRAHAM STREET, SOUTH MELBOURNE

The following description should be used in carrying out the site analysis and design response to your site. Pay attention to the very important and important character elements listed here, as well as the actual conditions observed at the site analysis stage.

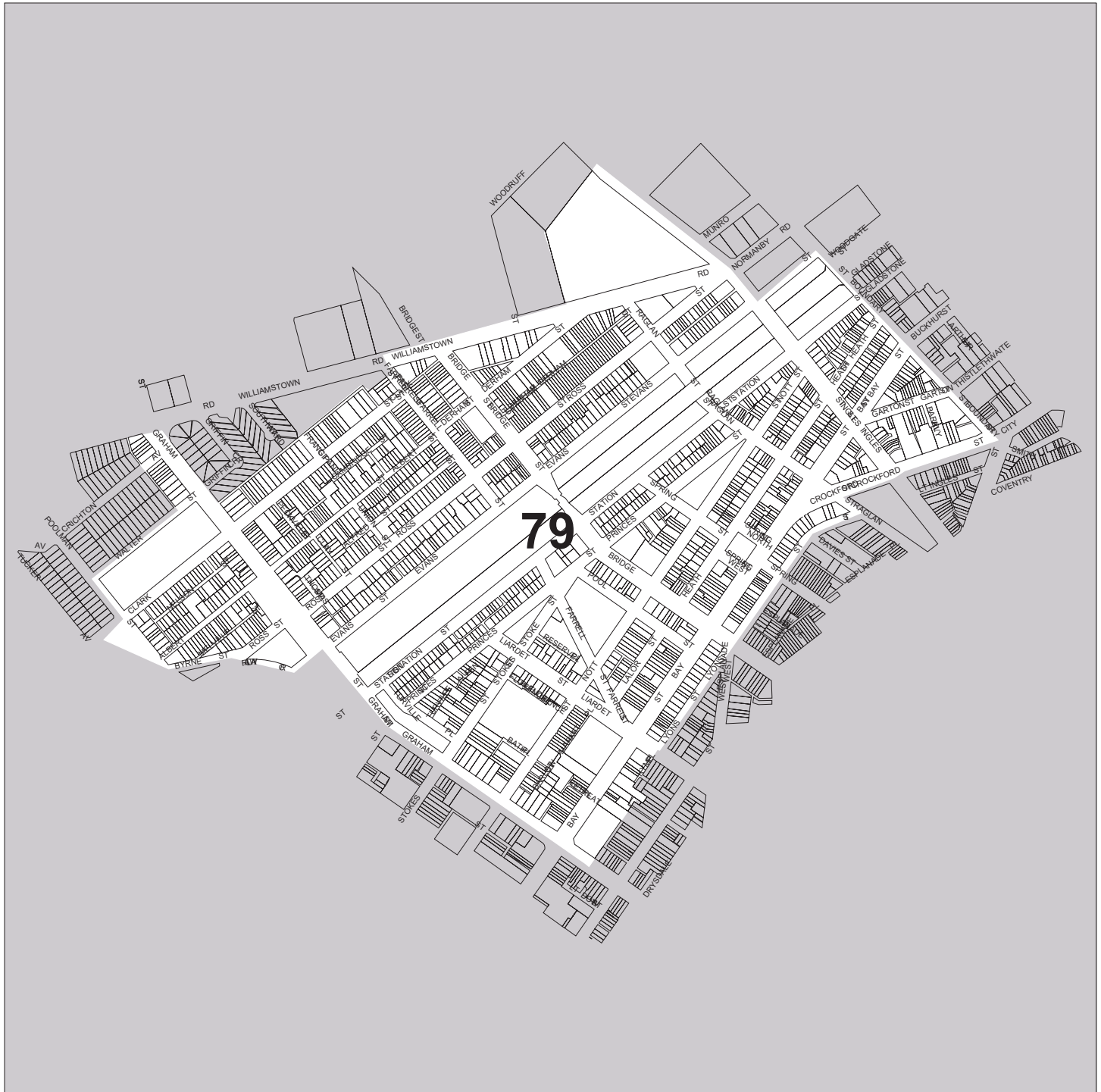

Boundary streets:

Williamstown Rd, Boundary St, Heath St, Graham St, Byrne St, Walter St, Clark St.

Streets in the area:

Albert St, Alfred St, Allen Pl, Barkly Av, Bath Pl, Bay St, Boundary St, Bridge St, Byrne St, Cambridge St, Clark St, Clay St, Crockford St, Derham St, Evans St, Farrell St, Florence Pl, Garton St, Graham St, Heath St, Ingles St, Liardet St, Little Derham St, Melville St, Nelson St, Nott St, Peckville St, Pool St, Poolman St, Princes St, Raglan St, Ross St, Spring St West, Spring St North, Spring St South, Station St, Stokes St, Thomas St, Turville Pl, Union St, Williamstown Rd, Stokes St, Farrell St, Princes St, Rowan's Ln, May Pl,

Description of the character of the area:

The area is characterised by the light rail line and a wide strip of open space bisecting a consistent style and scale of residential development.

Except for the public housing blocks in Stokes Street and a few non-residential buildings in Graham Street and Williamstown Road, the area has been predominantly developed with small scale Victorian cottages constructed in timber on small, narrow lots with reduced setbacks.

Streets are quite varied in their dimensions with some wide streets, a secondary system of small streets and a network of rear lane ways. Original detailing in these streets has been largely replaced with simple concrete kerb and channel and only a few laneways retain original bluestone pavements and detailing.

Some streets have mature trees, however, the area has been subject to many planting fashions resulting in inconsistent and mixed planting.

<i>Element</i>	<i>Description</i>
Dominant style	pre-1900s
Dominant scale	one storey
Dominant material	timber of cladding/minor variation
Dominant roof	pitched/metal
Setback	less than 5 metres/consistent
Heritage	@50% identified heritage places
Gardens	visible/small
Fences	medium height/various materials

The existing urban character of the City of Port Phillip has been assessed using 24 character elements. The design should especially respond to the important and very important elements, which in this area are:

<i>Element</i>	<i>Importance</i>
Building scale	Very important
Lot size	Important
Overhead services	Important
Fences	Important
Setbacks	Important
Building style	Important
Housing type	Important
Heritage	Important
Access	Important
Open space	Important

A comprehensive urban character assessment and policy statement for the area is available from the Council .



City of Port Phillip
URBAN CHARACTER DESCRIPTION

AREA 80: LAND BOUNDED BY THE BOULEVARD, TODD ROAD, WILLIAMSTOWN ROAD, HOWE PARADE AND BARAK PARADE, PORT MELBOURNE

The following description should be used in carrying out the site analysis and design response to your site. Pay attention to the very important and important character elements listed here, as well as the actual conditions observed at the site analysis stage.

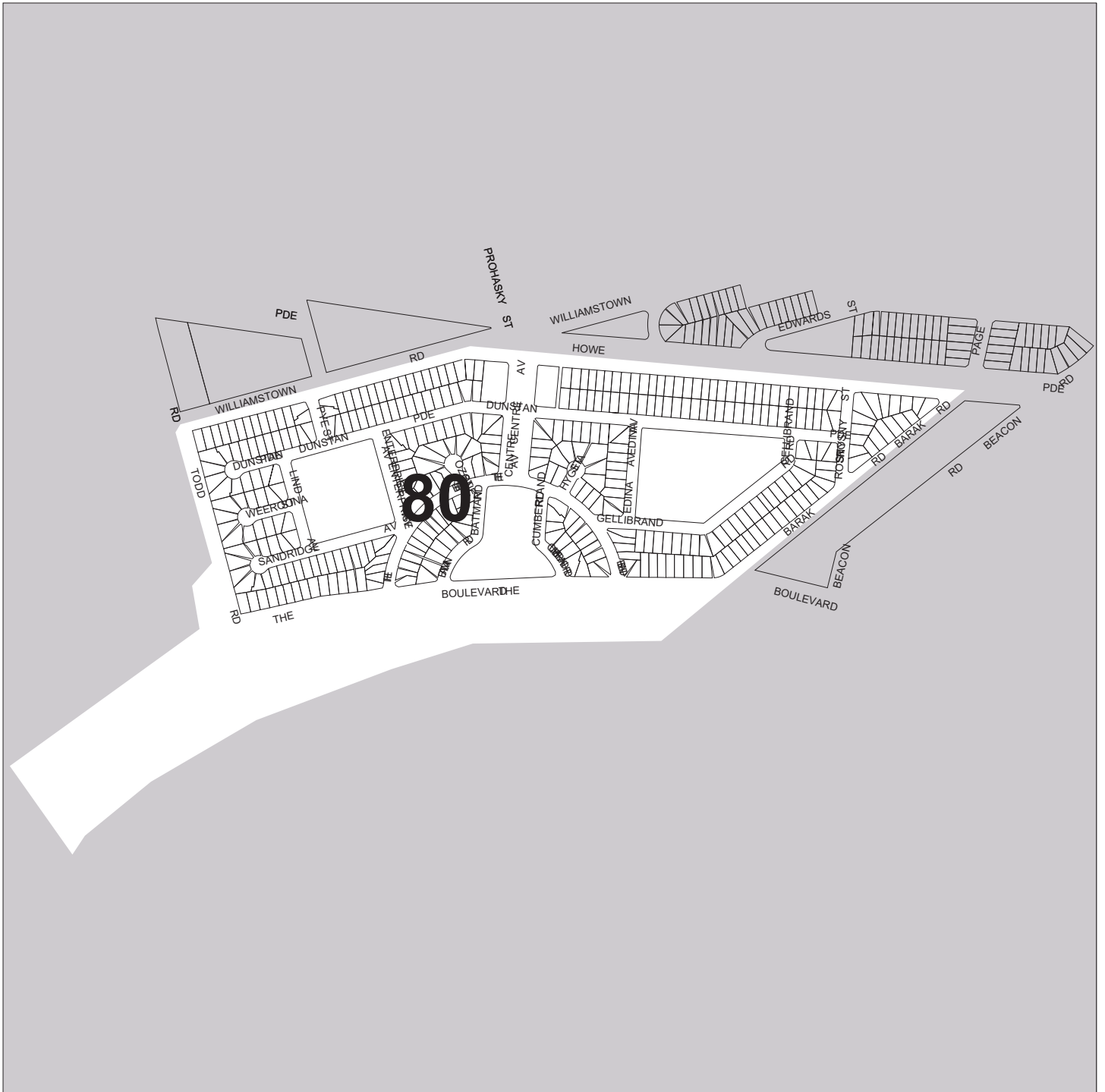

Boundary streets:

The Boulevard, Todd Rd, Williamstown Rd, Howe Pde, Barak Pde.

Streets in the area:

Barak Rd, Batman Rd, Centre Av, Cumberland Rd, Dunstan Pde, Edina Av, Enterprise Av, Gellibrand Rd, Hygeia St, Lind Av, Ozone St, Rosny St, Sandridge Av, The Bend, The Boulevard, Weeroona St, The Boulevard,

Description of the character of the area:

This area is a planned public housing estate from the inter-war period, similar in many respects to the Garden City estate except for clear differences in housing scale, design, open space and relationship to the foreshore.

It has been designed with axial and curvilinear roads permeating uniform lot sizes of approximately 300 square metres.

All houses are duplex and built in accordance with a set of standard designs. They are usually setback about 5 metres and either face wide boulevards or one of three open spaces. Houses on corner sites have a corner orientation and the limited number of two storey houses are usually located on corner sites.

Properties generally have open front gardens enclosed by a wide range of fence types that have replaced the original low wire mesh fences. Similarly, some houses have undergone inappropriate renovations and car ports have been constructed within the front setback areas.

Streets retain their consistent detailing throughout the area, however street trees fail to enhance the area due to replacement planting of deciduous trees with mixed natives.

<i>Element</i>	<i>Description</i>
Dominant style	1920s -1940s
Dominant scale	one and two storey
Dominant material	brick or masonry/minor variation
Dominant roof	pitched/terracotta
Setback	5-9 metres/consistent
Heritage	no identified heritage places
Gardens	visible/medium
Fences	low-medium height/various materials

The existing urban character of the City of Port Phillip has been assessed using 24 character elements. The design should especially respond to the important and very important elements, which in this area are:

<i>Element</i>	<i>Importance</i>
Lot size	Very important
Pattern	Very important
Housing type	Very important
Open space	Very important
Foreshore	Very important
Views	Important
Nature strips	Important
Street detailing	Important
Fences	Important
Setbacks	Important
Building style	Important
Building scale	Important
Heritage	Important
Land use	Important

A comprehensive urban character assessment and policy statement for the area is available from the Council .



City of Port Phillip
URBAN CHARACTER DESCRIPTION

AREA 81: LAND GENERALLY BOUNDED BY WILLIAMSTOWN ROAD, HOWE PARADE, WALTER STREET AND CLARK STREET, PORT MELBOURNE

The following description should be used in carrying out the site analysis and design response to your site. Pay attention to the very important and important character elements listed here, as well as the actual conditions observed at the site analysis stage.

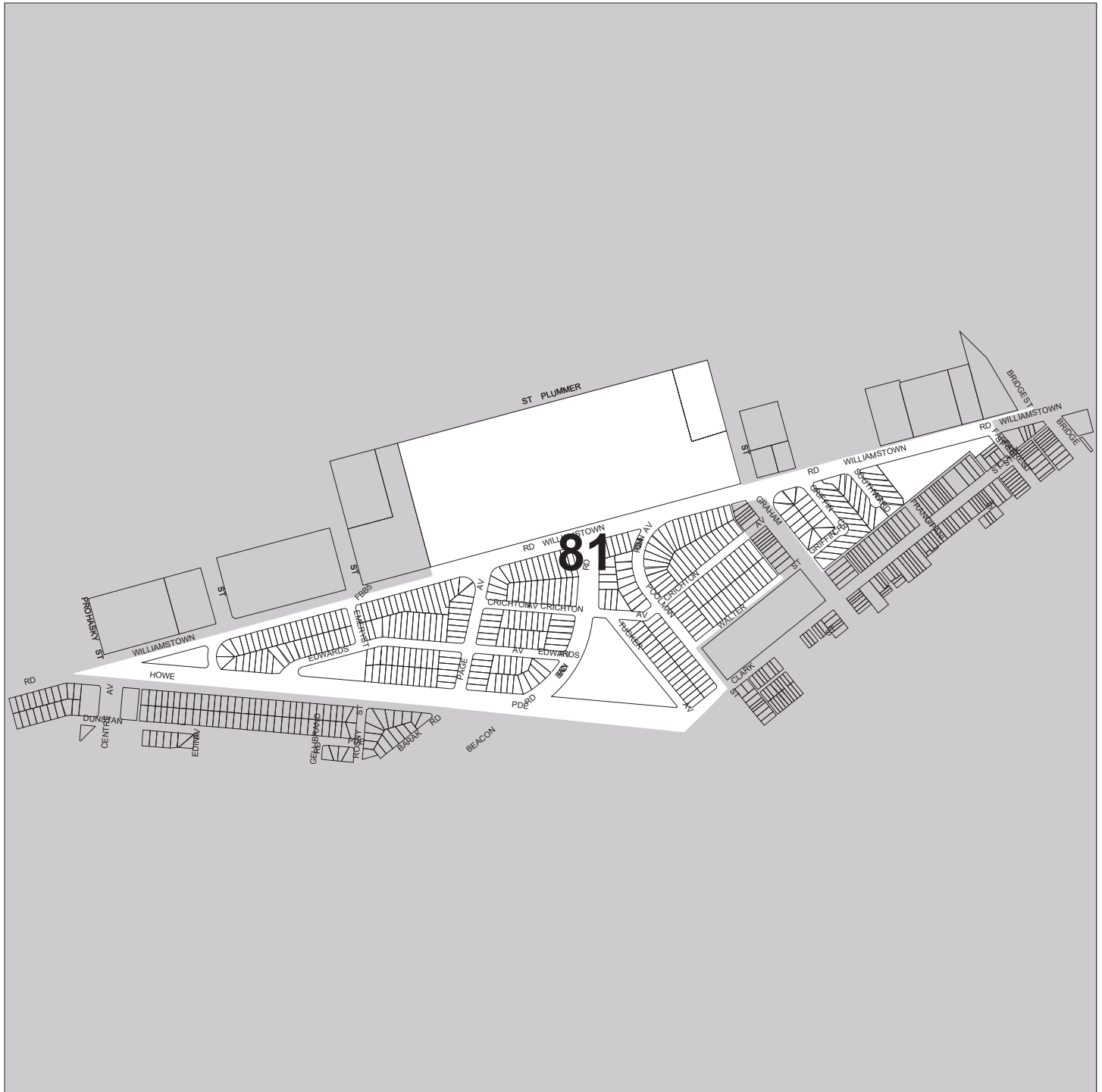

Boundary streets:

Williamstown Rd, Howe Pde, Walter St, Clark St.

Streets in the area:

Beacon Rd, Centre Av, Crichton Av, Edwards Av, Frangipani Ct, Griffin Cr, Howe Pde, Page Av, Poolman St, Southward Av, Tucker Av, Walter St, Williamstown Rd,

Description of the character of the area:

This area includes the Garden City housing estate built between 1926-48 and the Griffith Crescent/Southward Avenue estate built by the State Government for rental in 1936. Both estates have similar road layouts, lot sizes and housing scale but building styles differ.

The Garden City estate is the larger estate distinguished by its street detailing of crisp precast concrete kerb and channel and concrete roads, crossings and footpaths, giving a distinctive appearance to the public realm. It also includes areas of open space together with a major sporting area at J.L. Murphy Reserve on the other side of Williamstown Road.

Factors which detract from the consistency of these areas are the occasional inappropriate colour scheme, modified windows or carports, the variation in fencing and the quality of street trees.

<i>Element</i>	<i>Description</i>
Dominant style	1920s - 1940s
Dominant scale	two storey
Dominant material	stucco and render
Dominant roof	pitched/terracotta
Setback	5-9 metres/consistent
Heritage	@75% identified as heritage place
Gardens	visible/medium
Fences	medium-high/various materials

The existing urban character of the City of Port Phillip has been assessed using 24 character elements. The design should especially respond to the important and very important elements, which in this area are:

<i>Element</i>	<i>Importance</i>
Lot size	Very important
Street detailing	Very important
Building style	Very important
Building scale	Very important
Heritage	Very important
Pattern	Important
Street dimensions	Important
Nature strips	Important
Parking	Important
Fences	Important
Setbacks	Important
Front gardens	Important
Housing type	Important
Land use	Important
Open space	Important

A comprehensive urban character assessment and policy statement for the area is available from the Council .



City of Port Phillip
URBAN CHARACTER DESCRIPTION

AREA 82: LAND GENERALLY BOUNDED BY TODD ROAD, WESTGATE FREEWAY, WILLIAMSTOWN ROAD AND WOODGATE STREET, PORT MELBOURNE

The following description should be used in carrying out the site analysis and design response to your site. Pay attention to the very important and important character elements listed here, as well as the actual conditions observed at the site analysis stage.

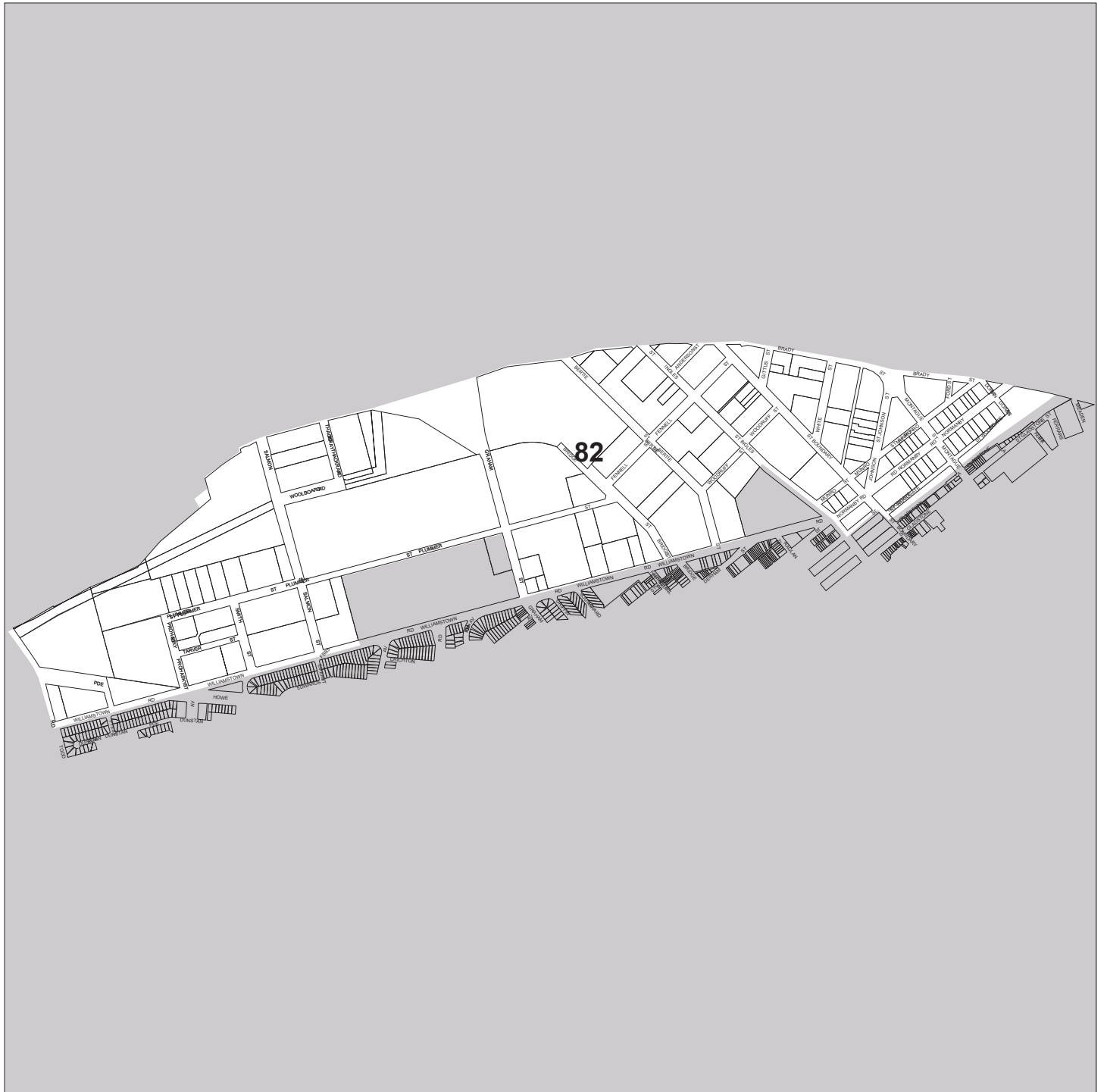

Boundary streets:

Todd Road, Wesgate Freeway, Williamstown Road, Woodgate Street.

Streets in the area:

Anderson St, Bertie St, Boundary St, Brady St, Bridge St, Doran St, Emery St, Evans St, Fennell St, Gittus St, Graham St, Ingles St, Johnson St, Leith Cr, Montague St, Munro St, Normanby Rd, Plummer St, Prohasky St, Pye St, Salmon St, Smith St, Tarver St, Thackray Rd, White St, Williamstown Rd, Woodgate St, Woodruff St, Wool Board Rd, Boundary St, Howe Pde,

Description of the character of the area:

As an extension of Fishermens Bend on the other side of the Westgate Freeway, this area has extremely large lots which have been developed with large factories or other commercial buildings during the inter-war period.

Streets are generally quite wide although some are just local streets free of through traffic. Nevertheless, the majority are collector and arterial roads carrying heavy traffic.

Although there are some quite good plantations in the area, the streets generally look less cared for than those of residential areas due to the lack of continuity of design and inadequate maintenance. Overhead services are visually intrusive and there are no footpaths in many places.

<i>Element</i>	<i>Description</i>
Dominant style	1920s - 1940s
Dominant scale	one and two storey
Dominant material	timber or cladding/mixed
Dominant roof	flat/metal
Setback	less than 5 metres/varied
Heritage	no identified heritage places
Gardens	visible/large
Fences	high/various materials

The existing urban character of the City of Port Phillip has been assessed using 24 character elements. The design should especially respond to the important and very important elements, which in this area are:

<i>Element</i>	<i>Importance</i>
Lot size	Very important
Setbacks	Very important
Building scale	Very important
Street dimensions	Important
Traffic	Important
Overhead services	Important
Land use	Important

A comprehensive urban character assessment and policy statement for the area is available from the Council .



Fishermans Bend Estate Guidelines

Revised Feb 2021



This page has been intentionally left blank

Source: Nearmap (Aerial photo taken April 2019).

Contents

Introduction

Purpose	5
Application	5
How to use the Guidelines	5

Guideline Basis

History	7
Significance of Fishermans Bend Estate	9
Contributory features	10

Guideline 1: Conservation

Guideline basis	14
General guidelines	14
Roofs guidelines	14
Walls and gable ends guidelines	14
Porches guidelines	15
Windows and doors guidelines	16
Painting guidelines	17

Guideline 2: Alterations & Additions

Guideline basis	19
General guidelines	19
Single storey additions guidelines	21
Two storey additions to two storey dwellings guidelines	22
Two storey additions to single storey dwellings guidelines	23

Guideline 3: Car Parking

Guideline basis	25
Guidelines	25



Guideline 4: Fencing

Guideline basis	27
New fence guidelines	28
General guidelines	28

Guideline 5: Front Garden

Guideline basis	31
Guidelines	31

Guideline 6: Public Realm & Infrastructure

Application	33
Guideline basis	33
Guidelines	33

Guideline 7: Subdivision

Guideline basis	35
Guidelines	35

Purpose

The Housing Commission of Victoria (HCV) Fishermans Bend Estate is a significant heritage place. It is essential that the City of Port Phillip and its residents maintain and enhance its unique character. It is also important that the needs of individual property owners are recognised. These guidelines aim to balance these objectives. They describe the features that make the Fishermans Bend Estate significant and offer suggestions to help owners maintain its significance, whilst allowing for renovations and development to occur.

The guidelines were initially prepared in 1997 and updated in 2010 and 2020. This version has been prepared to ensure alignment with updated heritage policy at Clause 15.03-1L of the Port Phillip Planning Scheme and the City of Port Phillip Heritage Design Guidelines (Background Document listed at clause 72.08 of the scheme).

Application

The guidelines apply to the HCV Fishermans Bend Estate, which is in two parts (refer to Figure 1). The main part containing 376 dwellings comprises all the land bounded by The Boulevard to the south, Todd Road to the west, Howe Parade and Williamstown Road to the north and Barak Avenue to the east. The other part is 444-478 Williamstown Road, which contains 36 flats in nine two-storey blocks, known as the 'Quartets'.

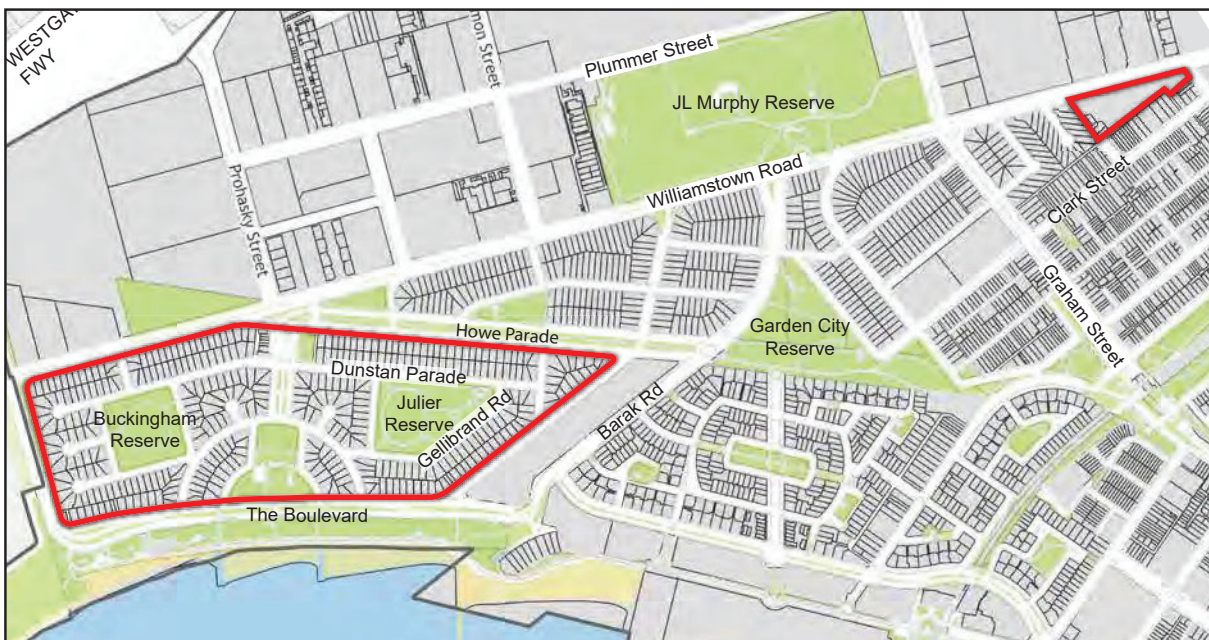

Figure 1: The boundaries of the Fishermans Bend Estate (at left) and the 'Quartets' (top right) shown in red

How to use the Guidelines

The guidelines explain what Council will take into consideration when assessing a planning permit application for development or subdivision of land in accordance with Clause 43.01 Heritage Overlay of the Port Phillip Planning Scheme.

The guidelines should be considered in conjunction with State and local heritage policy at Clause 15.03 of the Port Phillip Planning Scheme, and the City of Port Phillip Heritage Design Guidelines.

In the event of any inconsistency between the guidelines and the City of Port Phillip Heritage Design Guidelines, these guidelines should be used for applications within the Fishermans Bend Estate.

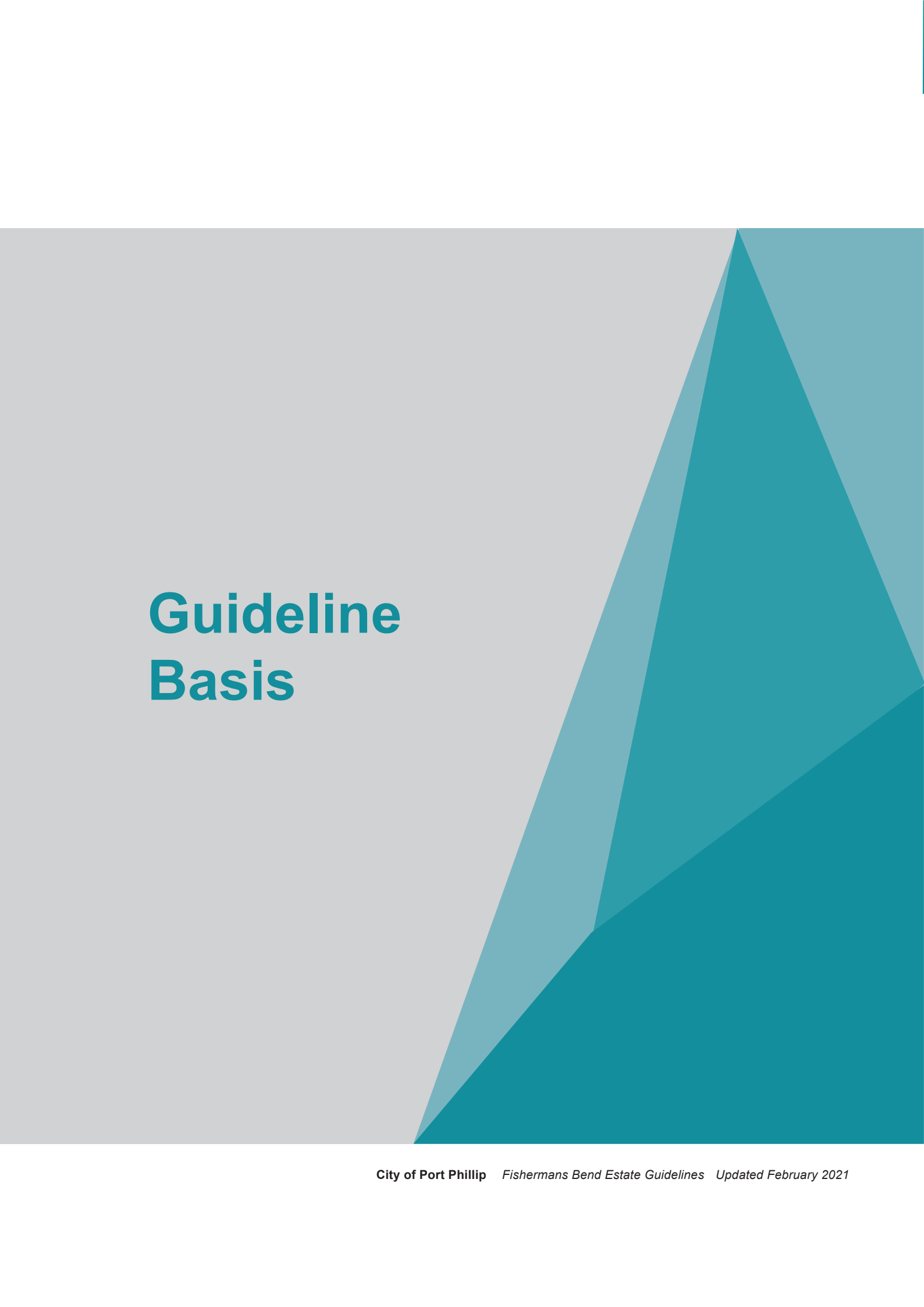
The background features a large, abstract geometric composition. On the right side, there are several overlapping triangular shapes in various shades of teal and blue, pointing towards the top right. The left side of the page is a solid, light grey color. The text 'Guideline Basis' is positioned on the left, overlapping the grey area.

Guideline Basis

History

The HCV Fishermans Bend Estate was built between 1939 and 1942, by the newly formed Housing Commission of Victoria (HCV) as the first in the series of estates constructed by the HCV which played a critical role in addressing housing shortages after World War II.

Fishermans Bend Estate followed the only two substantial initiatives in the field of assisted and public housing to that time, both also in Port Melbourne. The first was the State Bank Estate (known as Garden City Estate), started in 1926 and the second, the small Dunstan Estate at the corner of Williamstown Road and Graham Street, built by the Public Works Department for then Premier Albert Dunstan's Government in 1936. Thus the area south of Williamstown Road contains the physical expression of the genesis of assisted and public housing in the State of Victoria. Consequently, the area has historic and social significance to the municipality.

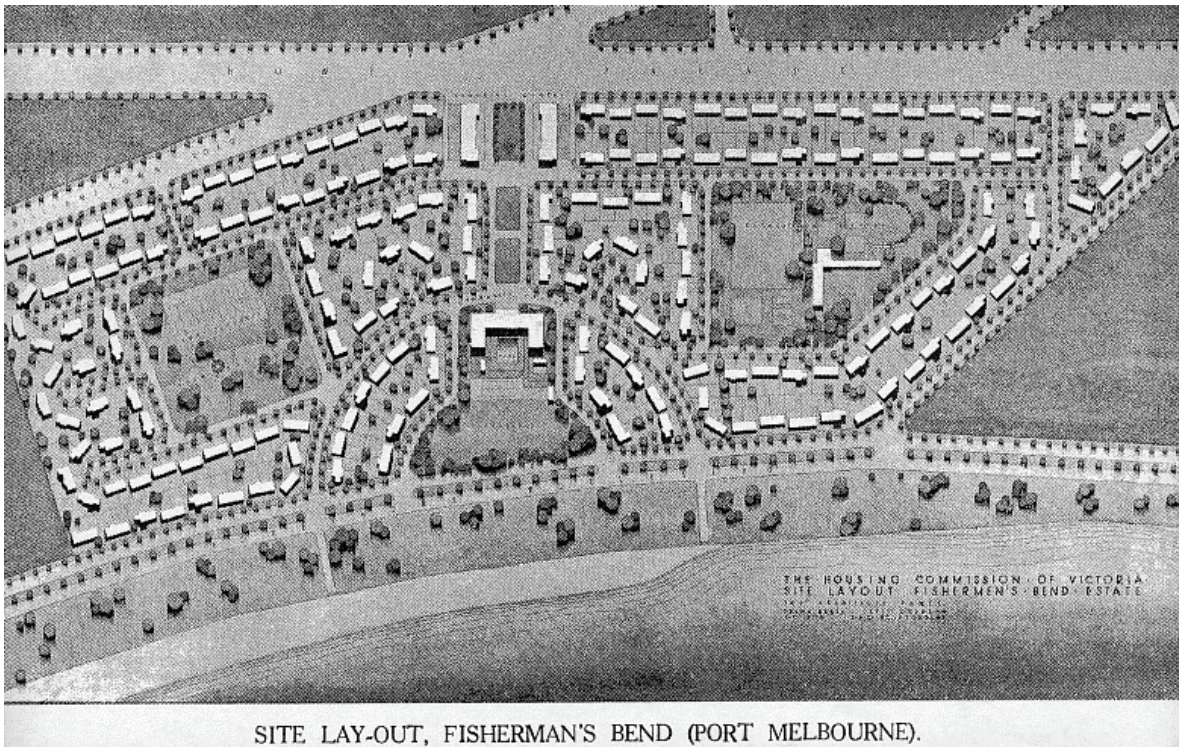

Figure 2. The original layout plan of Fishermans Bend Estate (Source: Second Report of the Housing Commission of Victoria, 1940.).

Note the central spine with the shopping centre at the north and the proposed community centre at the south, the organised layout of the reserves and the proposed regular street tree planting.

The HCV Fishermans Bend Estate represents the State's answer to the interwar and postwar housing crises and demonstrates the power of the social reformers, most particularly the indefatigable Oswald Barnett, to influence government policy.

Its physical expression, incorporating Garden City concepts from England and the latest American ideas in estate layout, is considered to be the finest example of a housing estate ever built by the HCV and provided a model for estates that followed. It was designed to incorporate all of the facilities a neighbourhood community could require - shops, community centre, recreation space and a kindergarten. Its original intent, with fully integrated shopping, sporting and recreational facilities and street tree planting was never fully realised; however, the overall structure and housing types remains in accordance with the original plan.

It is also important as the cradle of the HCV's concrete house project, employing the techniques of TW Fowler, which formed the basis of the massive housing program to follow after the war. The first experimental concrete dwellings (at 324-326 Howe Parade) still remain and are included on the Victorian Heritage Register (see Figure 4). These experimental concrete dwellings were the prototype for the concrete dwellings built in the estate and the HCV estates that followed (see Figure 5).



Figure 4 The first experimental dwellings using the TW Fowler system of concrete prefabrication, 324-326 Howe Parade, Fishermans Bend Estate.



Figure 5. One of the most intact early concrete dwellings, 350 Howe Parade, Fishermans Bend Estate.

Note the splayed roof verge and gutter, the small concrete entry canopy carried on slender steel posts, the timber sliding sashes with horizontal glazing bars and the pipe and wire mesh fence.

Significance of Fishermans Bend Estate

The HCV Fishermans Bend Estate is of local heritage significance and is included within the heritage overlay of the Port Phillip Planning Scheme as part of HO2 The Garden City Housing Estates heritage precinct. The HO2 precinct comprises the three garden city estates, including Fishermans Bend Estate (apart from the first experimental concrete dwellings at 324-326 Howe Parade which are on the Victorian Heritage Register and have an individual heritage overlay, HO158), the Garden City (Bank House) Estate and the Dunstan Estate.

The main basis of the Fishermans Bend Estates' significance are as follows

- It is the first experiment in public housing for rental by a State Government instrumentality in Australia, the Housing Commission of Victoria (HCV), and formed the baseline of their massive housing program to follow. It was the first step in the dominant pattern of social engineering employed by the HCV until the 1970's.
- It is the first and only estate by a government instrumentality derived from a design competition.
- It contains the first experimental concrete dwellings and the first group of concrete dwellings built in Victoria, using the TW Fowler system of prefabrication, that was to form the basis of much of the HCV's later program and which led to the mass production facilities at Holmesglen and ultimately to the HCV high rise construction program.
- It employs a combination of the most up to date ideas in planning and urban design from England and America, such as its geometry, curved streets, the use of residential courts and creation of neighbourhoods.
- Its proposed social and physical integration of community facilities is to a degree not seen again in estate planning in Australia.
- It is the finest example of a HCV estate in both architectural and urban design terms.
- In spite of some change, it is substantially intact and still clearly expresses its original intent.

Fishermans Bend Estates owes its special character to the vision of its social and physical planners, expressed in the clarity and ordered variety of its design, with strategically placed two storey elements in the single storey context, its unique layout and infrastructure, with open space defining its two precincts. The consistent use of attached dwellings built form and materials enhance its individuality.

It is a unique demonstration of the concepts of planners of the time, not so comprehensively expressed anywhere else in Australia.

Contributory features

The layout, original buildings (including the dwellings), the communal open spaces and the shopping centre contribute to the special character of the place as a whole; for it is the whole place that is important. The individual elements each help establish and reinforce the consistency of the overall character in their variations of repeating forms, materials and construction details.

The contributory features are:

1. The scale of the buildings. The area was designed as a lower “working class” estate and thus its origins are expressed in its housing stock of small dwellings on small sites, devised in accordance with the social philosophies and economic constraints of the time. This is the core of its cultural significance and is fundamental to any consideration of the fabric of the place.
2. The overall street layout and the specifics of its design, including the curvilinear streets, which produced ordered variety in the orientations of the dwellings.
3. The symmetrical placement of facilities in the central spine between the foreshore and Williamstown Road.
4. The open space areas, which balance the composition, define two distinct precincts, and which allow the long views that add to and reveal the special character of the area.
5. The designs of the individual dwellings as pairs and their consistent repetition of elements and massing, which add to the strong identity of the area.

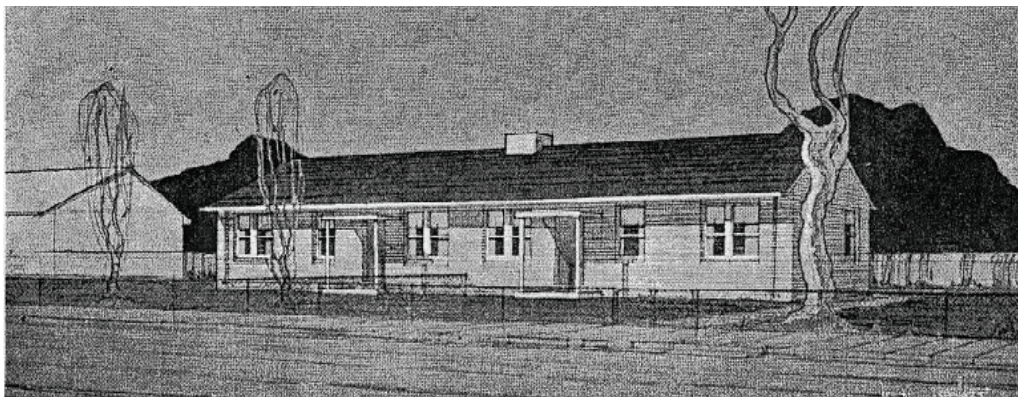

Figure 6. Design perspective of the pair of six-bed houses

6. The consistent use of similar materials, relieved by sections with concrete, rather than brick dwellings, and the subtle variations in the bricks used, ranging from over-burnt (clinker) to pink.
7. The siting of the two storey dwellings at strategic locations, generally on street corners, but also breaking up long sweeps of single storey buildings.
8. The varied setbacks of the pairs, which relieve the potential monotony of their similar designs and the diagonal siting of corner dwellings.
9. The consistent detailing of the individual pairs including their roofs, roof drainage, gable ends, walls, windows and doors, chimneys and porches.
10. The consistent design of front fences of low height, particularly the early galvanised pipe and chain wire mesh examples with high paling fences used only behind the fronts of the dwellings.
11. The alterations to the porches and windows which have been made by the HCV since the original construction of the estate.
12. The stepped frontage of shops to Central Avenue.
13. The form and function of the Community Centre on Central Avenue.



Figure 7. Typical strategic corner location of a two storey pair of dwellings.



Figure 8. A streetscape showing the contrasting two storey pair, the varied setbacks and the consistently low pipe and wire mesh fences.



Figure 9. The two storey pairs of dwellings at the corners of Dunstan Parade and Centre Avenue frame the vista of the street. The vista was originally intended to be closed by the community centre.

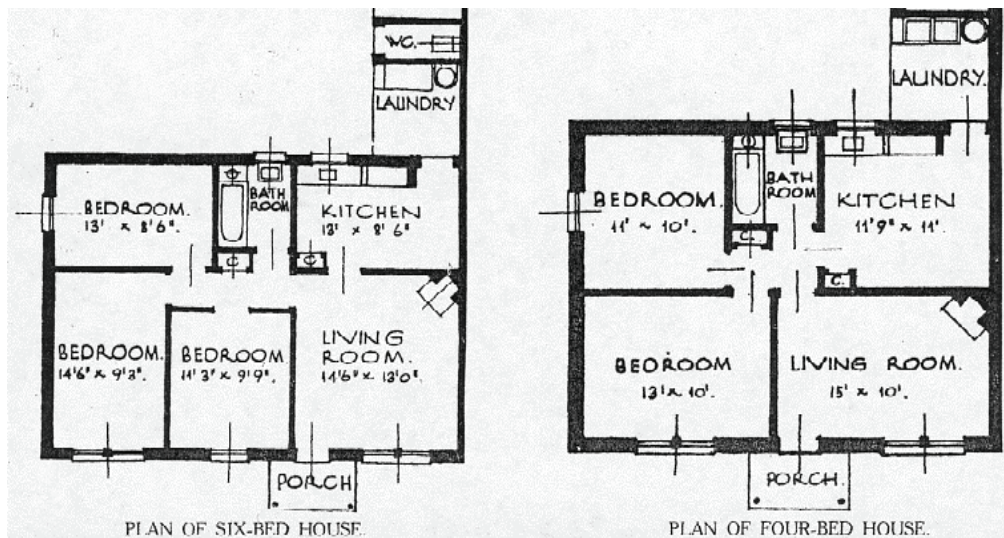

Figure 10. Typical plans of the medium size dwellings. Source: Second Report of the HCV, 1940.

The ‘Quartets’

The “Quartets” (see Figure 11), nine two storey blocks, each of four small flats, at 444-478 Williamstown Road, are designed with similar guidelines in mind. Although repetitive in form, their staggered layout responds to the triangular site and creates a forecourt area, giving a strong sense of identity. These features make Fishermans Bend Estate a unique environment far removed from the popular idea of a characterless HCV estate.

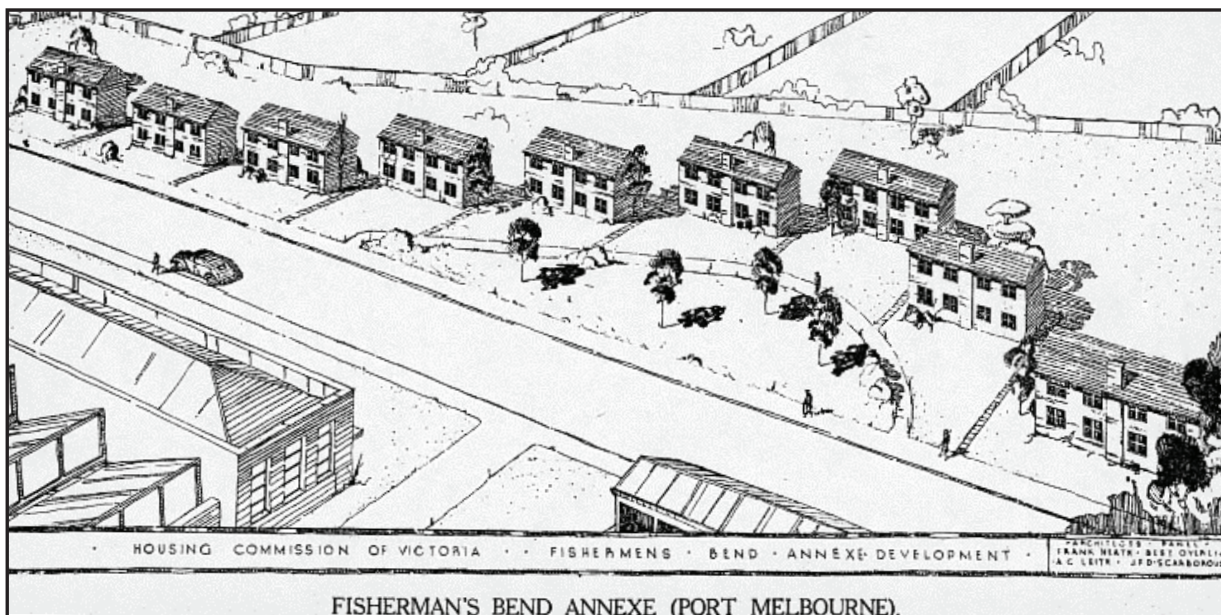
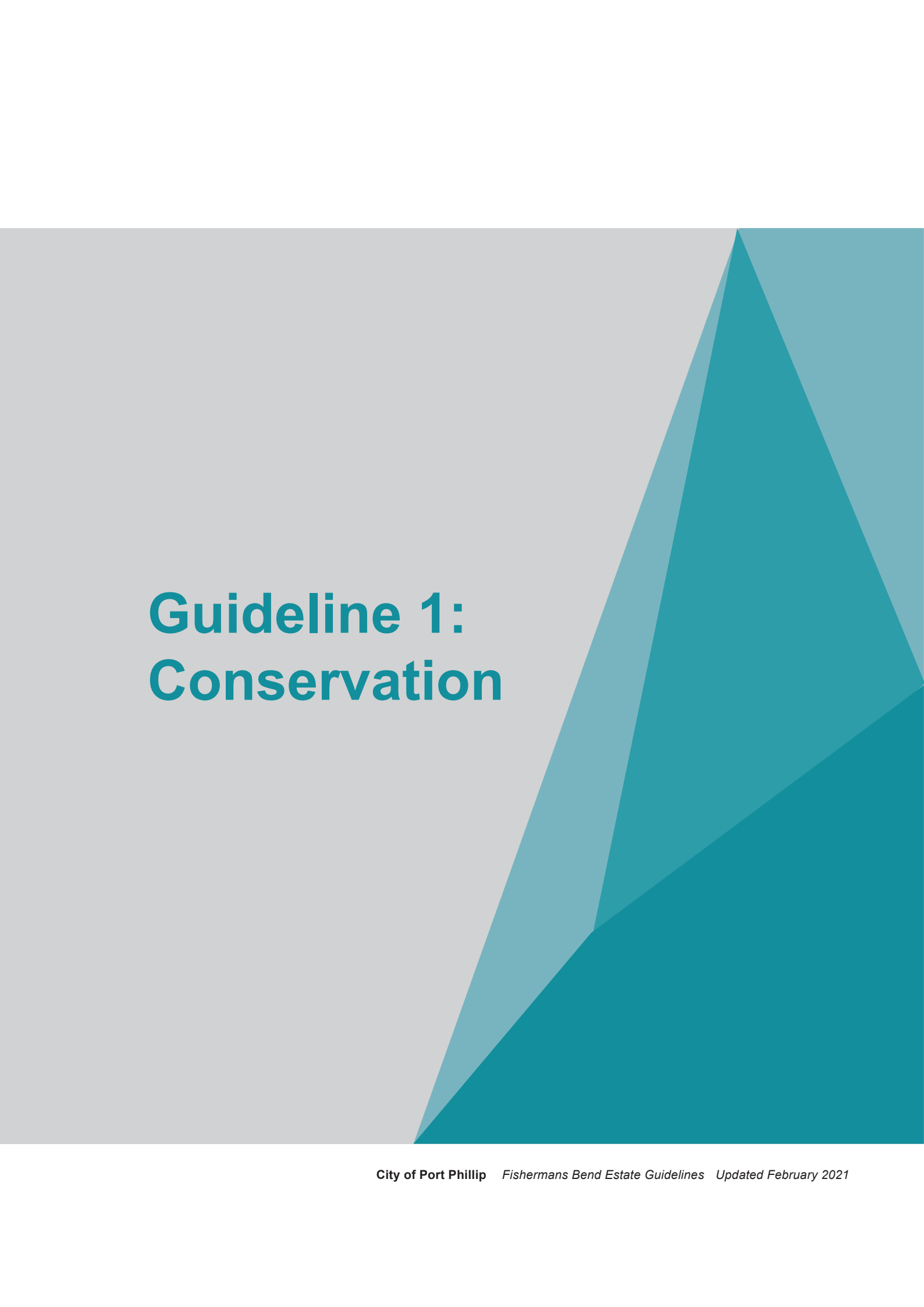

Figure 11. The “Quartets” on the two acre site at 444-478 Williamstown Road.

The background features a large, abstract geometric composition. On the right side, there are several overlapping triangles in various shades of teal and blue, pointing towards the top right. The left side of the page is a solid, light grey color. The text 'Guideline 1: Conservation' is centered vertically on the grey background.

Guideline 1: Conservation

Guideline basis

The original construction details and the materials play an important role in establishing the historic character of the estate.

In order to minimise maintenance, the only painted surfaces in the original dwellings were exposed timber and metal. All other surfaces were natural, including the precast concrete walls. All of the concrete walls have now been painted, presumably initially by the HCV, but most brickwork remains natural. Types of brick used vary from over-burnt (clinker) to pink and cream.

The decoration of the visible external fabric of a dwelling should be consistent with the original palette of materials and finishes used in Fishermans Bend Estate.

General guidelines

- The restoration of original features of dwellings is encouraged.

Roofs guidelines

- The original glazed terracotta tiles on houses should be retained
- The original hipped (concrete dwellings) or gabled (brick dwellings) roofs should be retained

Chimneys

- Retain chimneys where they are visible from the public realm

Gutters, verges and downpipes

- The roof gutters of the concrete dwellings are of a special splayed type. Their downpipes exit from the backs of the gutters with the horizontal arm concealed above the eaves lining. Retention and accurate replacement is encouraged, however, they are no longer commercially available and would need to be fabricated by a sheet metal shop.
- The gutters on gable roofed dwellings appear to have originally been bull-nosed with exposed cranked circular downpipes. This is the pattern that should preferably be used in replacements.
- The eaves of the concrete dwellings are boxed with a splayed fascia, while the eaves of the gabled brick dwellings are raked and projecting with a vertical gutter board. This distinction should be maintained in new works.

Walls and gable ends guidelines

- The gable ends of the single storey dwellings are in continuous brick, while those of the two storey dwellings are sheathed in vertical sawn boards.
- The gable ends of the later porches are sheathed in fibro-cement with a pattern of exposed battens.

Porches guidelines

- Retain original flat-roofed porches or later hipped or gabled porches erected by the HCV.
- Porches similar to those on original dwellings could be reinstated.



Figure 25. The original details of a concrete dwelling. Note the splayed eaves verge and splayed gutter, the eaves boxing, the partially concealed downpipe and the sliding timber windows with horizontal glazing bars set directly in the projecting concrete architrave in which the tracks are located.



Figure 26. Later rendered brick porches on concrete dwellings.

Windows and doors guidelines

- Original windows and doors should be retained and, where possible, the reinstatement of windows and doors in the original form is encouraged.
- If original or later sliding windows are visible from the street and are to be replaced, they should be in a simple form with a pair of sashes reflecting the pattern of the original, either sliding or side hung casement, and with two horizontal glazing bars.
- Timber double hung windows, mostly paired, in many of the brick dwellings, should be retained if possible and/or replaced in similar form, if visible from the street.
- Front doors were simple framed vertical board doors without sidelights or highlights. This pattern should preferably be maintained.



Figure 11. The dwelling to the left of the pair has an HCV porch and aluminium windows. That to the right has its original timber double hung windows and porch (now built in).

Painting guidelines

- Unpainted brickwork should not be painted.
- Neighbours in pairs are encouraged to agree on the same or similar colour schemes for painted surfaces.
- Concrete surfaces should preferably be repainted in pale grey or stone colours, using a matt or slightly textured acrylic paint.
- As a general guide, colours should be kept simple, using only two colours - a dark colour for metal trim including roof gutters and a light colour for timber trim, including windows.
- The gable end vertical boards of the two storey dwellings were probably originally creosote stained. A similar finish should be maintained. Suggestions include modern timber finishes such as fence-coat or deep brown matt acrylic paint.

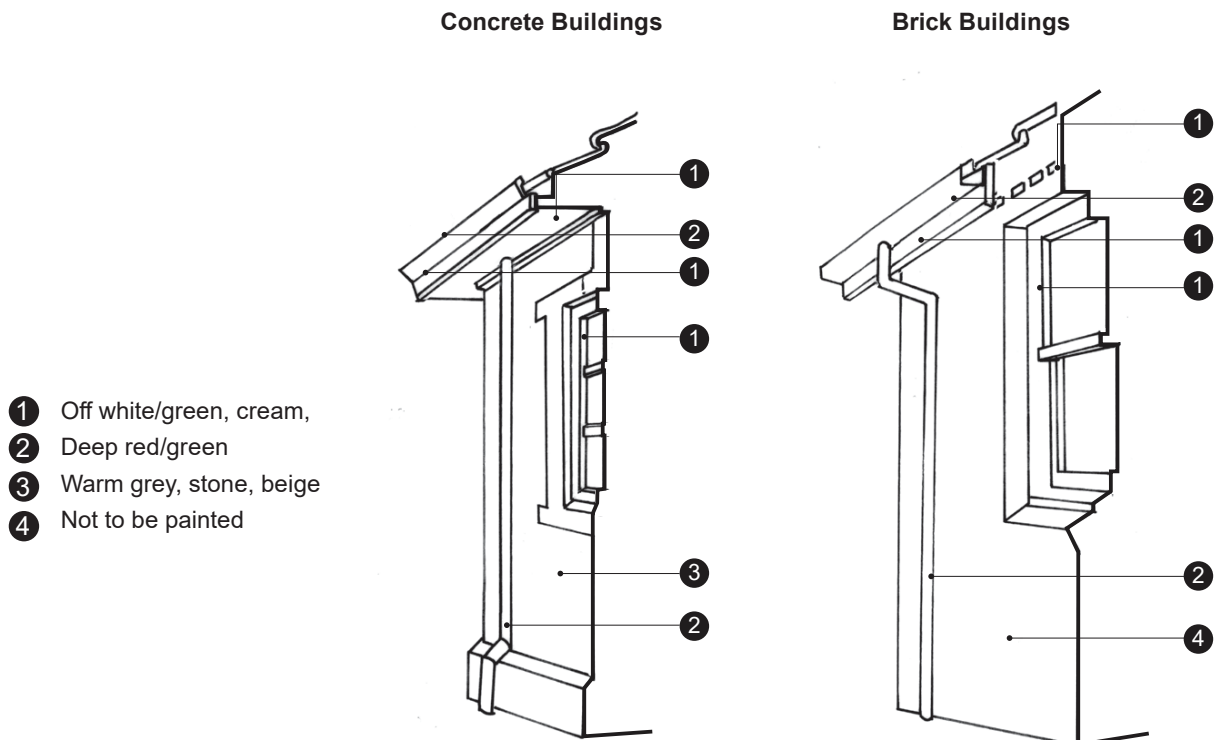
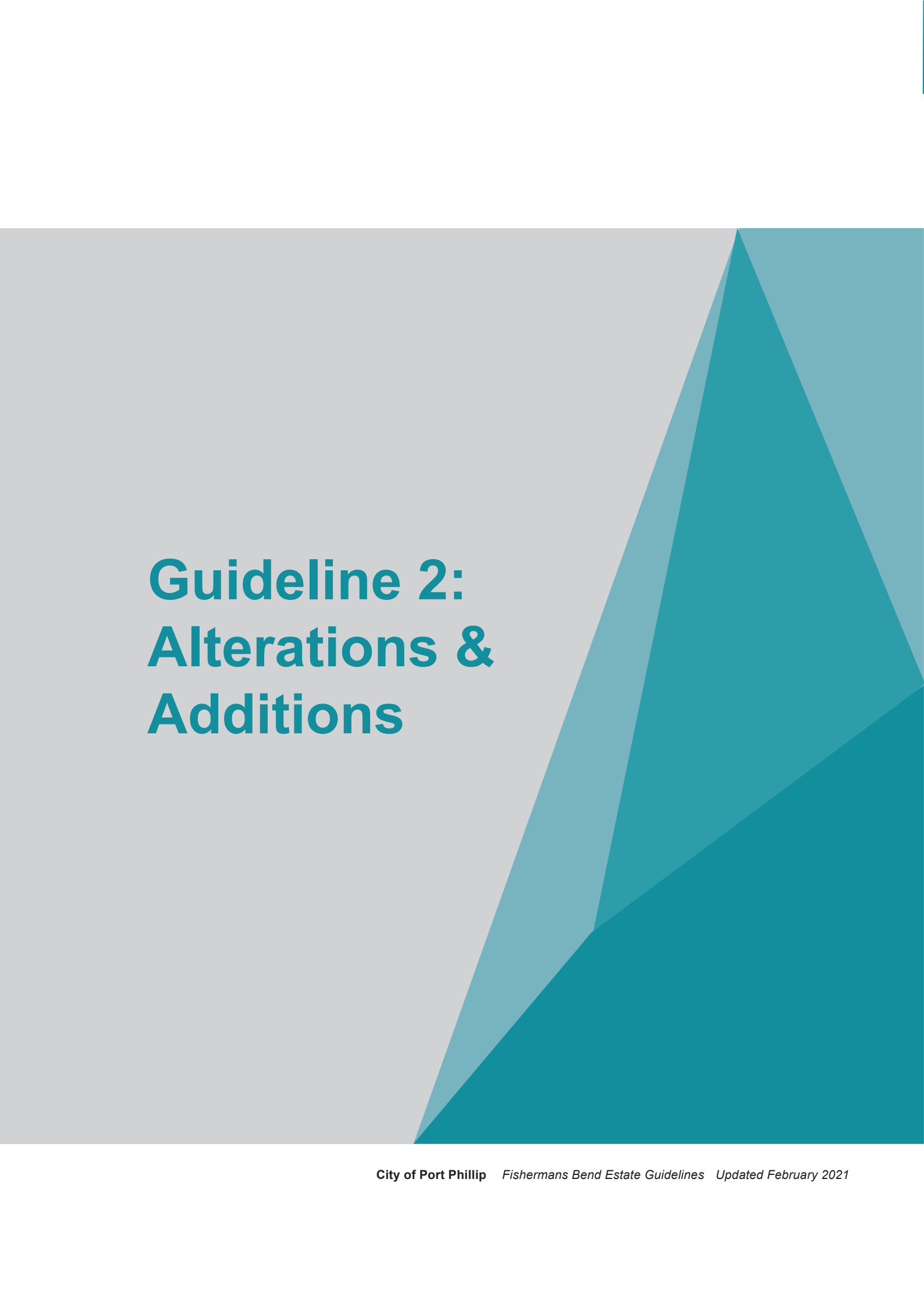

Figure 27. Examples of external decoration surfaces

The background features a large, abstract geometric design. On the right side, there are several overlapping triangles in various shades of teal and blue. The left side of the page is a solid light grey. The text is positioned on the left, overlapping the grey area.

Guideline 2: Alterations & Additions

Guideline basis

The focus of these guidelines is upon alterations and additions that would be visible from the public domain. For the purposes of these guidelines, the public domain is defined as any place within the public areas of Fishermans Bend Estate or the areas around its boundary. The principal views of Fishermans Bend Estate are not generally confined to street widths (as in a typical Port Phillip streetscape setting), but are long views further away, for example, those across the reserves.

The original mix of one and two storey dwellings is considered a key aspect of the significance of the Fishermans Bend Estate. The number and variety of single storey dwellings are also of significance, as is the technology of single storey concrete dwellings. It is desirable that these aspects of significance are protected.

It is of note that Fishermans Bend Estate is as much as four times as dense in composition as typical inter war estates, in that dwellings are roughly only half as wide and allotments only half as deep as in other inter war subdivisions.

In this context, and having regard to the desire of many owners to improve the amenity of the dwellings, it is recognised by Council that second storey additions to single storey dwellings may be appropriate if they are carefully designed in accordance with these guidelines.

General guidelines

Visible alterations and additions to a dwelling should maintain the character of the area and be harmonious with the existing dominant character of the area.

Building form, materials and details

- Visible additions should generally employ similar design forms, materials and details of the original dwellings, but recognisable as a new element.
- For visible additions to concrete dwellings, the suggest wall material is rendered brick or cement sheet, either plain or with an applied sand finished surface.
- The introduction of visually intrusive new elements (for example exposed air conditioners) is discouraged.
- Use materials sympathetic to the existing dwelling.

Scale and siting

- Additions in front of existing dwelling are discouraged.
- Single storey additions to single storey dwellings are encouraged ahead of two storey additions.
- Two storey additions to single storey dwellings should be designed in a manner which allows the character of the original single storey dwelling to remain dominant and legible.
- Two storey additions should be located at the rear of the existing dwelling and not higher than any original two storey dwelling in the Fishermans Bend Estate area.
- Encourage, if possible, where there is a pair of matching dwellings, that both dwellings be extended at the same time and in the same form, to retain visual rhythm and symmetry, particularly when a two storey addition is proposed.

Windows and doors

- Window openings of additions, if visible from the street, should be of similar proportions to those of the existing dwelling.
- New or enlarged window openings in the existing dwelling should be avoided.
- The conversion of original windows to bay windows or doors is discouraged, where visible from the street.

Air conditioners and equipments

- Roof mounted services and equipments should be located where it cannot be seen from the principal street frontage(s).
- Air conditioner and associated equipment should not be visible from the principal street frontages including side streets when on corner sites.

Blinds and awnings

- Fixed awnings or other permanent attachments for sun control should be suitable to the architectural style of the dwelling and designed to be as unobtrusive as possible.

Single storey additions guidelines

Single storey additions to a dwelling should:

- Preferably be at the rear of the dwelling and should not be visible from the street (Refer to Figure 15a).
- If at the sides of a dwelling, be set back at least 1.5 metres from the front wall of the dwelling and the roof should be of noticeably lesser height than that of the dwelling (Refer to Figure 14&15b). In the case of the existing dwelling being two storeys, a single-storey addition at the side also should be noticeably lower than the main roof of the adjacent single storey dwelling.
- Where visible from the public domain (for example, corner sites), have roof form, pitch and materials that is similar to the existing dwelling. Other options, such as a separate roof concealed by a parapet, may also be considered.



Figure 14. A simple gable side addition, possible where there can be a boundary setback.

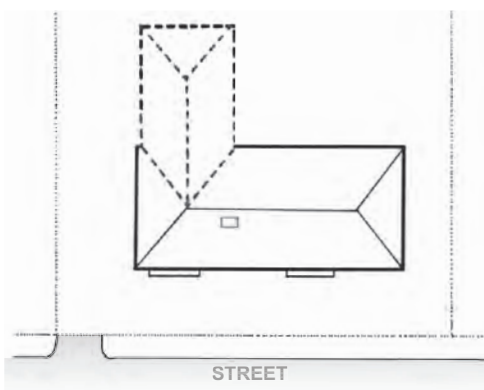

Figure 15a. Preferred location of addition behind existing dwelling

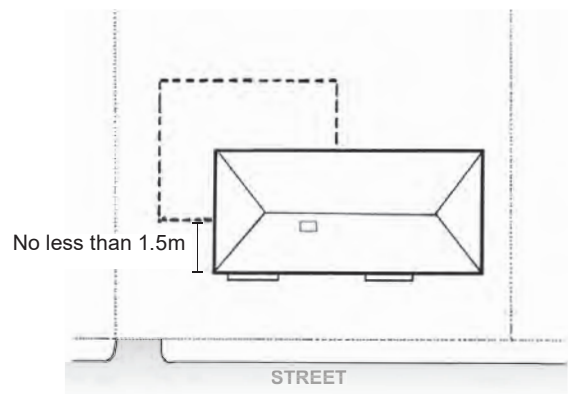

Figure 15b. Alternative location of addition at side of existing dwelling

Two storey additions to two storey dwellings guidelines

As shown in Figures 16 and 17, two storey additions to two storey dwellings should:

- Have walls that do not exceed the height of those of the existing dwelling.
- Have a roof of lesser noticeably and lesser height than the existing dwelling.
- Where visible from the public domain (for example, corner sites), the roof form, pitch and materials of an addition should be similar to the existing dwelling.

- 1 Existing building
- 2 Original chimney
- 3 Primary ridge line
- 4 Possible new building envelope (lower than existing)
- 5 Eaves

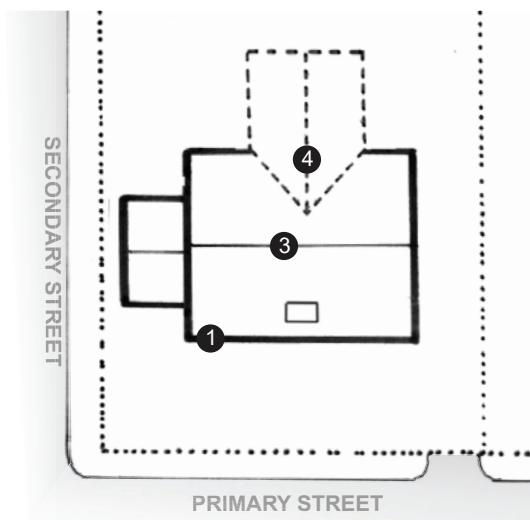

Figure 16. Plan showing two storey rear addition

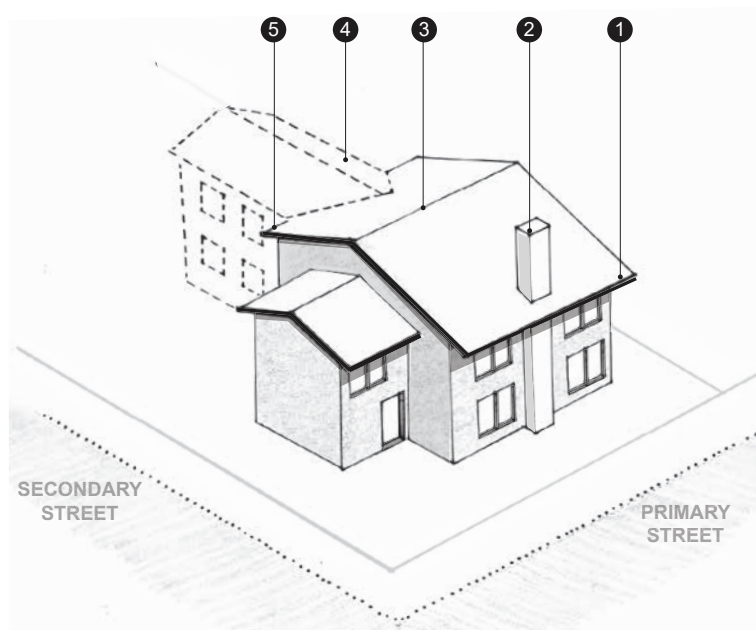

Figure 17. A rear gable addition. This could incorporate a hip roof, if height reduction at the rear was necessary.

Two storey additions to single storey dwellings guidelines

- Small second storey additions, visible from the street, may be supported. The front roof plane shared by the pair should be retained, ie the addition should be sited behind the existing roof ridge line.
- Sheer, two storey high walls on street elevations, or in front of a vertical line taken from the original ridge point on the side wall, are discouraged.
- The height of the visible roof of an addition should be less than the height of the existing roof.
- The sense of the original single storey end gable on any side wall should be retained, for example retain existing eaves or eaves line.

Some suggested two storey additions to middle block single storey dwellings are shown in Figure 18 & 19. These suggestions may not be suitable for corner site buildings.

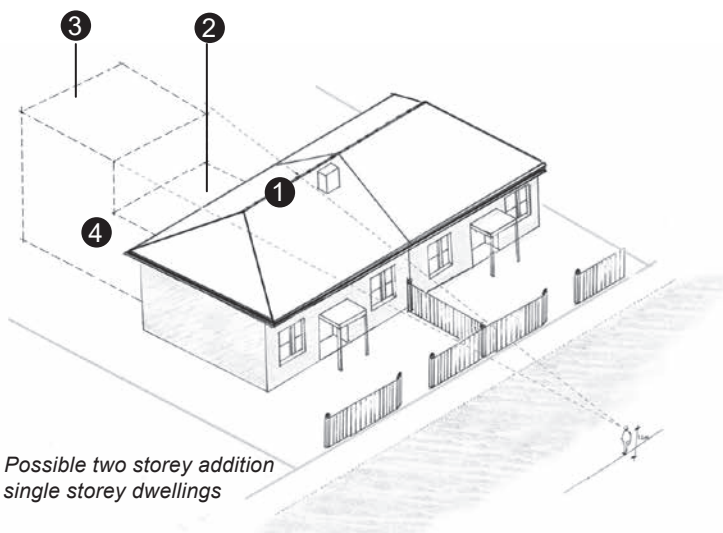

Figure 18. Possible two storey addition to hip roof single storey dwellings

- 1 Existing ridgeline
- 2 Recess the building form to retain the original roof
- 3 Contain building envelope within the sightline from street
- 4 Recess the building form to retain hip roof profile

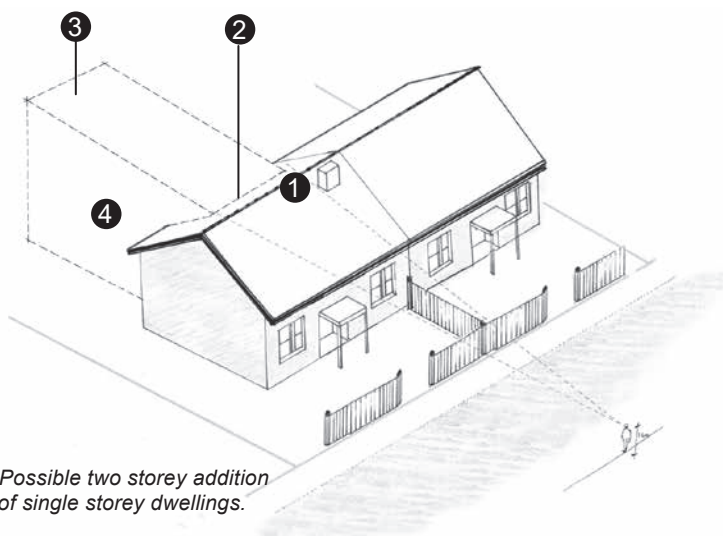

Figure 19. Possible two storey addition to gable roof single storey dwellings.

- 1 Existing ridgeline
- 2 Joining building envelope sitting behind and below the original ridge line
- 3 Contain building envelope within the sightline from street
- 4 Recess the building form to retain gable roof profile

The background features a large, abstract geometric design. On the right side, there is a large teal triangle pointing upwards, which overlaps with a lighter teal triangle. The left side of the page is a solid light grey color.

Guideline 3: Car Parking

Guideline basis

The layout of Fishermans Bend Estate was not designed to accommodate a car on every allotment and garages and carports were generally not provided by the HCV. The later construction of carports and parking areas within front setback areas has impacted upon the garden city character of the area.

Guidelines

- The space in front of a dwelling should be retained as lawn or garden and not used as a space to park vehicles.
- Garages or carports should be sited behind the adjacent front wall of the existing dwelling.
- Carports should be set back 500mm from the front wall of the existing dwelling and should be constructed of the visually lightest framing possible, either in timber or steel.
- Garages, because of their opaque form, should be set back from the front wall of the existing dwelling at least 500mm as shown in Figure 20. Roller shutter doors should be avoided as they add extra height.

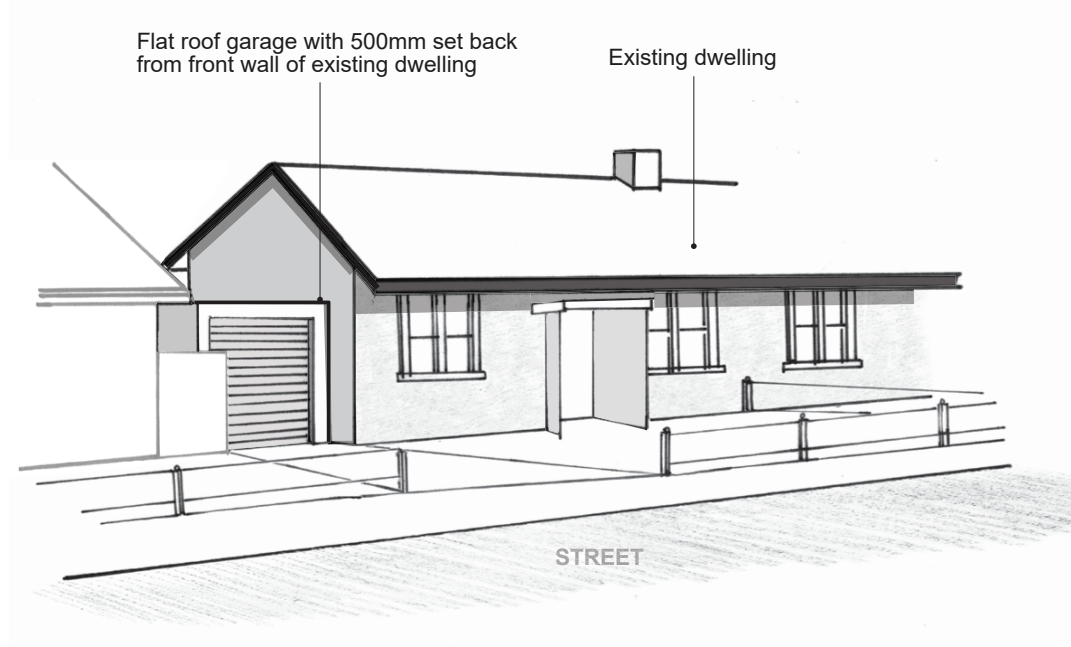

Figure 20. Preferred garage location and design

The background features a large, abstract geometric design. On the right side, there are several overlapping triangles in various shades of teal and blue. On the left side, there is a large, light grey trapezoidal shape that tapers towards the top right, meeting the teal shapes.

Guideline 4: Fencing

Guideline basis

The Fishermans Bend Estate area originally had common fence types for all properties. Those at the front of the dwellings were the low galvanised pipe and chain wire mesh fences (see Figures 21 & 22) that are still quite common.

Most replacement fences are relatively low and are of various combinations of materials, with brick and wrought iron predominant.

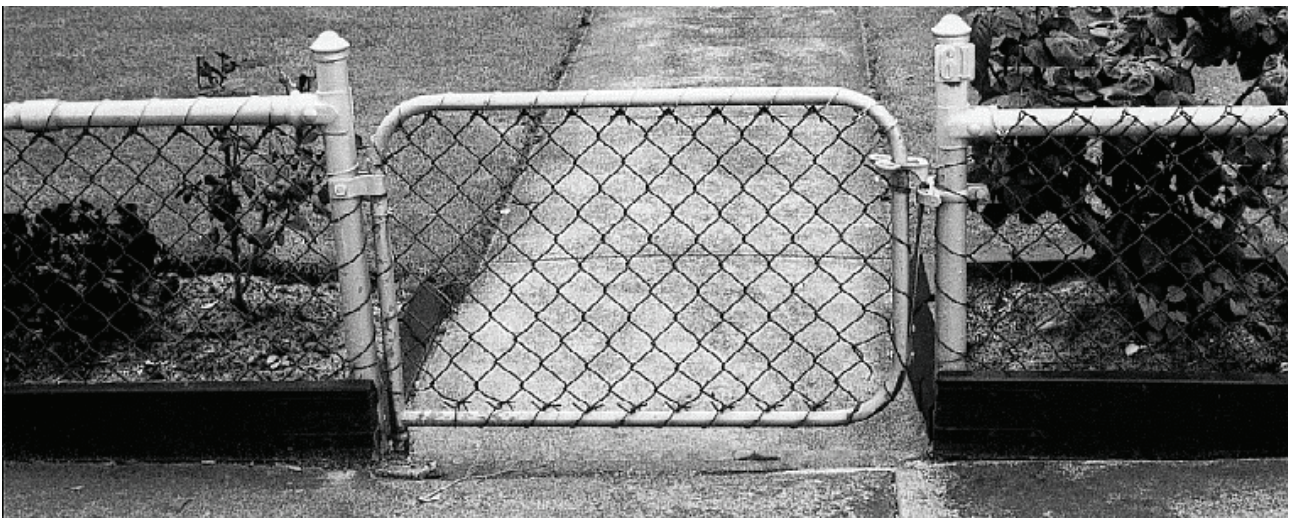

Figure 21. Portion of an original front fence. All fences were constructed like this, although some were higher (for example Howe Parade where the first experimental dwellings were built).



Figure 22. The existing variety of fences, some original, is mostly low.

General guidelines

- Retention of original fences is encouraged.
- Front fences should remain low to maintain the character of the area.

- ① Low front fence (no higher than 1m)
- ② Front fence to match architectural style
- ③ Side fence (no higher than 2m)
- ④ Avoid high, solid front fence

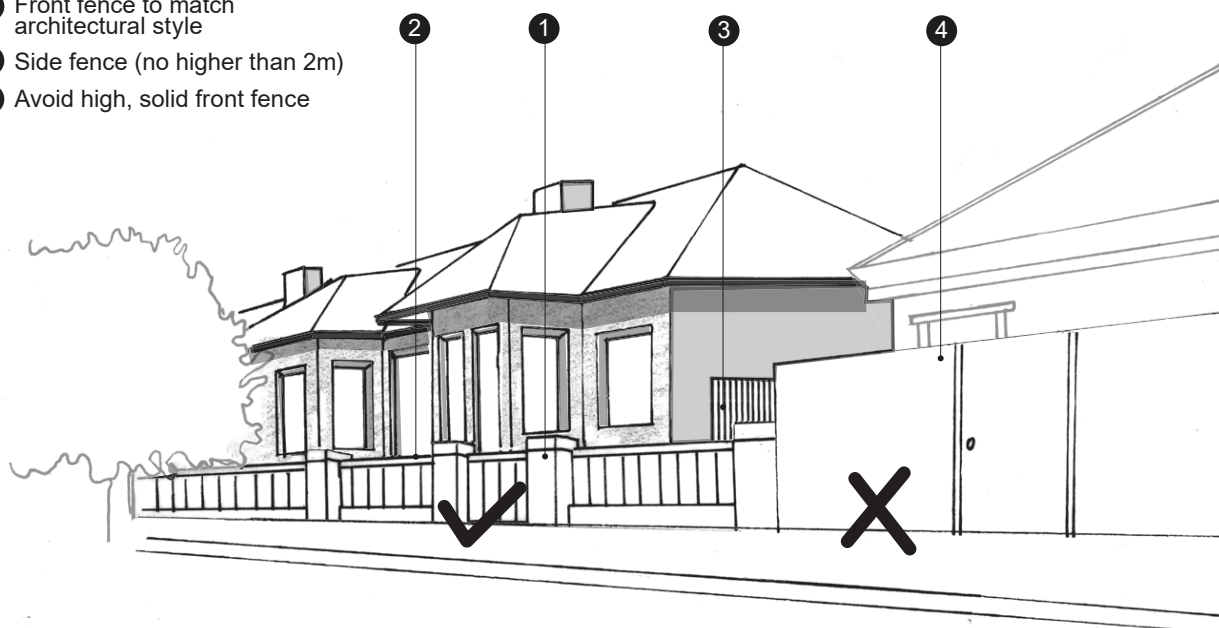

Figure 23. Appropriate and inappropriate front fences

New fence guidelines

- Fences at the front of properties, back to the line of the adjacent front wall, or the front wall of the adjacent property if it is closer to the street, should generally be no higher than 1 metre to the top of the fence panels. Posts could be higher.
- Fences should be of a style that is reasonably appropriate to the period of the estate, ie. Inter-war and immediate post war styles. Some appropriate fence examples are shown in Figure 24.
- Apart from posts or masonry piers, fences should have a straight top.
- For side and rear fences behind the front wall of the dwelling, and from the side boundary to the building, should not exceed 2 metres in height and preferably be of palings.
- The materials of fences should match the materials of the dwelling.

Fencing

1. The low pipe and chain wire mesh fence used originally on the estate. From 600mm - 1000mm high.

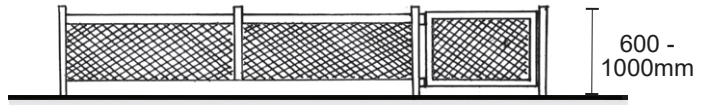

2. Chain wire mesh fixed to a wooden frame. From 800mm - 1000mm high.

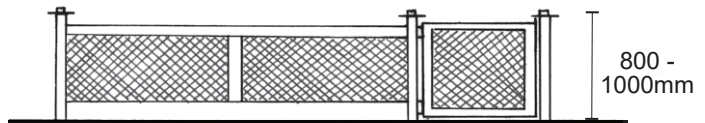

3. Modern weld-mesh fixed to either a galvanised steel or timber frame. 1000mm high.

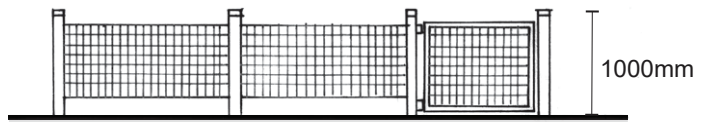

4. A simple brick fence with a chamfered capping brick and wrought iron gate. 600mm - 1000mm high.

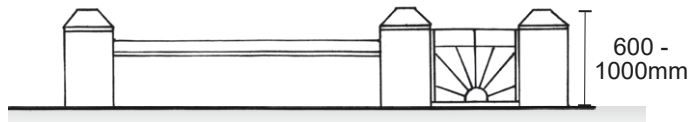

5. A brick fence with a steel pipe rail. 700mm - 1000mm high.

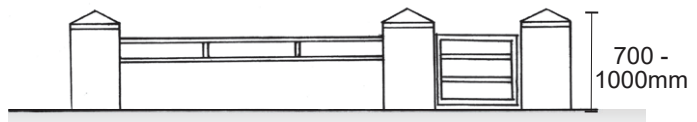

6. A brick fence with a wrought iron top section. Proportion of plinth to height of iron can vary. 700mm - 1000mm high.

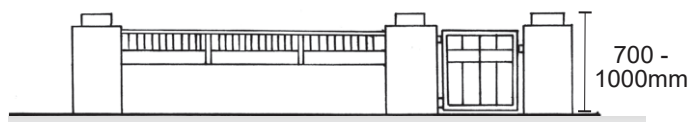

Figure 24. Suggested fence types

The background features a large, abstract geometric composition. On the right side, there are several overlapping triangles in various shades of teal, ranging from a light, almost white-blue to a deep, dark teal. These triangles point towards the top right corner. The left side of the page is dominated by a large, light grey area that tapers towards the right, meeting the teal shapes.

Guideline 5: Front Garden

Guideline basis

The open front gardens are an important feature of the Fishermans Bend Estate that contribute to its 'garden suburb' character. Typical characteristics include:

- Simple and formal layout;
- Lawns contained in border planting;
- Central features and specimen trees;
- Minimal hard paved areas;
- No structures (such as pergolas); and
- Low, transparent front fences.

Guidelines

- Select drought tolerant trees and planting, and to utilise water sensitive urban design measures where possible.
- Avoid replacement of lawn and garden beds with hard paved areas, particularly for car parking.
- Refer to Guideline 4 for fencing.

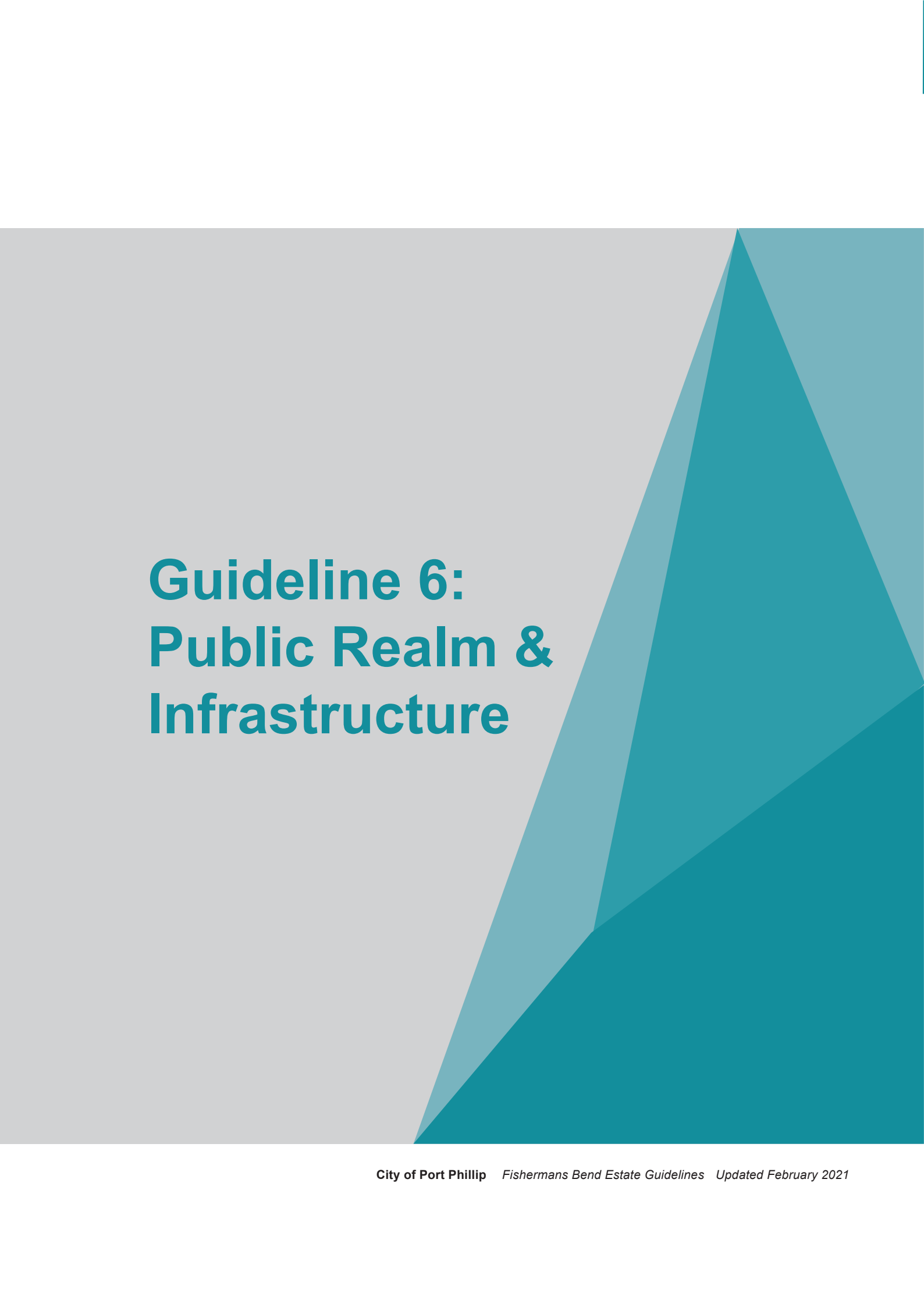
The background features a large, abstract geometric composition. On the right side, there are several overlapping triangles in various shades of teal, ranging from a light, almost white-blue to a deep, dark teal. These triangles point towards the top right corner. The left side of the page is a solid, light grey color. The text is positioned on the left, overlapping the grey area.

Guideline 6: Public Realm & Infrastructure

Application

This applies to roads and road surfaces, kerbs and channels, footpaths, crossovers, nature strips and public open spaces.

Guideline basis

Council, as the responsible authority for the infrastructure of Fishermans Bend Estate, plays its part in the conservation and enhancement of the areas' overall character.

Works within the public areas of Fishermans Bend Estate, including to roads and the public reserves, should be consistent with the forms and materials of the original works, with the minimum modification required to the original layout in order to meet current requirements and standards.

Guidelines

- Any new works that are not part of the original design (such as kerb extensions and parking bays) and repairs should match the form and materials of the original parts.
- Speed humps, if necessary, should be of asphalt.
- Roundabouts, if necessary, should be of minimal size and not significantly alter the original kerb lines.
- Tree planting informed by the original layout should be introduced. Consideration could be given to using species that might have been planted at the time of construction of the estate and that are suitable to the local environment.
- Development of the three major open spaces, Buckingham Reserve, Julier Reserve and the reserve on the Boulevard, should be undertaken to satisfy current and future resident needs and using the original plan as a basis.
- Any new landscaping should achieve environmental outcomes, including water conservation, the inclusion of water sensitive urban design and the provision of fauna habitat.



Figure 13. The existing playground area of Buckingham Reserve (2010).

The background features a large, abstract geometric composition. On the right side, there are several overlapping triangles in various shades of teal and blue, pointing towards the top right. The left side of the page is a solid light grey color. The text 'Guideline 7: Subdivision' is centered in the grey area.

Guideline 7: Subdivision

Guideline basis

The consistent rhythm of pairs of attached dwellings, subdivision pattern and site layouts is critical to the character of Fishermans Bend Estate and should be retained.

Subdivision or consolidation of individual sites into larger lots will threaten the significant rhythm of the subdivision pattern and site layouts.

Guidelines

- Subdivision and consolidation of land is discouraged.



The Dunstan Estate

Griffin Avenue, Southward Crescent, part
Graham Street and part Williamstown Road,
Port Melbourne

Heritage Guidelines

Prepared for
City of Port Phillip
by
heritage ALLIANCE

November 2007

heritage ALLIANCE Conservation Architects and Heritage Consultants
41 Cobden Street, North Melbourne, VIC 3051 Phone: 03 9328 5133 Fax: 03 9328 5144 Email: heritage.alliance@bigpond.com
ABN 23 308 903 866



HERITAGE GUIDELINES FOR ALTERATIONS AND ADDITIONS TO DWELLINGS IN THE DUNSTAN ESTATE, PORT MELBOURNE

CONTENTS

PART ONE: BACKGROUND TO THE GUIDELINES	5
1.0 Introduction	5
2.0 The Extent of the Dunstan Estate	6
3.0 The Heritage Significance of the Dunstan Estate	7
4.0 Important Features of the Dunstan Estate	8
5.0 Current Condition of the Dunstan Estate (2006).....	12
6.0 Application of the Guidelines	13
PART TWO: THE GUIDELINES	14
7.0 Objectives of the Guidelines	14
8.0 Works in Public Areas.....	15
9.0 Additions and Alterations to Dwellings.....	16
10.0 Additions to Single Storey Dwellings	17
11.0 Additions to Two Storey Dwellings.....	19
12.0 Parking, Garages and Carports	21
13.0 Fences	23
14.0 The Dwellings: Construction Details and Materials.....	26
15.0 External Fittings	30
16.0 Landscaping.....	32
17.0 Demolition	33
18.0 Subdivision, Consolidation and Multi-Unit Development	34



ILLUSTRATIONS & DRAWINGS

Figure 1	The Dunstan Estate	6
Figure 2	Type A dwelling (single story).....	8
Figure 3	Two storey Tudor style Type C dwelling	8
Figure 4	Two storey Georgian style Type C dwelling	9
Figure 5	Two storey Cottage style Type C dwelling.....	9
Figure 6	Essential features of the Estate.	9
Figure 7	Desert Ash Tree, used for street plantings.	10
Figure 8	An intact Tudor influenced Old English style dwelling in the Estate	11
Figure 9	Schematic development options showing where additions may be sited. .	16
Figure 10	An acceptable two-storey addition to a single storey dwelling.....	18
Figure 11	An unacceptable two-storey addition to a single storey dwelling.....	18
Figure 12	Plan view of extensions at the rear of diagonally placed dwelling pairs. ...	19
Figure 13	A two-storey addition with the roof set lower than the main roof.	20
Figure 14	A new carport must be set back 1 metre from the front of the dwelling.....	21
Figure 15	A new garage must be set back 1 metre from the front of the dwelling.	22
Figure 16	A new addition must be set behind an existing side porch.	22
Figure 17	An early metal fence - Cyclone steel tube type	24
Figure 18	New woven wire fence on timber framing set to a low height.....	24
Figure 19	Timber fence of simple board pickets with a top rail	24
Figure 20	Simple brick front fence	25
Figure 21	Mid fence between dwellings	25
Figure 22	Front fence in diamond wire	25
Figure 23	Application of colour to dwellings in the Estate	29
Figure 24	Driveway and pedestrian pathways	32

PART ONE: BACKGROUND TO THE GUIDELINES

1.0 Introduction

History

The Dunstan Estate of dwellings was constructed in 1936 for the Premier's Department of the State Government of Victoria to designs prepared by the Victorian Public Works Department. The project occurred as a result of long-term concerns about housing conditions in Melbourne in the early 20th century and various efforts to address the issue, which had become focused on the vacant land of Fisherman's Bend following ongoing Port Melbourne Council pressure since 1906.

The State Bank Estate (Garden City) was constructed for deserving low-income families to purchase dwellings on favourable terms, but had not addressed the real problem of the need for rental housing. The Government was proceeding to appoint the Housing Investigation & Slum Abolition Board (HISAB) in 1936 when, in the attempted coup designed to relieve the political pressure, the Country Party Premier - Albert Dunstan, announced plans for 50 new dwellings to be built in the eastern corner of the intersection of Williamstown Road and Graham Street.

The minority Country Party Government was supported at the time by the Labour Party, hence the need for Dunstan to demonstrate some action to address working class concerns. Dunstan was also under pressure from social reformers, led by Oswald Barnett, who became chair of the HISAB and was responsible for the establishment of the Housing Commission of Victoria and one of its four foundation members.

The Estate was never named but for obvious historical reasons and for simplicity in these guidelines, it is referred to as the *Dunstan Estate*. The designs for the Estate by the Public Works Department under Chief Architect, Percy Everett, continued the theme of the garden city set by the State Bank Estate but reflected the popular eclectic tastes of the 1930's including English cottage, Tudor and neo-Georgian variations of basic types. Forty-six of the fifty proposed dwellings were built, four being omitted at the east end of the Estate where the Housing Commission "Quartets" now stands.

The use of distinctly varied styles and the diagonal arrangement of the sites and dwellings in Griffin Crescent and Southward Avenue are the major innovations of this project. To some extent it addressed concerns about the smallness of sites at Garden City, but otherwise it could be described as "window dressing" for political purposes. The addition of less than fifty dwellings to the housing stock of the metropolis was going to have little impact on the severe shortage of housing available for rental in the inner city – this problem had to wait until the Housing Commission of Victoria was formed in 1938 and began the business of serious dwelling construction at Fisherman's Bend in 1939.

Nonetheless, the Dunstan Estate was the first housing estate built for rental tenancies by the State Government of Victoria.

2.0 The Extent of the Dunstan Estate

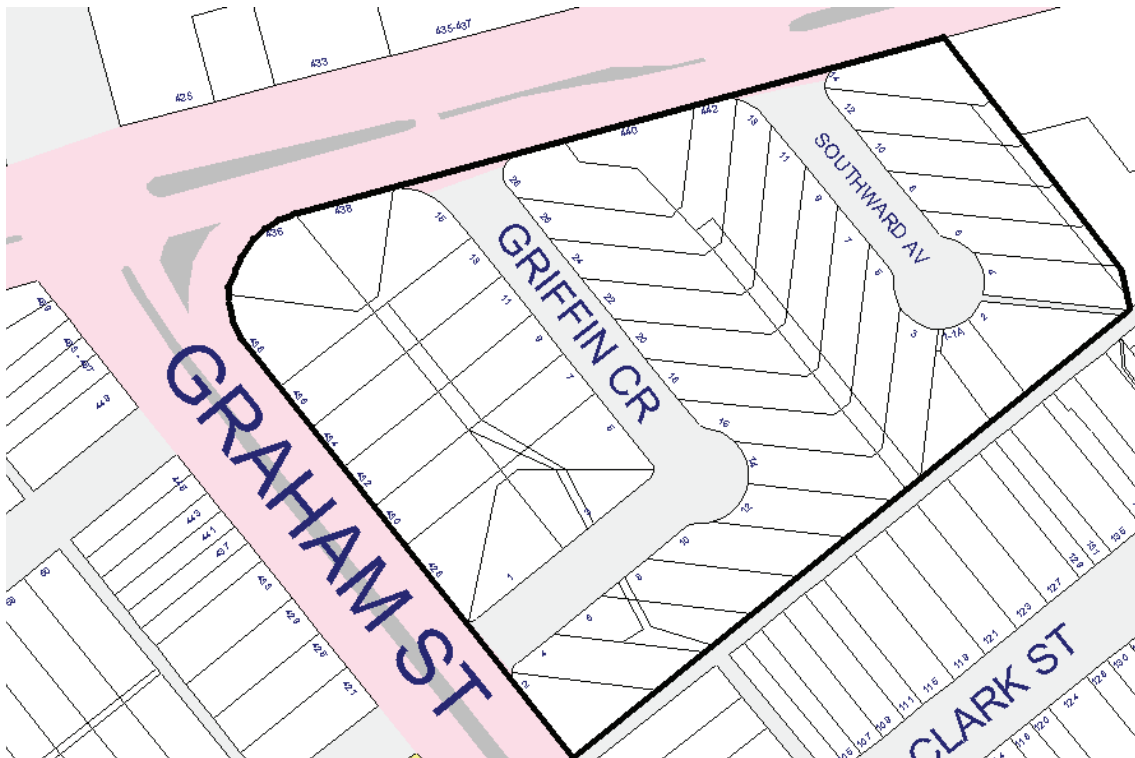

Figure 1: The Dunstan Estate

The properties covered by these guidelines are:

- ❑ 428 - 438 Graham Street
- ❑ 1 - 15 and 2 - 28 Griffin Crescent
- ❑ 1-1A - 13 and 2 - 14 Southward Avenue
- ❑ 436 - 442 Williamstown Road

3.0 The Heritage Significance of the Dunstan Estate

The Dunstan Estate in Port Melbourne, initiated by the then Premier of Victoria, Albert Dunstan, and constructed in 1936 to the designs of the Public Works Department, is of state significance as the first housing built by the State Government for rental rather than for sale.

The historical importance of the Estate lies in its contribution to a political progress towards the formation of a state-wide rental housing policy and its ultimate implementation by the Housing Commission of Victoria. The Dunstan Estate represents a small but important chapter in the attempts of politicians to provide working class housing.

The Estate's layout and collection of dwelling types adds some colour and interest to the essentially grim problem it confronted and its comfortable suburban image is softer than the more regimented designs of the earlier State Bank Estate and the Housing Commission Fisherman's Bend Estate which followed.

The Estate's heritage significance is physically embodied in the following;

- ❑ The layout of the estate and its continuation of the Garden City concepts first demonstrated at the adjacent State Bank Housing Estate in 1926.
- ❑ The unique layout of sites and buildings set diagonally to the street alignment.
- ❑ The integration of attached dwellings into the apparently much grander single composition that lent status to otherwise modest accommodation.
- ❑ The use of fashionable and pleasing designs for basic dwellings to support an image of a caring and capable State Premier who was prepared to tackle the housing crisis.
- ❑ The use of distinct Old English styles to create both ownership status and a variety of appearances for an otherwise standard dwelling type.

4.0 Important Features of the Dunstan Estate

The Estate is built on two streets which have asphalt finishes, a bluestone edge and concrete kerbing and in most places a wide nature strip with trees, concrete footpath, low height fencing, and a generous set back to the dwellings beyond.

The Estate comprises 23 pairs of semi-detached dwellings designed to four layouts:

- Type A of one bedroom (single storey);
- Type B of two bedrooms (double storey);
- Type C of three bedrooms (double storey) and
- Type D of four bedrooms (double storey).

Only two pairs of type A and two pairs of type D were ever built.

The variety in appearance of the dwellings was achieved by varying the façade treatment of each type and they are based on Old English styles popular at the time of construction.

The designs provided two treatments for Type B, three of Type C and two of Type D. In Type C (the most prolific), C1 is inspired by English cottages, C2 is neo-Georgian and C3 is Tudor influenced. The two pairs of dwellings omitted at the east corner of Griffin Crescent were intended to have been Type D.

The eclectic approach and the agreeably fashionable designs of the dwellings were probably a reaction to the much more strict approach to design employed at Garden City.

From the evidence of a number of early woven wire *Cyclone* side fences remaining, it would appear that this type was originally used consistently throughout the Estate for front fences. The existing street tree planting of Desert Ash reflects the popularity of the species at the time.

The most important feature of this small estate is its pleasing architectural and planning character as a close or contained group of dwellings, enhanced by the diagonal siting of buildings on relatively large sites.



Figure 2: Type A dwelling (single story)



Figure 3: Two storey Tudor style Type C dwelling



Figure 4: Two storey Georgian style Type C dwelling



Figure 5: Two storey Cottage style Type C dwelling

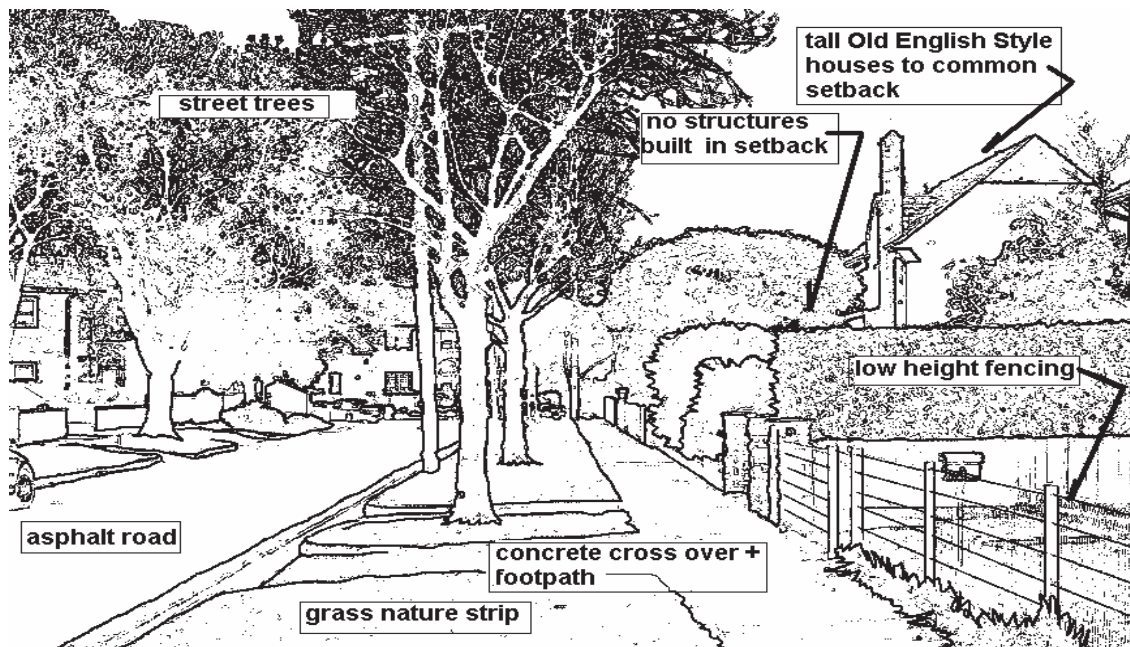

Figure 6: Essential features of the Estate

Individually, the buildings are significant in the way in which they each specifically contribute to the overall character of the Dunstan Estate. This is principally achieved by the recognisable variations in dwelling styles, both obvious and subtle. An example is the bricks used on one type of dwelling which vary from cream to clinker. The specific character of each dwelling therefore needs to be recognised and respected.

Each and every dwelling on the Estate contributes to the heritage significance and character of the Estate. Particular architectural features of note are:

- The scale of the Estate – the buildings, while being small dwellings, combine as pairs to appear more substantial than they are. The design of the single bedroom pairs with a large common gable roof belies the smallness of the individual dwellings.
- The differentiation between the types and their recognizable repetitions.

- ❑ The exposure of one side of pairs of dwellings on diagonal sites.
- ❑ The design of the dwellings as pairs both asymmetrical and symmetrical. The prominence of one entry and virtual concealment of the other in the asymmetrical types enhances this effect. In the neo-Georgian Type C2, the central porch with the symmetrical façade also reads as a single dwelling.
- ❑ The use of contrasting brick and rendered wall surfaces with occasional half timbering to dormer projections.
- ❑ A strong emphasis on chimneys.
- ❑ Consistent use of terracotta tiled roofs.
- ❑ Low front fences that do not obscure the public view of the dwellings.
- ❑ Concrete footpaths, kerb and channel and crossovers with grassed nature strips and asphalt roads.
- ❑ Wide side access to the rear of properties.
- ❑ Mature trees in private gardens, which enhance the English village atmosphere.
- ❑ Consistent street tree planting of Desert Ash in the nature strips, generally at the line of each side boundary (similar spacing to Garden City).



Figure 7: Desert Ash Tree, used for street plantings in Victoria, South Australia and parts of NSW.

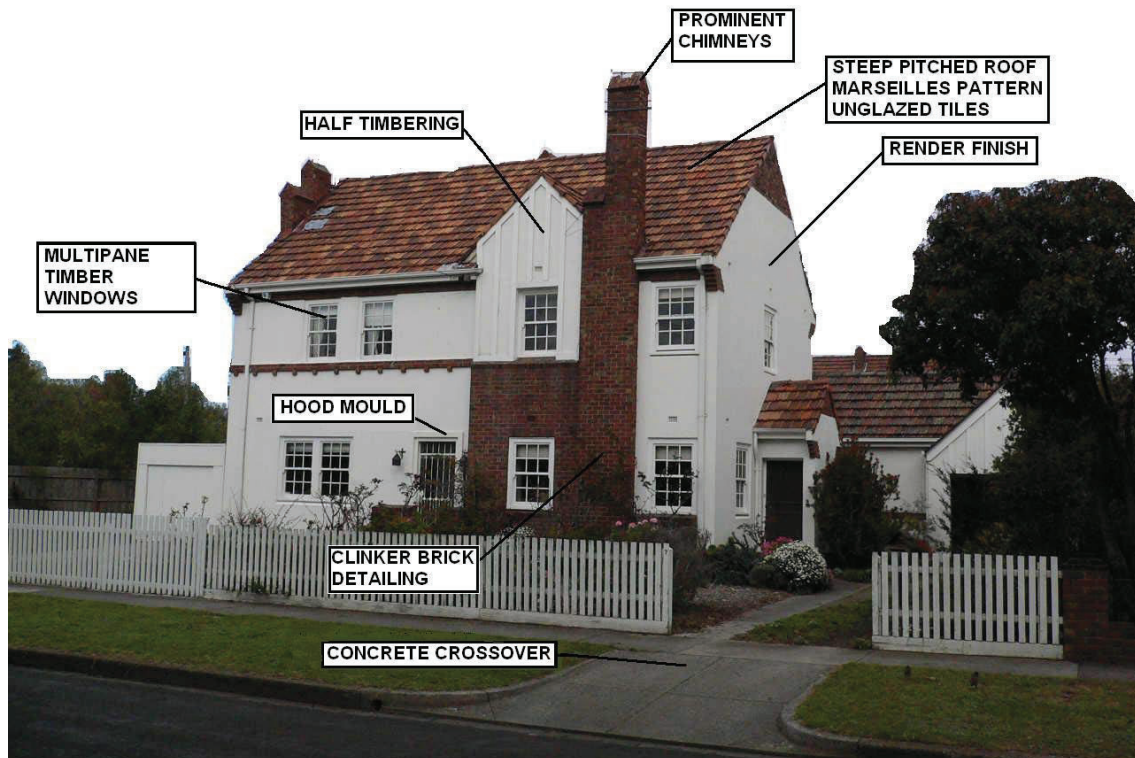

Figure 8: An intact Tudor influenced Old English style dwelling in the Estate, showing some of its important original features.

Interwar Old English style dwellings can be found throughout the suburbs of Melbourne. Those at the Dunstan Estate are a particularly fine collection of mostly two storey dwellings. The Tudor influenced dwellings like the one above have many distinguishing features such as:

- ❑ A high pitched roof accentuating gables and hipped forms with Marseille pattern tiles as the roof covering.
- ❑ Prominent chimneys, chimney backs and often individual chimney pots.
- ❑ Decorative render finishes combined with clinker bricks.
- ❑ Renderwork hood moulds over doors and windows.
- ❑ Tall multi-paned timber framed windows, sometimes using leaded diamond glazing.
- ❑ Half timbering, a feature that makes the style distinctive (half timbering is a combination of exposed timber framing elements with panels of rendering arranged as a decorative feature).
- ❑ Side porches.



5.0 Current Condition of the Dunstan Estate (2006)

The layout and architectural form of the Estate remains largely intact, although a number of planning permits have been issued for alterations and additions since 2000. The highly varied forms and complexity of the original buildings tend to reduce the impact of visible additions, most of which are sympathetic in form and detail and not immediately recognizable when viewed from the street. The wide side setbacks generally allow vehicles to be located towards the rear of the property and there is only one example of a car shelter intruding into the character of the Estate.

There are very few alterations to the fronts of buildings, except for changes to windows and the occasional use of roller shutters over windows. Fence designs tend to be varied. Apart from some properties fronting Williamstown Road, most fences are low and unobtrusive. A number of remnant woven wire fences can be seen at the sides of properties fronting Graham Street. There are only a small number of high impervious fences.

The condition of the dwellings and gardens is generally good. The condition of street trees is varied and some appear to have been removed along Graham Street and Williamstown Road.

Generally, the Estate has matured well and as yet there are no serious alterations to its character and heritage significance. There is an excellent opportunity for the continuing maintenance and further enhancement of its heritage values and the preservation of the Estate as an attractive place to live.

6.0 Application of the Guidelines

The Estate was once fully owned by the Office of Housing and maintenance works were organised through the Public Works Department. Today, most of the dwellings are privately owned and there is a need to set out standards for works and alterations so that changes do not affect the character of the individual dwellings or their contribution to the streetscape. The preservation of the streetscape character of the Estate and the visible individual forms of dwellings is essential for the retention of the Estate's architectural heritage significance.

In contrast with other estates developed for low-income occupants, the Dunstan Estate offers much more flexibility for development without diminishing its essential character. The guidelines therefore have an impact where, for example, an owner may seek to individualise one of a symmetrical pair of dwellings.

In the period since the dwellings were constructed there has been a substantially changed perception of accommodation needs and this has the potential to impact on the character of the Estate. The guidelines seek to direct change in order to support the objective of maintaining the Estate's special heritage values and character.

The Estate is included in a Heritage Overlay (HO2) in the Port Phillip Planning Scheme. As a consequence, a planning permit is required to:

- ❑ Subdivide or consolidate land.
- ❑ Construct a building.
- ❑ Construct, or carry out works (including fences).
- ❑ Demolish, remove or make external alterations to a building or works.

Whilst the Heritage Overlay offers general protection for the character of heritage places, it does not provide specific guidance on conservation management in individual areas such as the Dunstan Estate. These guidelines are prepared in order to define the important elements in the Estate, clarify development issues, and provide advice on conserving existing buildings and managing development in the area.

The guidelines should be used as the first step in the consideration of any development or works that may require a Planning Permit. It should be noted that works which are discouraged by the guidelines are not necessarily prohibited while works which are encouraged are not mandatory, however applications which comply with the guidelines have a greater chance of obtaining a permit.

The guidelines will be considered in the assessment of all buildings and works within the Estate that require a planning permit. Council planning staff should therefore be consulted early in the process to clarify how the guidelines will be applied to the assessment of individual applications.

The guidelines have been prepared by *heritage ALLIANCE* – Conservation Architects and Heritage Consultants, based on draft guidelines prepared by Trevor Westmore (former Heritage Adviser for the City of Port Phillip) in 2000.



PART TWO: THE GUIDELINES

7.0 Objectives of the Guidelines:

These objectives relate specifically to the Dunstan Estate;

- To protect the unique cultural significance and architectural character of the Dunstan Estate.
- To inform the community about the special qualities and significance of the Estate and how that significance is understood through the built fabric and layout of the Estate
- To recognize the changing needs of people living in the Estate and the potential to make alterations and additions to dwellings which do not affect the character of the area.
- To provide a clear and consistent basis for the assessment of planning permit applications, having regard to the heritage significance and important features of the Dunstan Estate.

8.0 Works in Public Areas

The Estate, when laid out, was to a common standard in terms of the detailing of roads (asphalt with bluestone edge and concrete gutters), footpaths (plain concrete pavements), pedestrian easements and the like. It is important to maintain that standard and to intrude on the original arrangement as little as possible.

Council is the majority owner of land in the municipality and has an equal responsibility that when carrying out infrastructure works, it plays a positive role in conserving, enhancing and maintaining the heritage character of the area.

Guidelines

- ❑ Works within the public areas of the Estate, including roads and the public reserves, should be consistent with the forms and materials of the original works with the minimum modification required to the original layout in order to meet current requirements and standards. This applies to roads and road surfaces, kerbs and channels, footpaths, crossovers and nature strips.
- ❑ Road surfaces should be maintained as asphalt with bluestone edging, with concrete gutters and kerbing.
- ❑ Any new works that are not part of the original (including repairs) should match the form and materials of the original parts.
- ❑ Road narrowing should be avoided as it impacts on the planned layout of the Estate.
- ❑ Tree planting conforming to the original layout should be enhanced (maximum of one *Fraxinus oxycarpa*, Desert Ash planted in the nature strip in front of each dwelling).

9.0 Additions and Alterations to Dwellings

The aim of the guidelines is to retain the important characteristics of the Estate which are visible in the public domain. For the purpose of these guidelines, the public domain is defined as any place within the public areas of the Estate, i.e. the surrounding and internal streets, but excluding the rear lane running parallel to Clark Street. Views from the public domain can include both distant views from the ends of the street and close-up views from directly outside the property.

Single or double storey alterations and additions to the rear of a dwelling should be unobtrusive in their view from the public domain. Contemporary additions will be considered where they are sympathetic to the Dunstan Estate and are recessive in their form.

In no case should an addition or alteration physically or visually overwhelm or dominate the original building or its neighbour. Generally, this will exclude large two storey additions unless they are well set back from the front.

It should be noted that because of the diagonal siting of many of the dwellings, the side elevation can be highly exposed to street views. Development of such sites will require special consideration because of their visibility.

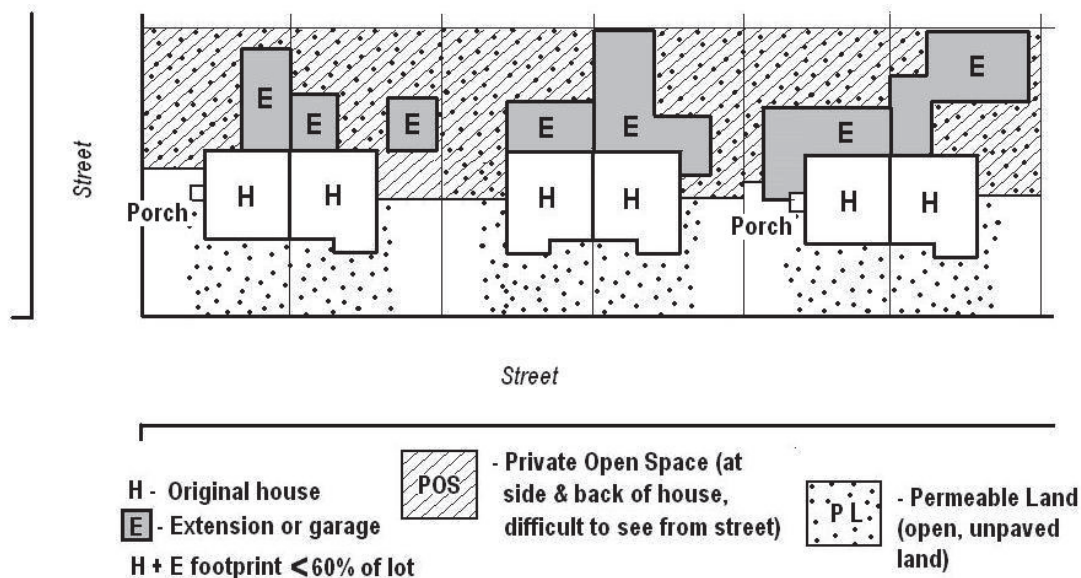

Figure 9: Schematic Development Options showing an example of where extensions for living spaces and garages may be placed to preserve Private Open Space (POS) and permeable areas, without adversely affecting the heritage values of the housing sites.

10.0 Additions to Single Storey Dwellings

Guidelines

Single storey additions to single and two-storey dwellings should be designed to preserve the original major elements of the visible facades of the dwelling. Contemporary additions will be considered where they are sympathetic to the Dunstan Estate and are recessive in their form.

Additions will generally be supported where:

- ❑ They are wholly behind the adjacent front wall of the dwelling by a minimum distance of 600mm or;
- ❑ They are set back behind the original dwelling entry porch or canopy, if it is located at the side of the building.
- ❑ Roof forms, pitches and materials are the same as the main structure.
- ❑ The original chimneys are retained.
- ❑ Window openings, if visible from the street, are of similar proportions to those of the existing dwelling (i.e. if windows are of a vertical arrangement, then new windows should follow that pattern where visible from the street).
- ❑ The original main gable remains dominant and unaltered. A new gable or hip roof to a single storey dwelling may be extended to the side but the height of the new roof should be significantly lower.
- ❑ Use of the roof space to create an additional level will be acceptable provided that the roof is not altered and no new windows, dormers or extensions to the roof are visible from the public domain.

Two storey additions to single storey dwellings will generally be supported where:

- ❑ The extensions are to the rear of the property and are designed to be difficult to see from the public domain.
- ❑ Any visible portions are minor in nature and are views of walling or roofing.
- ❑ Materials used are substantially similar to the existing dwelling.
- ❑ The overall footprint of the extension is less than the existing building.
- ❑ The development is contained within a 10 degree development line which extends from the front gutter of the single storey dwelling as per Figure 10 below.

Contemporary additions will be considered where they are sympathetic to the Dunstan Estate and recessive in their form.

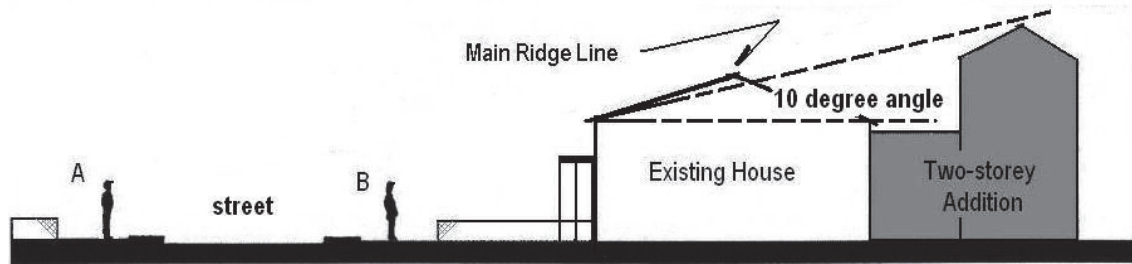

Figure 10: Side view of a two-storey addition to a single storey dwelling may be partially visible in distant views (eg to person A) but should be contained within a 10° building envelope established from the front of the dwelling and using the gutter line as the base line. The addition should be almost wholly invisible to person B.

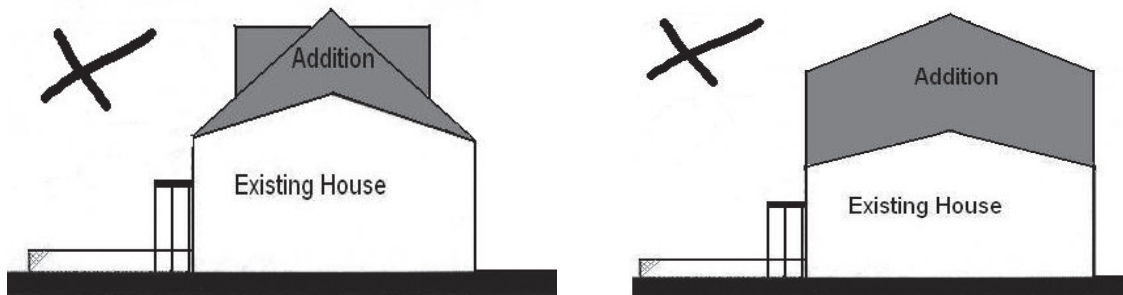

Figure 11: Side view of an unacceptable two-storey addition to a single storey dwelling. These forms change and dominate the roof of the original dwellings.

11.0 Two Storey Additions to Single and Two Storey Dwellings

Guidelines

Two storey additions to single and two storey dwellings may be permitted if:

- ❑ They are sited to the rear of the existing dwelling.
- ❑ They are set back behind the major original roof form. In some cases a building may be less exposed to the public view. In this case a two-storey addition may encroach to half the depth of the original dwelling (refer to Figure 12).
- ❑ The roof is of noticeably lesser height than that of the original dwelling.
- ❑ The walls of the addition do not exceed the height of those of the existing dwelling.
- ❑ Roof forms, pitches and materials are the same as the main structure.
- ❑ The original chimneys are retained and unaltered.
- ❑ Window openings visible from the street are of similar proportions to those of the existing dwelling.
- ❑ Any new dormers in the roof space are sited to the rear (refer to Figure 15).
- ❑ Contemporary additions will be considered where they are sympathetic to the Dunstan Estate and are recessive in their form.

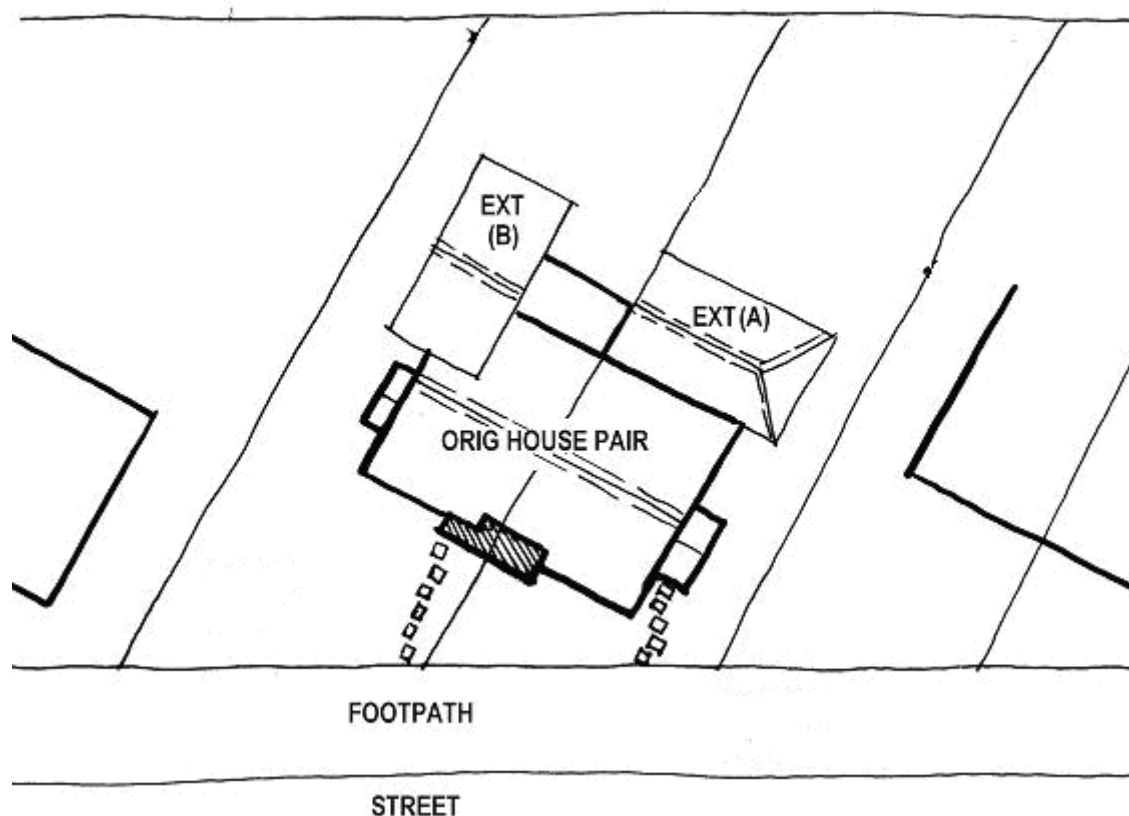

Figure 12: Plan view of extensions at the rear of diagonally placed dwelling pairs.

A two storey extension on a diagonally sited dwelling pair may be behind the main roof form of the dwelling (Ext A) or may encroach to half the depth of the original dwelling (Ext B).

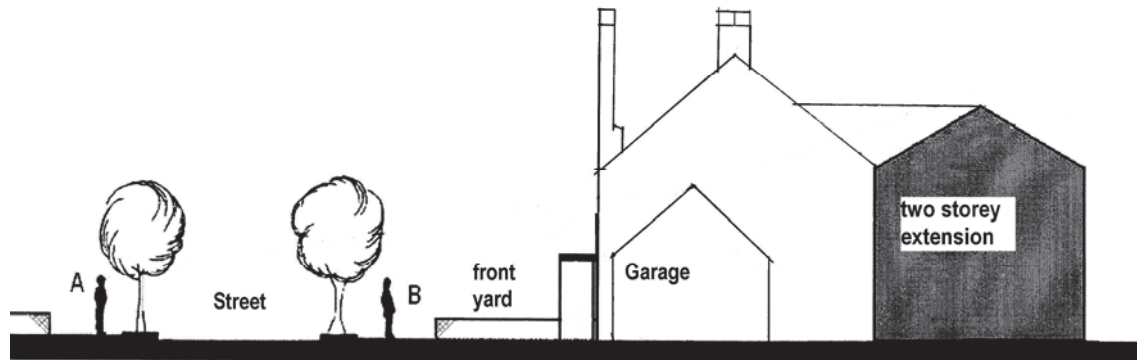

Figure 13: Side view of an acceptable two-storey addition to a two storey dwelling with the roof set lower than the main roof. If the new roof is visible it should be finished in Marseilles terracotta tiles to match the original roof.

12.0 Parking, Garages and Carports

The layout of the Estate has allowed for the parking of motor vehicles off the two main streets at some, but not all, of the dwellings. There is a laneway running parallel with Clark Street from which some off street parking can be introduced. No original garages appear to have been built in the Estate.

New garages and carports fall under the same policies as single storey additions. New built structures should not be built in the front yards of these dwellings.

Guidelines

Parking of cars, and construction of garages and carports should address the following guidelines:

- ❑ New driveways to uncovered parking, carports or garages may be permitted provided that the proposed crossover does not coincide with the location of street trees and a suitable distance is provided between the edge of the crossover and the street tree (in accordance with Council requirements).
- ❑ New driveways and crossovers should be constructed in uncoloured concrete and tracks should be used wherever possible to minimise their impact.

Garages and carports may be permitted if:

- ❑ They are sited behind the adjacent front wall of the dwelling by a minimum of 600mm.
- ❑ They are set back behind the original dwelling entry porch or canopy if this original feature is located at the side.
- ❑ Carports (an open structure) are designed to reflect a pergola type construction, or are built in similar materials and forms to that of the dwelling. Carports including their roof eaves should not be built forward of the front wall of the dwelling.
- ❑ Garage roofs at the frontage reflect the roof pitch of the main dwelling and are finished with terracotta Marseilles pattern tile. Garage doors should not be roller shutters but may be tilt up doors with vertical timber or metal cladding.

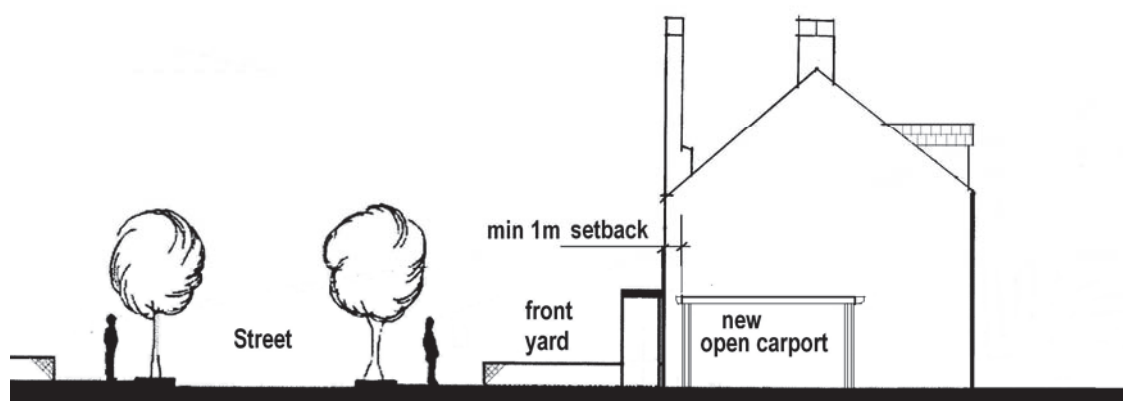

Figure 14: Side view – a new open carport must be set back at least 1 metre from the front façade of the dwelling.

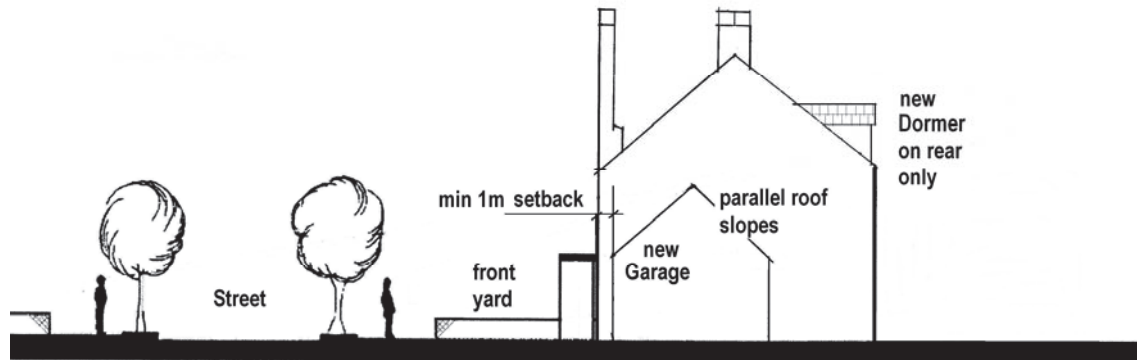

Figure 15: Side view – a new garage must be set back at least 600mm from the front façade of a dwelling. Roofs must be parallel with the slope of the existing roof and use the same roofing material. Any new dormers in roof spaces must be at the rear only.

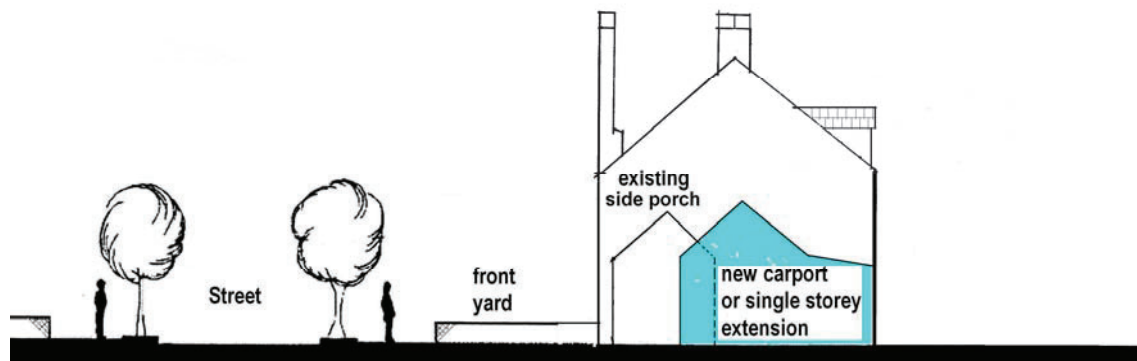

Figure 16: Side view – a new addition used as a carport, garage or dwelling space must be set behind an existing side porch. Roofs must be parallel with the slope of the existing roof or porch and use the same roofing material.

13.0 Fences

There is little evidence of the Estate's original fences and it may be that very few were constructed. The earliest identifiable type is a cyclone wire and pipe rail fence. It is known that in other housing estates very simple horizontal plank fences were constructed as an interim measure.

Many of the existing fences appear to have been constructed in the 1950's in brick as well as brick and wrought metal work. More recently paling fences of various designs have been introduced along with high brick walls.

Most replacement fences now found in the Estate are relatively low and use various combinations of brick and wrought iron. To maintain the character of the Estate, front fences should remain low and the materials should be in character with the materials of the Estate. Inter-war styles are highly appropriate.

Guidelines

New fences may be permitted if:

- At the front of the property (including the side fences in the dwelling frontage), they are no higher than 1.2 metres to the top of the fence panels for transparent/diamond wire fences and 1 metre to the top of the fence for brick fences. Posts may be higher.
- The style of fence is reasonably appropriate to the period of the Estate, i.e. Interwar styles using masonry or wire between steel tube posts or timber posts with steel tube rails. Decorative woven wire and diamond woven wire are preferred.
- Apart from posts or piers, fences have a straight top and are not scalloped.
- Side and rear fences behind the front wall of the dwelling and from the side boundary to the building do not exceed 2 metres in height and are preferably of palings.

Front timber fences, including pickets, are generally inappropriate. Side and rear fences may be timber. Some acceptable examples are shown in the illustrations overleaf.

It should be noted that fences and walls of any reasonable height are ineffective in providing useful acoustic protection on major traffic routes – double-glazing the windows facing the road will be more effective.

Residents seeking greater privacy should use landscaping rather than high solid fences or walls.



Figure 17: An early metal fence – Cyclone steel tube type (acceptable)



Figure 18: New woven wire fence on timber framing set to a low height (acceptable)



Figure 19: Timber fence of simple board pickets with a top rail (acceptable)

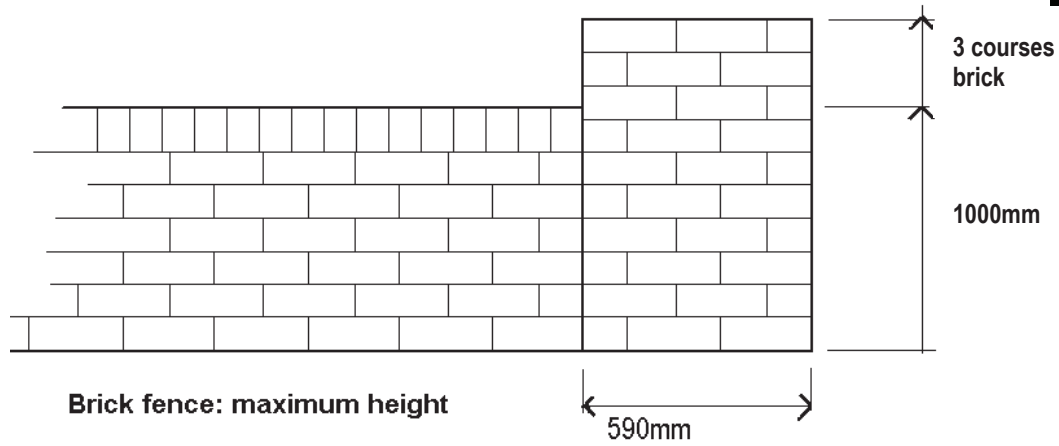

Figure 20: Simple brick front fence with bricks of similar colour and size to the clinkers of dwellings. Maximum height 1000mm.

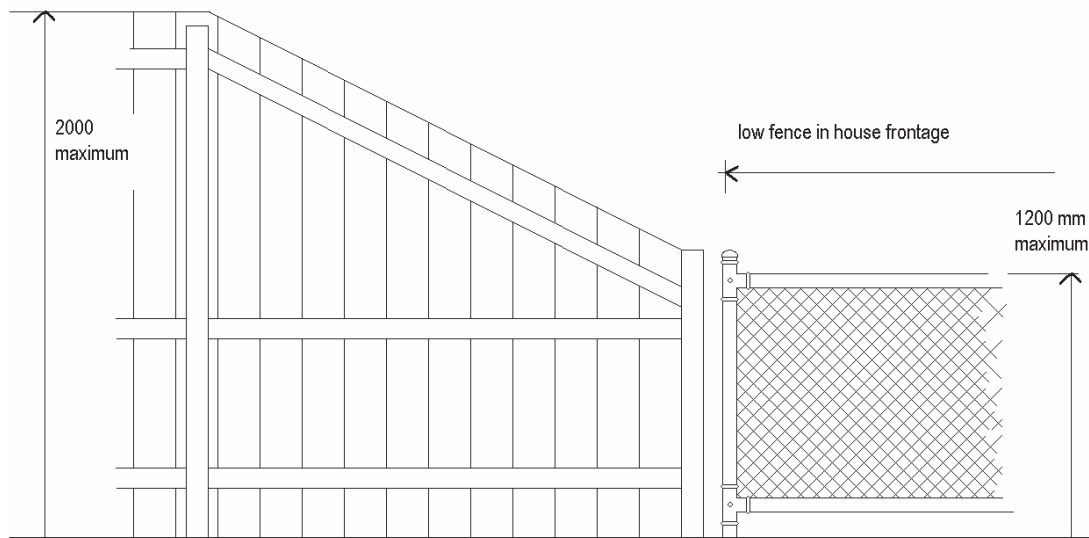

Figure 21: Mid fence between two dwellings with the solid timber fence starting behind the façade of the dwelling and the lower transparent fence in the front yard

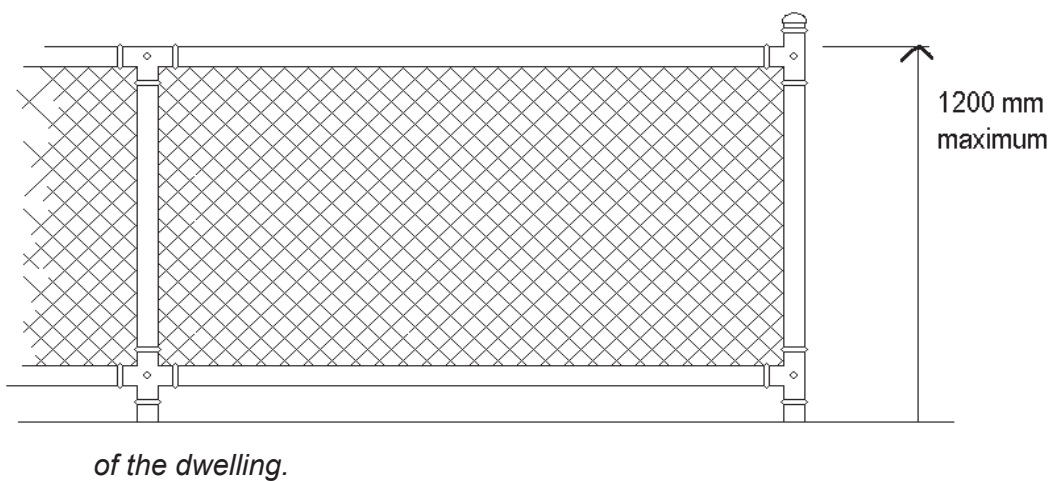

Figure 22: Front fence in diamond wire. Maximum height 1200mm.

14.0 The Dwellings: Construction Details and Materials

The original construction details and materials play an important supporting role in establishing the historic character of the Estate and it is important that the pattern of varied materials is not altered. The use of similar materials and details in the visible parts of new work and in restoration of the original features of dwellings is therefore encouraged.

The Estate uses materials common across all the dwellings. It is the placement of those materials which make the dwellings different from each other but maintains the visual cohesiveness of the Estate.

The restoration of missing original materials and details is encouraged. The use of compatible materials and detail is also encouraged on new additions which are partially visible in the public domain.

Guidelines

14.1 Roofs

Roofs of all dwellings are of Marseilles pattern terracotta tiles of a subtle colour mix. The same materials and colour mix should be used for repairs and for additions. Dark colour tiles, glazed tiles, concrete tiles and tiles not in a Marseilles pattern are inappropriate and are not encouraged.

14.2 Chimneys

Chimneys stacks above the roofs are an important part of the design of many of the dwellings and form important elements of their elevations. All externally expressed chimney features must be retained.

14.3 Roof Gutters, Verges and Downpipes

The roof verge details of dwellings vary. The existing pattern on the original building should be employed in new works. Bullnosed gutters are the standard for the Estate and other types should be avoided. Downpipes should be circular in section.

Plastic, aluminium and Colorbond squared gutters are inappropriate and are not encouraged.

14.4 Walls

Wall treatments vary between the dwelling types – bricks vary in colour from cream to over-burnt (clinker) while Type B1 is wholly rendered. Some dwellings combine both rendered and brick wall surfaces. These distinctions must be retained in all alterations and additions to dwellings.

- The pattern of wall treatments used in the original dwellings should be applied in any new works which create habitable space. This will mean that similar bricks (often second hand) may need to be purchased.
- The walls of new work should generally match those of the existing dwelling, although slight variations in brickwork will be inevitable.

14.5 Porches and Entries

The original porches and entries to the dwellings also vary considerably in form, from the coupled central porches of the neo-Georgian pairs (Type C3) to the basic side entry doors with a small canopy on the English cottage type (Type B1) and others.

The patterns of porches and entries are critical to the design of the pairs.

- ❑ The original porches should be retained in all cases.
- ❑ Modest alterations and additional elements such as extensions of canopies may be acceptable, but only to unprotected doors that are more or less concealed at the sides of dwellings.
- ❑ The use of transparent screen doors at porch entries is acceptable, however glazed or solid doors are inappropriate and are not encouraged. Screen doors should be of a dark colour.

14.6 Windows and Doors

Many, but not all, of the original timber double-hung multi-pane windows of the Estate have been replaced. While this does not significantly reduce the heritage values of the Estate, it does diminish its character. Retention of the existing multi-pane windows and reinstatement of those windows which are missing (where they are visible in the public domain) is encouraged.

- ❑ Where non-original windows are to be replaced, the preferred option is that they revert to their original form and detail. This is important if the windows are visible in the public domain.
- ❑ Alteration to the size of window openings in the front facades of dwellings will not be acceptable. New or enlarged windows and bay windows are not acceptable at the front of the dwelling.
- ❑ Alteration to windows in the side facades of dwellings may be permitted provided that the proportions of the new windows relate to existing windows.
- ❑ Front doors are generally not exposed. Retention of original doors is encouraged, but if the door is not visible from the street, it may vary in form.
- ❑ The conversion of windows to doors is discouraged on the front and side elevations.
- ❑ Fly or security screens, if added, should be of a simple pattern, preferably painted in a colour matching the window frames.

Where noise attenuation is an issue, double-glazing is encouraged. This does not require a planning permit if the pattern of the existing window glazing is not altered, and the double-glazing of windows (which may be in the form of inward opening casements) occurs on the inside of the existing windows.

14.7 External Finishes

The general character of the Estate relies on the use of contrasting materials. Some dwelling types have uniform wall finishes of brick or cement render, but it is the types with varied surfaces that lift the visual character of the Estate.

Given that the dwelling pairs were designed to appear as one building, it is important that adjacent owners do not attempt to individualise their side as this may result in an artificial differentiation between parts of the pair. Owners should attempt to achieve a common solution for the treatment of pairs, particularly in the use of finishing schemes. The following guidelines should be observed:



- ❑ In no circumstance should unpainted brickwork be painted. It is recommended that any previously painted brickwork have the paint removed (by high pressure water methods or chemical methods, not sandblasting).
- ❑ Rendered surfaces should ideally be repainted in pale grey or stone colours, using a matt or slightly textured acrylic paint.
- ❑ Neighbours in pairs are encouraged to agree on the same or similar colour schemes.

14.8 Colours

The following general approach should be used as a guide for colour selection.

1. Roof Gutters Should be painted in a dark colour. Deep reds or deep greens or red-browns would be most appropriate (refer to area 'D' in Fig. 23).
2. Fascias and Eaves Should be painted in a colour ranging from cream to light stone (refer to area 'L' in Fig. 23).
3. Rendered Surfaces Should be painted in characteristic render colour and should not be painted if in good condition (refer to area 'RC' in Fig. 23).
4. Brickwork Brickwork should never be painted. If brick walls have already been painted, the removal of paint by high pressure water or chemical means is recommended. Brickwork should never be sandblasted.
5. Half Timbering Half timbering was probably originally stained. The use of opaque timber coats to replicate natural stained timber is recommended. The timber should contrast with the rendered background.
6. Windows The original dwellings probably used two colours on windows. Use of the dark trim colour as for roof gutters is recommended for window frames. The moving parts (i.e. the sashes) should be painted in a contrasting light colour, as should fascias and eaves (refer to areas 'D' and 'L' in Fig. 23).
7. Exposed Doors Should be painted in the dark trim colour. Doors under porches should be painted a light colour.
8. Screen doors Should be painted in a dark colour.
9. Downpipes Should be painted to match the render colour on the wall (refer to area 'WC' in Fig. 23).

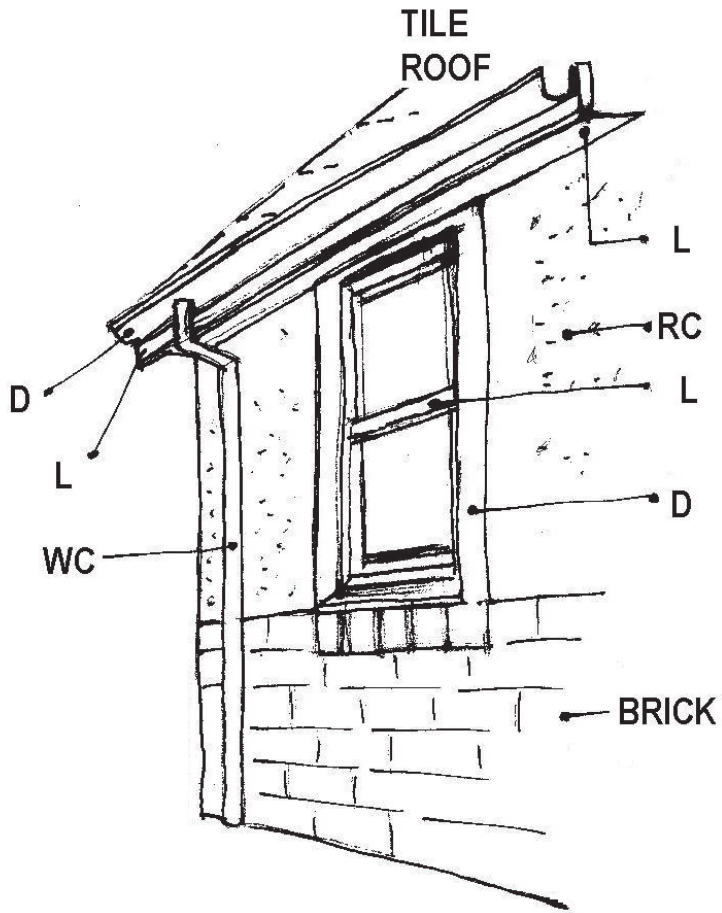

D – dark trim colours for gutters and outer window frames

L – lighter colours for barges, eaves and inner window frames

WC – render colour (wall) for downpipes

RC – render colour (wall)

BRICK – unpainted

Figure 23: Application of colours to dwellings in the Estate.

15.0 External Fittings

External elements should be located so they are substantially invisible in the public domain. This will mean that most new fittings will either be wholly to the rear of the property or in the case of pipes, cables and security screens, the works will be internal.

Guidelines

The following guidelines should be addressed in any proposal to add external elements:

15.1 *Solar Hot Water and Solar Cells*

Solar panels should either be wholly hidden on rear roof slopes or be on subsidiary roofs where they are not apparent in the streetscape.

They should not be on the front roof slope of the dwelling

15.2 *Satellite Dishes*

Satellite dishes should be on rear roof elements. Satellite dishes must not be on the front roof or chimneys or attached anywhere that makes them apparent in the streetscape.

15.3 *External Cabling, Ducting and Pipes*

External ducting, pipes and cabling should not be on the portions of the dwelling visible from the street. This applies to cabling for television, service pipes for water and sewerage, and air handling ducts. Such cables and pipes may be placed externally on the rear of the dwelling.

15.4 *Pergolas and Vergolas*

Pergolas and Vergolas® should not be attached to the front façade of the dwelling or be constructed in the front setback between the fence and the dwelling frontage.

Depending on the degree of visibility and size, they may be permitted to the rear or sides of the dwelling.

15.5 *Sunblinds*

Sunblinds and awnings (temporary and permanent) should compliment the character of the dwelling and should be designed to be as unobtrusive as possible.

External sunblinds can be simple pull-out striped canvas shades.

15.6 *Screens and Security Grilles*

Electric metal shutters should not be installed on the side or front windows of the dwelling. They may be installed on rear windows where not seen from the street.

Timber shutters may be permitted on windows provided they serve a functional purpose, i.e. the shutters should be fully operable. False shutters which clearly could not cover the window and serve no functional purpose are not acceptable. It should be noted that the neo-Georgian dwelling-pairs were originally intended to have timber casement window shutters on the upper floor and original shutter clips remain on some of these designs.

Security grilles should be installed inside windows that can be seen from the street. Grilles may be installed externally where the window is obscured in the view from the street.

15.7 Air Conditioners and Air Package Units, ducted heating furnaces

Air conditioners, air package units and heater furnaces should not be visible from the street. Air package units may be located on rear roof slopes and below the ridge lines.

Air conditioners, fan units and condensers and furnaces may be located:

- At the rear of the dwelling.
- At the side of the dwelling, as long as they are more than halfway back from the front of the dwelling. Fan units and furnaces must not be at the dwelling frontage.

16.0 Landscaping

A planning permit is only required for landscaping purposes where a tree is subject to specific controls, such as a Heritage Overlay, or where buildings and works are required, such as the construction of a pergola. The guidelines for Landscaping are included for those that wish to plant in the traditional manner.

The Estate was established with very simple features, primarily lawn and simple uncoloured concrete paths. Planting out (apart from street trees) was essentially a task of the owner. The gardens which were established reflected the simple tastes and sparsity of the interwar period.

Interwar period gardens are encouraged, as are front gardens that do not include built features such as walls and structures.

Guidelines

16.1 Gardens and Structures

A planning permit is not required for gardening. Very few gardens suffer from neglect or poor quality within the Estate. Residents are encouraged to maintain established gardens and trees to complement their homes. The existing well-maintained gardens provide a reasonable standard.

Garden structures such as pergolas do require a planning permit and can be integrated into garden designs, but they should be unobtrusive and should not screen the dwelling. In no case should they be located in front of the dwelling, integrate with the front fence or entry, or be attached to the dwelling.

16.2 Paths

Pathways should be maintained as simple uncoloured concrete tracks for cars.

Paths may also use Castlemaine slate finishes, Crazy paving or paving squares in concrete or Castlemaine slate.

Coloured concrete or bluestone sets should not be used where visible in the public domain.



Figure 24: Driveway and pedestrian pathways as plain uncoloured concrete tracks, causing minimal use of hard pavings.

17.0 Demolition

The Estate is highly intact with no loss of original buildings – while some parts of buildings may have been removed, the dwellings have been substantially retained. The Estate therefore has a high level of integrity and demolition of whole buildings or visible elements of dwellings will severely diminish the significance of the area as a whole.

The Port Phillip Heritage Policy in the Planning Scheme applies to all Heritage Overlay areas in Port Phillip, including the Dunstan Estate (Heritage Overlay area HO2). The Port Phillip Heritage Policy contains heritage objectives and polices in relation to demolition, and applications for demolition of buildings within the Estate must address the relevant provisions of this policy.

Guidelines

- ❑ Demolition of an entire dwelling will generally not be permitted. The rear section of some dwellings may be able to be demolished without affecting the heritage significance of the building, subject to any new addition being sympathetic to the scale and form of the original building and respecting the character of the area.
- ❑ Any decision regarding demolition will be assessed against the provisions of the Port Phillip Planning Scheme, particularly Clause 22.04 Heritage Policy.



18.0 Subdivision, Consolidation and Multi-Unit Development

The repeating rhythm of pairs of attached dwellings is critical to the character of the Estate and additional dwellings which disrupt this rhythm are discouraged.

Additional dwellings will only be considered where the original dwelling is retained and where the new dwelling is at the rear of the site and effectively out of view from the street. Given the angled exposure of most of the properties within the Estate, almost all of the sites are not suitable for multi-unit developments.

Guidelines

18.1 Subdivision and Multi-Unit Development:

- ❑ Subdivision and multi-unit development is not encouraged within the boundaries of the Estate. Dual occupancy may be permitted if the criteria of these guidelines are wholly satisfied.
- ❑ “Granny flats”, or dependant persons units, may be permitted provided they do not involve subdivision and conform to the guidelines for alterations and additions.

18.2 Consolidation

Consolidation of individual sites into larger lots in order to achieve practicable multi-unit development at the rear of existing dwellings may be appealing, however this will threaten the significant rhythm of the subdivision pattern and site layouts.

- ❑ Consolidation of individual sites into larger areas for multi-unit development or any other purpose is not encouraged.
- ❑ Joining of two dwellings into one may be permitted provided that the criteria of these guidelines are observed.

YOUR NEIGHBOURHOOD YOUR FUTURE!

Port Phillip Design Manual

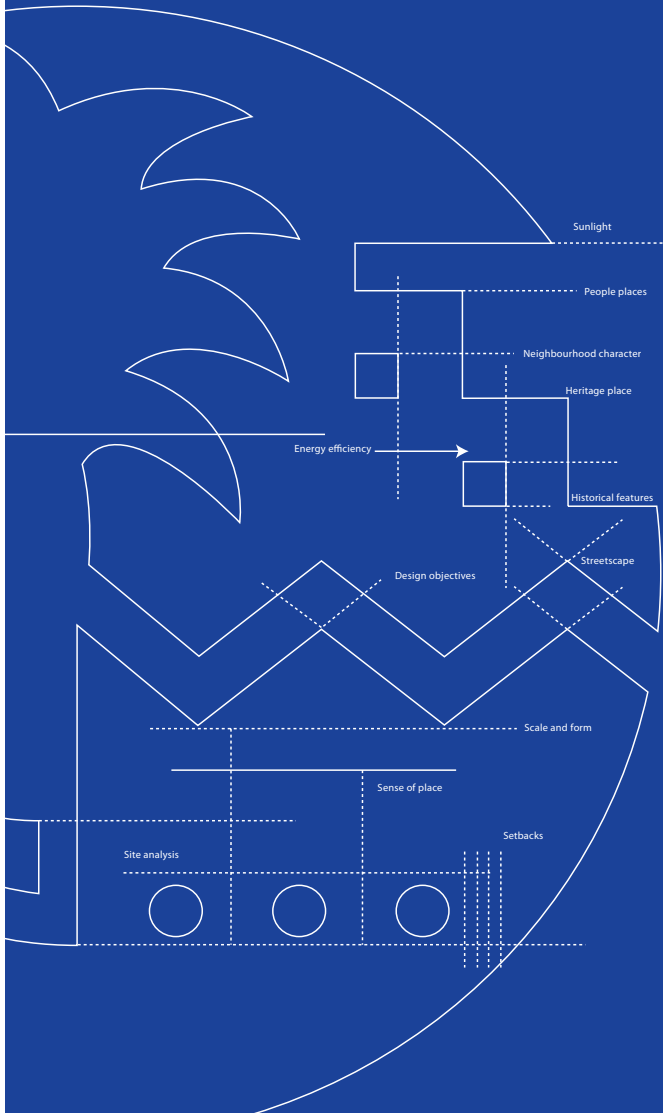

Appendix 1

Neighbourhood Character Statements - Established Residential Precincts

Residential Precinct R1

Character Type: Main Road Diverse Character



Key Existing Characteristics

- A range of dwelling styles from different eras are present. There are some limited examples of Victorian dwellings that are generally in an average condition, as well as Edwardian, Interwar, 1960s-70s flats and contemporary dwellings and blocks of flats.
- Smaller single storey dwellings are often dominated by the 2-3 storey blocks of flats present in this precinct.
- These two sections of Inkerman Street and Chapel Street contain varied lot sizes, ranging from medium to large. Front and side setbacks are varied.
- Gardens are generally low maintenance. Where they exist, lawns, garden beds, small trees and shrubs help to soften the built form.
- Both roads are fairly heavily trafficked and some properties have high front fences.

Preferred Character Statement

Replacement of buildings in poor condition will occur in the form of new contemporary development that is of a high standard of design. New single dwellings and medium density housing will sit alongside restored and renovated original dwellings. While the building scale of the precinct will be varied, new development will provide a transitional scale to adjoining buildings. Front boundaries will continue to be either open or lined with fences that allow views through or over the fence into the front garden. Garden areas will be landscaped with vegetation suited to small or limited landscaping areas.

Residential Precinct R1

Design Guidelines

Character Element	Objective	Design Response	Avoid
Existing Buildings	To encourage the replacement, or adaptive reuse/renovation of buildings in poor condition with medium-density, contemporary infill development.	<ul style="list-style-type: none"> > New development should be distinguishable from original dwelling stock through high quality contemporary architecture. 	<i>Reproduction styles and detailing.</i>
Landscaping and Vegetation	To strengthen the garden settings of dwellings and to create outdoor spaces and landscaping areas wherever possible in new development.	<ul style="list-style-type: none"> > Retain established trees and provide for the planting of new trees and vegetation. > In new multi-dwelling developments, consider the use of more innovative landscaping options such as planter boxes, climbers, creepers and the establishment of roof-top gardens. 	<i>Lack of landscaping and vegetation.</i>
Siting	To minimise the loss of front garden space and the dominance of car parking structures and vehicle crossovers.	<ul style="list-style-type: none"> > Locate garages and carports behind the line of the dwelling. > Minimise paving in front garden areas including driveways and crossovers. > In new multi-dwelling developments consider the use of underground car parking or car parking that can be accessed from the rear of the site. > Where possible, provide vehicular access from a rear laneway. 	<p><i>Car parking structures that dominate the façade or view of the dwelling.</i></p> <p><i>Creation of new crossovers and driveways or wide crossovers.</i></p> <p><i>Front setbacks dominated by impervious surfaces.</i></p>
Height and Building Form	To ensure that new development is respectful of existing period buildings.	<ul style="list-style-type: none"> > New multi-storey developments adjoining a lower-scale period dwelling should respect the height of the existing dwelling through the use of design techniques such as transitional scaling (recessing upper levels). 	<i>Buildings that dominate period buildings by height, siting or massing.</i>
Materials and Design Detail	To encourage innovative architecture and cultural expression through design.	<ul style="list-style-type: none"> > New buildings should be individually designed to respond to the characteristics of the site and adjoining buildings. > Cultural expression through colour, building details and architectural reinterpretation should be employed, including the use of contemporary building materials and the modern interpretation of period features. . > Articulate building façades through the well considered composition of openings and variations in wall surfaces. 	<p><i>Large, bulky buildings with unarticulated wall surfaces.</i></p> <p><i>Reproduction heritage styles.</i></p>
Front Boundary Treatment	To increase the openness of streetscapes.	<ul style="list-style-type: none"> > Provide a low or transparent front fence that allows views to the front garden and dwelling. > Applications for new development along heavily trafficked roads should investigate other measures for mitigating noise and privacy impacts, such as vegetation screening and double glazing. 	<i>High, solid front fences.</i>

Residential Precinct R2

Character Type: Victorian / Edwardian / Interwar / Post-war with Modern Overbuilding



Key Existing Characteristics

- Pakington Street is quite wide and is lined with consistent native street trees and 90° or angle parking in some parts. These attributes form a strong feature of the precinct and tend to dominate the character of the built form.
- The precinct contains a range of building styles including Victorian, Edwardian, Interwar and Post-war dwellings with 1960s-70s flats, some of which have been more recently updated.
- Single dwellings are between one and two storeys in height, while blocks of flats range in height up to four storeys.
- Lot size is varied, while front and side setbacks are generally consistent and small.
- Gardens are limited by small front setbacks but are generally established with small shrubs and occasional trees. The front setbacks of some blocks of flats are dominated by car parking areas.
- Consistent Paperbark street trees are present along Pakington Street.
- Fences are of mixed heights and styles. In some cases fences are absent altogether.

Preferred Character Statement

This precinct will accommodate further contemporary redevelopment through the replacement or updating of existing blocks of flats and replacement of existing dwellings in poor condition. New development that is located next to a period building will respect the scale of the existing dwelling. Medium density housing will be surrounded by landscaping that combines with street trees to add to a leafier character. New buildings will be articulated with architectural features such as balconies and variations in wall surfaces. Where possible, on-site car parking will be sited beneath or to the rear of buildings to reduce its dominance and allow for visible landscaping space.

Residential Precinct R2

Design Guidelines

Character Element	Objective	Design Response	Avoid
Existing Buildings	To encourage retention of Victorian, Edwardian and Interwar dwellings in good condition, and replacement of buildings in poor condition with contemporary infill development.	<ul style="list-style-type: none"> > Retain Victorian, Edwardian and Interwar dwellings that contribute to the valued character of the area. > Alterations and extensions to Victorian, Edwardian and Interwar buildings should be appropriate to the building era and style. > New development should be distinguishable from original dwelling stock through high quality contemporary architecture. 	<p><i>Demolition of visible parts of intact Victorian, Edwardian and Interwar dwellings.</i></p> <p><i>Reproduction styles and detailing.</i></p>
Landscaping and Vegetation	To strengthen the garden settings of dwellings and to create outdoor spaces and landscaping areas wherever possible in new development.	<ul style="list-style-type: none"> > Retain established trees and provide for the planting of new canopy trees and vegetation. > 	<i>Lack of landscaping and vegetation.</i>
Siting	To provide space for front gardens.	<ul style="list-style-type: none"> > Buildings should be set back from the front boundary to accommodate a front garden. 	<i>Loss of front garden space.</i>
	To minimise the loss of front garden space and the dominance of car parking structures and vehicle crossovers.	<ul style="list-style-type: none"> > Locate garages and carports behind the line of the dwelling. > Minimise paving in front garden areas including driveways and crossovers. > In new multi-dwelling developments consider the use of underground car parking or car parking that can be accessed from the rear of the site. > Where possible, provide vehicular access from a rear laneway. 	<p><i>Car parking structures that dominate the façade or view of the dwelling.</i></p> <p><i>Creation of new crossovers and driveways or wide crossovers.</i></p> <p><i>Front setbacks dominated by impervious surfaces.</i></p>
Height and Building Form	To ensure that the height and scale of new development is respectful of existing period buildings.	<ul style="list-style-type: none"> > New multi-storey developments adjoining a lower-scale period dwelling should respect the height of the existing dwelling through the use of design techniques such as transitional scaling (recessing upper levels). 	<i>Buildings that dominate period buildings by height, siting or massing.</i>
Materials and Design Detail	To encourage innovative architecture and cultural expression through design.	<ul style="list-style-type: none"> > New buildings should be individually designed to respond to the characteristics of the site and adjoining buildings. > Cultural expression through colour, building details and architectural reinterpretation should be employed, including the use of contemporary building materials and the modern interpretation of period features. > Articulate building façades through the well considered composition of openings and variations in wall surfaces. > A restrained mix of materials should be used, especially for small sites. 	<i>On small sites, the use of several differing materials and colours in building facades.</i>
Front Boundary Treatment	To maintain and increase the openness of streetscapes.	<ul style="list-style-type: none"> > Provide a low or transparent front fence that allows views to the front garden and dwelling. > Provide a front fence that is compatible with the era of development. 	<i>High, solid front fences.</i>

Residential Precinct R3

Character Type: Victorian / Interwar / Post-war Garden Suburban



Key Existing Characteristics

- This precinct has a strong base of double fronted Victorian cottages, however significant overbuilding has occurred throughout the Interwar and Post-war eras. There are some limited examples of Edwardian terraces and contemporary buildings.
- Streetscapes generally have a small-scale, single storey atmosphere, however occasional larger buildings between two and three storeys interrupt this pattern.
- Dwellings are often grouped by era with consistent buildings in a row – e.g. Victorian cottages, blocks of flats and occasionally, Edwardian terraces.
- Lot sizes are generally small but some larger blocks occur throughout. Front and side setbacks are also generally small.
- Gardens are limited by small front setbacks, but are generally established with small shrubs and occasional trees.
- Consistent Paperbark street trees are present along Camden and Linton Streets.
- In Linton Street, Paperbark street trees are particularly large and bushy, forming a significant visual element in the streetscape that tends to dominate the built form.
- Front fences are low to medium height and of mixed styles.
- On-street car parking is a dominant feature of the area, with few properties having on-site car parking due to small front setbacks.

Preferred Character Statement

Existing Victorian and Interwar dwellings will be maintained and restored. Post-war development will be updated or replaced with buildings that respect the predominant scale of existing buildings. The consistent character elements of this precinct, such as front and side setbacks and height and building form will be reflected in new development. Gardens spaces will be enhanced with vegetation suited to small areas that combines with street trees to create a leafy character. Front gardens will be lined with low to medium height front fences that are suited to the era of development.

Residential Precinct R3

Design Guidelines

Character Element	Objective	Design Response	Avoid
Existing Buildings	To encourage retention of Victorian and Interwar dwellings in good condition.	<ul style="list-style-type: none"> > Retain Victorian and Interwar dwellings that contribute to the character of the area. > Alterations and extensions to Victorian and Interwar buildings should be appropriate to the building era and style. > New development should be distinguishable from original dwelling stock through the use of contemporary architecture. 	<p><i>Demolition of visible parts of intact Victorian and Interwar dwellings.</i></p> <p><i>Reproduction styles and detailing.</i></p>
Landscaping and Vegetation	To strengthen the landscape qualities of small garden settings and to create outdoor spaces and landscaping areas wherever possible in new development.	<ul style="list-style-type: none"> > Retain established trees and provide for the planting of new trees and vegetation. > In new multi-dwelling developments, consider the use of more innovative vertical landscaping options such as planter boxes, climbers, creepers and the establishment of roof-top gardens. 	<i>Lack of landscaping and vegetation.</i>
Siting	To provide space for front gardens.	<ul style="list-style-type: none"> > Buildings should be set back from the front boundary to accommodate a small front garden. 	<i>Loss of front garden space.</i>
	To minimise the loss of front garden space and the dominance of car parking structures and vehicular crossovers.	<ul style="list-style-type: none"> > Locate garages and carports behind the line of the dwelling. > Minimise paving in front garden areas including driveways and crossovers. > In new multi-dwelling developments consider the use of underground car parking or car parking that can be accessed from the rear of the site. > Where possible, provide vehicular access from a rear laneway. 	<p><i>Car parking structures that dominate the façade or view of the dwelling.</i></p> <p><i>Creation of new crossovers and driveways or wide crossovers.</i></p> <p><i>Front setbacks dominated by impervious surfaces.</i></p>
Height and Building Form	To ensure that the height and scale of new development is respectful of existing period buildings and the streetscape.	<ul style="list-style-type: none"> > Where a new development abuts existing single storey period dwellings on both sides, set back upper levels so that the higher elements are recessive in the streetscape. > Where a new multi-storey development abuts existing buildings of differing heights (e.g. single storey on one side and two or three storey on the other), a graduated transitional scale should be employed in the design of the new development. 	<i>Buildings that dominate period buildings by height, siting or massing.</i>
Materials and Design Detail	To encourage innovative architecture and cultural expression through design.	<ul style="list-style-type: none"> > New buildings should be individually designed to respond to the characteristics of the site and adjoining buildings. > Cultural expression through colour, building details and architectural reinterpretation should be employed, including the use of face brick, stucco render and weatherboard. > Articulate building façades through the well considered composition of openings and variations in wall surfaces. 	<i>Large, bulky buildings with unarticulated wall surfaces.</i>
Front Boundary Treatment	To maintain and increase the openness of streetscapes.	<ul style="list-style-type: none"> > Provide a low front fence that allows views to the front garden and dwelling. > Provide a front fence that is compatible with the era of development. 	<i>High, solid front fences.</i>

Residential Precinct R4

Character Type: Victorian / Edwardian / Interwar / Post-war with Modern Overbuilding



Key Existing Characteristics

- The precinct has a strong interface at the core area of the Carlisle Street Activity Centre, facing onto car parks and the rear of businesses located on Carlisle Street.
- Building style is mixed however the precinct has a strong base of Edwardian dwellings. There are also a very small number of Victorian dwellings towards the west of the precinct.
- Overbuilding has occurred largely in the form of 1960s-70s flats and single dwellings. There are also some examples of Interwar dwellings and, particularly towards the east of the precinct, newer contemporary medium-density dwellings.
- Dwellings are predominantly single storey, while the small number of blocks of flats are two storeys in height.
- Lot sizes are varied. Front and side setbacks are generally small.
- Gardens are limited by small front setbacks and street trees are irregular. Native street trees lining the edge of the car parks south of the precinct help to soften the interface between the residential and commercial area.
- Front fences are of mixed heights and styles.

Preferred Character Statement

This precinct will continue to be comprised of a mix of building styles. Building replacement may occur along Alfred Street in the form of medium density housing, and will provide a transitional scale to the existing dwellings to the north. Any new development along Alfred Street will respond to the design detail of existing Edwardian dwellings, and will provide the perception of a ground floor dwelling every six to eight metres. The interface between the residential and commercial area will appear seamless, with transitional building scales and retention of existing landscaping space. Existing Edwardian and Interwar dwellings in good condition along Camden and Nelson Streets will be retained and enhanced through restoration. Any redevelopment along these streets will reflect the existing scale and built form.

Residential Precinct R4

Design Guidelines

Character Element	Objective	Design Response	Avoid
Existing Buildings	<p>Along Camden and Nelson Streets, to encourage retention of Edwardian and Interwar dwellings in good condition.</p> <p>Along Alfred Street, to encourage the replacement of dwellings in poor condition with medium-density, contemporary infill development.</p>	<ul style="list-style-type: none"> > Retain Edwardian and Interwar dwellings that contribute to the valued character of Camden and Nelson Streets. > Alterations and extensions to Edwardian and Interwar buildings should be appropriate to the building era and style. > New development should be distinguishable from original dwelling stock through the use of contemporary architecture. 	<p><i>Demolition of visible parts of intact Edwardian and Interwar dwellings.</i></p> <p><i>Reproduction styles and detailing.</i></p>
Landscaping and Vegetation	To strengthen the garden settings of dwellings and to create outdoor spaces and landscaping areas wherever possible in new development.	<ul style="list-style-type: none"> > Retain established trees and provide for the planting of new trees and vegetation. > In new multi-dwelling developments, consider the use of more innovative landscaping options such as planter boxes, climbers, creepers and the establishment of roof-top gardens. 	<i>Lack of landscaping and vegetation.</i>
Siting	To minimise the dominance of car parking structures and vehicular crossovers.	<ul style="list-style-type: none"> > Minimise paving in front garden areas including driveways and crossovers. > In new multi-dwelling developments consider the use of underground car parking or car parking that can be accessed from the rear of the site. > Where possible, provide vehicular access from a rear laneway. 	<p><i>Car parking structures that dominate the façade or view of the dwelling.</i></p> <p><i>Creation of new crossovers and driveways or wide crossovers.</i></p> <p><i>Front setbacks dominated by impervious surfaces.</i></p>
	To provide space for front gardens	> Buildings should be set back from the front boundary to accommodate a small front garden.	<i>Loss of front garden space.</i>
Height and Building Form	Along Alfred Street, to provide a graduated transition from the established single storey development to the north, and the more intense building forms anticipated in the commercial area to the south.	> New development along Alfred Street should incorporate a higher built form at the street boundary, scaling down to abutting single storey dwellings to the rear.	<p><i>Buildings that dominate the single storey scale of dwellings to the rear of Alfred Street properties.</i></p> <p><i>Underdevelopment of sites at the interface with the commercial precinct (Carlisle Street Activity Centre).</i></p>
Materials and Design Detail	<p>Along Alfred Street, to reflect the design detail of existing Edwardian dwellings.</p> <p>To encourage innovative architecture and cultural expression through design.</p>	<ul style="list-style-type: none"> > New buildings should be individually designed to respond to the characteristics of the site and adjoining buildings. > Cultural expression through colour, building details and architectural reinterpretation should be employed. > Articulate building façades through the well 	<p><i>Large bulky buildings with unarticulated facades.</i></p> <p><i>Poor composition of openings and setbacks.</i></p>

considered composition of openings and variations in wall surfaces.

**Front
Boundary
Treatment**

To maintain the strong relationship between buildings and the street environment.

- > Provide a low front fence that allows views to the dwelling and any open space at the front of the dwelling.
- > Provide a front fence that is compatible with the era of development.

High, solid front fences.

Residential Precinct R5

Character Type: Victorian / Interwar / Post-war Garden Suburban



Key Existing Characteristics

- Originally this precinct would have been dominated by larger Victorian homes, however significant overbuilding occurred throughout the Interwar and Post-war eras, particularly in the form of blocks of flats, duplexes and larger single brick dwellings
- Inkerman Street is dominated by blocks of flats from the post-war era, generally between two and three storeys.
- There are some examples of terraces from different eras, in groups of 2-5 dwellings.
- Recent years have seen the renovation and external rendering of 1960s-70s flats as well as the development of some contemporary buildings.
- Freestanding dwellings are generally one or two storeys in height and blocks of flats are generally between two and three storeys in height. The small number of terraces in the precinct are, in contrast, smaller scale and single storey.
- Buildings are generally grouped with other buildings of similar height and built form.
- Larger block sizes are present throughout Blenheim and Westbury Streets.
- Front and side setbacks are varied. Gardens are established, but small in Westbury Street. Streets are lined with bluestone kerbing and asphalt footpaths.
- In Blenheim Street, regular Paperbark trees are planted on the footpath whereas Westbury Street contains irregular plantings of mixed species.
- Front boundary treatment is mixed, however most front fences are low to medium height.

Preferred Character Statement

The mixed character of this precinct will continue to attract different styles of development that sit alongside dwellings from various eras. The large lot sizes will attract medium density housing developments of a high architectural standard. New development will interpret features of any adjoining period buildings in a contemporary manner, and will reflect the existing pattern of setbacks. Existing post-war flats will be redeveloped or renovated in order to revitalise streetscapes. Limited garden spaces will be innovatively landscaped to soften the existing hard-edged built form.

Residential Precinct R5

Design Guidelines

Character Element	Objective	Design Response	Avoid
Existing Buildings	To encourage retention of Victorian and Interwar dwellings in good condition.	<ul style="list-style-type: none"> > Retain Victorian dwellings that contribute to the character of the area. > Alterations and extensions to Victorian and Interwar buildings should be appropriate to the building era and style. > New development should be distinguishable from original dwelling stock through the use of contemporary architecture. 	<p><i>Demolition of visible parts of intact Victorian and Interwar dwellings.</i></p> <p><i>Reproduction styles and detailing.</i></p>
Landscaping and Vegetation	To strengthen the garden settings of dwellings and to create outdoor spaces and landscaping areas wherever possible in new development.	<ul style="list-style-type: none"> > Retain established trees and provide for the planting of new trees and vegetation. > In new multi-dwelling developments, consider the use of more innovative landscaping options such as planter boxes, climbers, creepers and the establishment of roof-top gardens. 	<i>Lack of landscaping and vegetation.</i>
Siting	To provide space for front gardens.	<ul style="list-style-type: none"> > Buildings should be set back from the front boundary to accommodate a front garden. 	<i>Loss of front garden space.</i>
	To minimise the loss of front garden space and the dominance of car parking structures and vehicular crossovers.	<ul style="list-style-type: none"> > Locate garages and carports behind the line of the dwelling. > Minimise paving in front garden areas including driveways and crossovers. > Where required, provide only one vehicular crossover per frontage. > In new multi-dwelling developments consider the use of underground car parking or car parking that can be accessed from the rear of the site. 	<p><i>Car parking structures that dominate the façade or view of the dwelling.</i></p> <p><i>Creation of new crossovers and driveways or wide crossovers.</i></p> <p><i>Front setbacks dominated by impervious surfaces.</i></p>
Height and Building Form	To ensure that the height and scale of new development is respectful of existing period buildings and the streetscape.	<ul style="list-style-type: none"> > Where a new development abuts existing single storey period dwellings on both sides, set back upper levels so that the higher elements are recessive in the streetscape. > Where a new multi-storey development abuts existing buildings of differing heights (e.g. single storey on one side and two or three storey on the other), a graduated transitional scale should be employed in the design of the new development. 	<i>Buildings that dominate period buildings by height, siting or massing.</i>
Materials and Design Detail	To encourage innovative architecture and cultural expression through design.	<ul style="list-style-type: none"> > New buildings should be individually designed to respond to the characteristics of the site and adjoining buildings. > Cultural expression through colour, building details and architectural reinterpretation should be employed. > Use of feature materials reflective of Interwar development, including brickwork and polychromatic bricks. > Articulate building façades through the well considered composition of openings and 	<i>Large, bulky buildings with unarticulated wall surfaces.</i>

variations in wall surfaces.

**Front
Boundary
Treatment**

To maintain and increase
the openness of
streetscapes.

- > Provide a front fence that allows views to the front garden and dwelling.
- > Provide a front fence that is compatible with the era of development.

*High, solid front
fences.*

Residential Precinct R6

Character Type: Victorian / Edwardian / Interwar Garden Suburban



Key Existing Characteristics

- Building style is dominated by Victorian and Edwardian single dwellings. Some Interwar dwellings are also present. Very little infill has occurred throughout the precinct and is generally in the form of 1960s-70s and contemporary flats at the edge of the precinct.
- Buildings are predominantly single storey however blocks of flats at the edge of the precinct are between two and three storeys in height.
- Lot sizes are small to medium (generally less than 500sqm), however there are some larger lots that are occupied by flats.
- Front setbacks are generally small to medium while side setbacks are varied. Buildings are generally set back from one or both side boundaries.
- Gardens are low to medium scale with occasional canopy trees that combine with irregular plantings of street trees in Balston Street to create a leafy character.
- Along Inkerman Street, the lack of street trees and nature strips means that the built form is the dominant characteristic of the street.
- Front boundary treatment is mixed.

Preferred Character Statement

Victorian, Edwardian and Interwar dwellings will be maintained and enhanced through careful restoration, and where applicable, appropriate adaptation. Some buildings in poor condition will provide an opportunity for new development that respects the existing scale of the precinct and provides a contemporary interpretation of existing period dwellings. New development will also continue to reflect the existing pattern of front setbacks. Gardens will become a more established feature of streetscapes, with increased plantings of medium sized canopy trees and shrubs. Front fences will be low or transparent to allow views through or over the fence into the front garden.

Residential Precinct R6

Design Guidelines

Character Element	Objective	Design Response	Avoid
Existing Buildings	To encourage retention of intact dwellings that contribute to the valued character of the precinct.	<ul style="list-style-type: none"> > Retain Victorian, Edwardian and Interwar dwellings that contribute to the character of the area. > Alterations and extensions to buildings should be appropriate to the building era and style. > New development should be distinguishable from original dwelling stock through the use of contemporary architecture. 	<p><i>Demolition of visible parts of intact Victorian, Edwardian and Interwar dwellings.</i></p> <p><i>Reproduction styles and detailing.</i></p>
Landscaping and Vegetation	To maintain and increase the garden settings of streetscapes.	<ul style="list-style-type: none"> > Buildings should be sited and designed to retain large, established trees where present and to incorporate space for the planting of substantial vegetation, including canopy trees, on larger sites. 	<p><i>Lack of landscaping and substantial vegetation.</i></p> <p><i>Removal of large, established, healthy trees.</i></p>
Siting	To provide space for front gardens.	<ul style="list-style-type: none"> > Buildings should be set back from the front boundary to accommodate a front garden. 	<p><i>Loss of front garden space.</i></p>
	To maintain and reinforce the existing rhythm of spacing between dwellings.	<ul style="list-style-type: none"> > In Balston Street, where dwellings are predominantly detached, new development should reflect the existing pattern of side setbacks. > Where a new development is proposed to be sited on one side boundary, the section of the building on the boundary should be set back further than the facade of the adjoining building to create the appearance of space between buildings. 	<p><i>Boundary to boundary development where a detached style predominates.</i></p>
	To minimise the loss of front garden space and the dominance of car parking structures and vehicular crossovers.	<ul style="list-style-type: none"> > Locate garages and carports behind the line of the dwelling. > Minimise paving in front garden areas including driveways and crossovers. > In Balston Street, provide vehicular access from a rear laneway. 	<p><i>Car parking structures that dominate the façade or view of the dwelling.</i></p> <p><i>Creation of new crossovers and driveways or wide crossovers.</i></p> <p><i>Front setbacks dominated by impervious surfaces.</i></p>
Height and Building Form	To ensure that new development is respectful of the dominant height and building form in the streetscape.	<ul style="list-style-type: none"> > The height of the front of new development should match adjoining wall heights. Where adjoining wall heights differ (e.g. single storey on one side and two or three storey on the other), a graduated transitional scale should be employed. 	<p><i>Buildings that exceed by more than one storey the predominant building height in the street and nearby properties.</i></p>
	To ensure that the height of new development does not overwhelm adjoining single storey period buildings.	<ul style="list-style-type: none"> > Upper levels that exceed the predominant building height in the street should be accommodated in the roof space or recessed from the front façade. > Where a new development abuts single storey dwellings on both sides, setback upper levels so that the higher elements are recessive in the streetscape. > In Balston Street, provide a roof consistent with the predominant roof form in the street. 	<p><i>New development that dominates existing single storey dwellings.</i></p>

Materials and Design Detail	To encourage buildings that contribute positively to the streetscape by presenting visually interesting facades to the street.	<ul style="list-style-type: none"> > Articulate the form and facades of buildings through the use of different colours and materials, through the composition of openings and setbacks and through variations in wall surfaces. > Use materials and finishes that complement those evident in the streetscape, including a modern interpretation of period detailing. 	<i>Large, bulky buildings with unarticulated facades.</i>
------------------------------------	--	---	---

Front Boundary Treatment	To maintain the openness of streetscapes.	<ul style="list-style-type: none"> > Provide a front fence that is compatible with the era of development and allows views to the front garden and dwelling. 	<i>High, solid front fences.</i>
---------------------------------	---	--	----------------------------------

Residential Precinct R7

Character Type: Victorian / Interwar / Post-war Garden Suburban



Key Existing Characteristics

- Hotham Street is a busy main road. Many buildings are sheltered from the main road through the use of vegetation or high front fences.
- Whilst the character of the area is mixed, dwellings that are present from earlier eras are particularly intact. Some individual buildings may be of potential heritage value.
- There is a strong base of dwellings from the Victorian era mixed with some examples of Interwar and immediate post war dwellings from the late 1940s and early 1950s. The larger lot sizes have also attracted 1960s-70s blocks of flats to the precinct.
- Building height ranges between one and three storeys.
- Lot sizes range from medium to very large. Building setbacks are varied.
- Paperbark street trees help to soften the built form, while gardens are generally low-maintenance.
- The wide road and relatively low buildings mean that the precinct has a strong horizontal emphasis.

Preferred Character Statement

Existing Victorian dwellings in good condition will be retained. Larger lot sizes will attract further redevelopment including medium density housing. New development will be well articulated with variations in wall surfaces and through the composition of openings and setbacks. Where a new development adjoins an existing Victorian dwelling, it will provide an innovative design response that respects the scale, form and setbacks of the existing building. The built form and dominance of hard surfaces will be lessened through landscaping suited to the size of garden spaces. Where possible, higher front fences will be avoided in favour of other measures, such as vegetation screening, to enhance privacy and reduce noise impacts.

Residential Precinct R7

Design Guidelines

Character Element	Objective	Design Response	Avoid
Existing Buildings	To encourage retention of Victorian and Interwar dwellings in good condition.	<ul style="list-style-type: none"> > Retain Victorian and Interwar dwellings that contribute to the character of the area. > Alterations and extensions to Victorian and Interwar buildings should be appropriate to the building era and style. > New development should be distinguishable from original dwelling stock through the use of contemporary architecture. 	<p><i>Demolition of visible parts of intact Victorian and Interwar dwellings.</i></p> <p><i>Reproduction styles and detailing.</i></p>
Landscaping and Vegetation	To strengthen the garden settings of dwellings and to create outdoor spaces and landscaping areas wherever possible in new development.	<ul style="list-style-type: none"> > Retain established trees and provide for the planting of new canopy trees and vegetation. > In new multi-dwelling developments, consider the use of more innovative landscaping options such as planter boxes, climbers, creepers and the establishment of roof-top gardens. 	<i>Lack of landscaping and vegetation.</i>
Siting	To minimise the loss of front garden space and the dominance of car parking structures and vehicular crossovers.	<ul style="list-style-type: none"> > Locate garages and carports behind the line of the dwelling. > Minimise paving in front garden areas including driveways and crossovers. > In new multi-dwelling developments consider the use of underground car parking or car parking that can be accessed from the rear of the site. > Where possible, provide vehicular access from a rear laneway. 	<p><i>Car parking structures that dominate the façade or view of the dwelling.</i></p> <p><i>Creation of new crossovers and driveways or wide crossovers.</i></p> <p><i>Front setbacks dominated by impervious surfaces.</i></p>
Height and Building Form	To ensure that the height and scale of new development is respectful of existing period buildings.	<ul style="list-style-type: none"> > New multi-storey developments adjoining a lower-scale period dwelling should respect the height of the existing dwelling through the use of design techniques such as transitional scaling (recessing upper levels). 	<i>Buildings that dominate period buildings by height, siting or massing.</i>
Materials and Design Detail	To encourage innovative architecture and cultural expression through design.	<ul style="list-style-type: none"> > New buildings should be individually designed to respond to the characteristics of the site and adjoining buildings. > Cultural expression through colour, building details and architectural reinterpretation should be employed. > Articulate building façades through the well considered composition of openings and variations in wall surfaces. 	<i>Large, bulky buildings with unarticulated wall surfaces.</i>
Front Boundary Treatment	To increase the openness of streetscapes.	<ul style="list-style-type: none"> > Provide a front fence that allows views to the front garden and dwelling. > Where high front fences are proposed, the fence should be set back, or should incorporate recesses for planting. > Applications for new development along heavily trafficked roads should investigate other measures for mitigating noise and privacy impacts, such as vegetation screening and double glazed windows. 	<i>High, solid front fences.</i>

Residential Precinct R8

Character Type: Victorian / Interwar / Post-war Garden Suburban



Key Existing Characteristics

- The precinct is predominated by Victorian dwellings and post-war 1960s-70s buildings. There are also some limited examples of Interwar and Edwardian dwellings and some overbuilding has occurred in the form of contemporary units and duplexes.
- 1960s-70s buildings tend to dominate other building styles within the precinct.
- Some Victorian era dwellings are particularly intact and may be of potential heritage value, while others are in relatively poor condition.
- Both the Avenue and Gourlay Street have relatively wide roadways, however characteristics such as on-street car-parking and a high proportion of blocks of flats results in streetscapes that appear to be in proportion.
- Building height ranges between one and three storeys.
- Buildings are generally set back from one or both side boundaries.
- Lot sizes range from medium to large. Front and side setbacks are generally small, however some original Victorian homes have larger setbacks.
- Front gardens are generally limited due to small front setbacks. Street trees are inconsistent.
- Front boundary treatment is mixed.
- Although technically not in the Carlisle Street Activity Centre, the southern side of Gourlay Street is comprised of almost all 1960s-70s flats which are particularly consistent in building scale, form and setbacks. This has a strong impact on the character of the streetscape.

Preferred Character Statement

Walk-up flats and contemporary development in the form of apartments and duplexes will become the most dominant building styles throughout this precinct. 1960s-70s walk-up flats will be updated to revitalise streetscapes, and Victorian dwellings will be maintained and carefully restored where necessary. Where located next to an existing Victorian dwelling in good condition, new development will provide an innovative design response that respects the scale, form and setbacks of the existing dwelling. Buildings will be articulated with features such as variations in wall surfaces and through the composition of openings and setbacks. Landscaping will play a greater role in new development, with carefully considered garden spaces and vegetation that reduces the impact of the built form on the streetscape.

Residential Precinct R8

Design Guidelines

Character Element	Objective	Design Response	Avoid
Existing Buildings	To encourage retention of Victorian and Interwar dwellings in good condition.	<ul style="list-style-type: none"> > Retain Victorian and Interwar dwellings that contribute to the character of the area. > Alterations and extensions to Victorian and Interwar buildings should be appropriate to the building era and style. > New development should be distinguishable from original dwelling stock through the use of contemporary architecture. 	<p><i>Demolition of visible parts of intact Victorian and Interwar dwellings.</i></p> <p><i>Reproduction styles and detailing.</i></p>
Landscaping and Vegetation	To strengthen the garden settings of dwellings and to create outdoor spaces and landscaping areas wherever possible in new development.	<ul style="list-style-type: none"> > Retain established trees and provide for the planting of new trees and vegetation. > In new multi-dwelling developments, consider the use of more innovative landscaping options such as planter boxes, climbers, creepers and the establishment of roof-top gardens. 	<i>Lack of landscaping and vegetation.</i>
Siting	To minimise the loss of front garden space and the dominance of car parking structures and vehicular crossovers.	<ul style="list-style-type: none"> > Locate garages and carports behind the line of the dwelling. > Minimise paving in front garden areas including driveways and crossovers. > In new multi-dwelling developments consider the use of underground car parking or car parking that can be accessed from the rear of the site. > Where possible, provide vehicular access from a rear laneway. 	<p><i>Car parking structures that dominate the façade or view of the dwelling.</i></p> <p><i>Creation of new crossovers and driveways or wide crossovers.</i></p> <p><i>Front setbacks dominated by impervious surfaces.</i></p>
	To maintain and reinforce the existing rhythm of spacing between buildings	<ul style="list-style-type: none"> > New development should reflect the existing pattern of side setbacks. 	<i>Boundary-to-boundary development, unless characteristic of a site or adjoining sites.</i>
Height and Building Form	To ensure that the height and scale of new development is respectful of existing period buildings.	<ul style="list-style-type: none"> > New multi-storey developments adjoining a lower-scale period dwelling should respect the height of the existing dwelling through the use of design techniques such as transitional scaling (recessing upper levels). 	<i>Buildings that dominate period buildings by height, siting or massing.</i>
Materials and Design Detail	To encourage innovative architecture and cultural expression through design.	<ul style="list-style-type: none"> > New buildings should be individually designed to respond to the characteristics of the site and adjoining buildings. > Cultural expression through colour, building details and architectural reinterpretation should be employed, including the use of contemporary materials and detailing. > Articulate building façades through the well considered composition of openings and variations in wall surfaces. 	<i>Large, bulky buildings with unarticulated wall surfaces.</i>
Front Boundary Treatment	To maintain and increase the openness of streetscapes.	<ul style="list-style-type: none"> > Provide a low or transparent front fence that allows views to the front garden and dwelling. > Provide a front fence that is compatible with the era of development. 	<i>High, solid front fences.</i>

Residential Precinct R9

Character Type: Victorian / Edwardian / Interwar / Post-war with Modern Overbuilding



Key Existing Characteristics

- This precinct is dominated by Edwardian dwellings. There are also some examples of Interwar and post-war era buildings, including Californian Bungalows in Hawsleigh Avenue and 1960s-70s flats throughout.
- Buildings are generally set back from both side boundaries.
- The southern end of Carlisle Avenue is dominated by updated flats from the post-war era.
- Building height is predominantly between one and two storeys.
- Lot sizes are small-medium sized in Hawsleigh Avenue and medium sized in Carlisle Avenue. Building setbacks are varied. Older dwellings tend to have more generous front and side setbacks.
- In Carlisle Avenue, large avenue street trees combine with nature strips and bluestone kerbing to create a special character that may be of potential neighbourhood character significance.
- Hawsleigh Avenue is lined with consistent native street trees which also enhance its character.
- Front gardens are small, but well established, and combine with street trees and nature strips to create a leafy character.
- Front boundary treatment is mixed, however, most front boundaries are lined with medium to high fences.

Preferred Character Statement

Edwardian dwellings will continue to provide a strong base for this precinct, and will be well maintained and where necessary, appropriately restored. Post-war flat development will be updated with contemporary materials and finishes that complement those of period homes. Buildings in poor condition will provide opportunities for new replacement development that is respectful of the scale and form of period dwellings. New development will provide adequate space for landscaping that contributes to the leafy atmosphere of the precinct. Car-parking and associated structures will be avoided in the front setback of all properties in order to maximise space for landscaping and enhance the spacious feel of the streetscape. Front fences will be low or absent altogether in order to retain views to buildings.

Residential Precinct R9

Design Guidelines

Character Element	Objective	Design Response	Avoid
Existing Buildings	To encourage retention of Edwardian and Interwar dwellings in good condition.	<ul style="list-style-type: none"> > Retain Edwardian and Interwar dwellings that contribute to the valued character of the area. > Alterations and extensions to Edwardian and Interwar buildings should be appropriate to the building era and style. > New development should be distinguishable from original dwelling stock through the use of contemporary architecture. 	<p><i>Demolition of visible parts of intact Edwardian and Interwar dwellings.</i></p> <p><i>Reproduction styles and detailing.</i></p>
Landscaping and Vegetation	To strengthen the garden settings of dwellings and to create outdoor spaces and landscaping areas wherever possible in new development.	<ul style="list-style-type: none"> > Retain established trees and provide for the planting of new trees and vegetation. > In new multi-dwelling developments, consider the use of more innovative landscaping options such as planter boxes, climbers, creepers and the establishment of roof-top gardens. 	<i>Lack of landscaping and vegetation.</i>
Siting	To provide space for front gardens and maintain established setbacks.	<ul style="list-style-type: none"> > Buildings should be set back from the front boundary to accommodate a front garden. > Buildings should be set back from both side boundaries, reflective of existing built form. 	<i>Loss of front garden space.</i>
	To minimise the loss of front garden space and the dominance of car parking structures and vehicular crossovers.	<ul style="list-style-type: none"> > Locate garages and carports behind the line of the dwelling. > Minimise paving in front garden areas including driveways and crossovers. > In new multi-dwelling developments consider the use of underground car parking or car parking that can be accessed from the rear of the site. > Where possible, provide vehicular access from a rear laneway. 	<p><i>Car parking structures that dominate the façade or view of the dwelling.</i></p> <p><i>Creation of new crossovers and driveways or wide crossovers.</i></p> <p><i>Front setbacks dominated by impervious surfaces.</i></p>
Height and Building Form	To ensure that the height and scale of new development is respectful of existing period buildings.	<ul style="list-style-type: none"> > The height of the front of new development should match adjoining wall heights. Where adjoining wall heights differ (e.g. single storey on one side and two or three storey on the other), a graduated transitional scale should be employed. > Upper levels that exceed the predominant building height in the street should be accommodated in the roof space or recessed from the front façade. > Where a new development abuts single dwellings on both sides, setback upper levels so that the higher elements are recessive in the streetscape. > In Hawsleigh Avenue, provide a roof consistent with the predominant roof form in the street. 	<i>New development that overwhelms the single storey scale of the street.</i>
Materials and Design Detail	To encourage buildings that contribute positively to the streetscape by presenting visually interesting facades	<ul style="list-style-type: none"> > Articulate the form and facades of buildings through the use of different colours and materials, through the composition of openings and setbacks and through variations in wall surfaces. 	<i>Large, bulky buildings with unarticulated facades.</i>

to the street.

- > Use materials and finishes that complement those evident in the streetscape, including a modern interpretation of period detailing.
- > A restrained mix of materials should be used, especially for small sites.

On small sites, the use of several differing materials and colours in building facades.

**Front
Boundary
Treatment**

To maintain and increase the openness of streetscapes.

- > Provide a low or transparent front fence that allows views to the front garden and dwelling.
- > Provide a front fence that is compatible with the era of development.

High, solid front fences.

Residential Precinct R10

Character Type: Victorian Edwardian Inner Urban

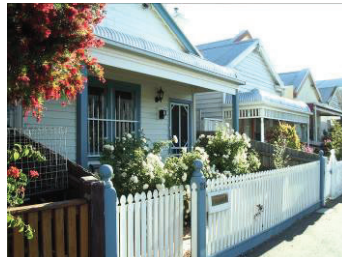

Key Existing Characteristics

- This precinct is a particularly consistent neighbourhood character area, which has been previously investigated for heritage significance (Heritage Alliance, 2004).
- The precinct is dominated by single-fronted Victorian dwellings. There are also limited examples of buildings from other eras, including those from the Edwardian, Interwar, post-war and contemporary periods.
- Materials are a mix of timber, brick and render. Most streets are dominated by lightly-coloured timber.
- Most streetscapes have a small-scale atmosphere due to narrow roadways, small-scale buildings and limited front setbacks and properties with narrow frontages to the street.
- Buildings are predominantly single storey, although there are some examples of double storey buildings.
- Bothwell Street is noticeably different from the other streets in this precinct. It cuts across the southern half of the precinct in a north-west to south-west direction and the properties that front onto it are of an irregular shape and size.
- The northern side of Bothwell Street is characterised by contemporary infill which is generally two storeys in height, while the southern side is characterised by a single-storey scale and rear fences of properties. A landscaped median strip runs down the centre of the street, creating a more spacious, leafy atmosphere.
- The fine-grain subdivision of this precinct has a strong influence on its overall character. Lot sizes are generally small, with only occasional larger lot sizes. Dwellings have minimal front and side setbacks, and there are some examples of terraced buildings throughout.
- Front gardens are typical of inner urban areas, with landscaping suited to limited planting areas due to small front setbacks. Gardens generally comprise small trees, shrubs and occasional garden beds.
- Streets are lined with bluestone kerbing and narrow asphalt footpaths, with only occasional street trees planted along the footpath. These characteristics add to the small-scale, built form dominated atmosphere of most streetscapes throughout the precinct.
- Rear laneways also influence the character of this precinct and are evidence of the fact that it is an older subdivision dating from the Victorian era.
- On-street car parking is a dominant feature of the area, with few properties having on-site car parking due to small front setbacks.
- Most properties are lined with low picket front fences.

- The car-parks and larger-scale buildings located on the northern side of Marlborough Street have an impact on the character of the northern edge of the precinct and result in a highly varied scale at this interface.

Preferred Character Statement

This precinct will retain the key character elements that contribute to its high level of consistency. Existing Victorian, Edwardian and Interwar dwellings will be well maintained and carefully restored where necessary. The small-scale inner urban atmosphere will be upheld in new development, with new buildings respecting the height, form and setbacks of existing buildings. New development will adopt simple design details that respect but do not replicate period detailing. Building materials and finishes will continue to contribute to the lightness of streetscapes created by lightly coloured timber. Front setbacks will be innovatively landscaped and front boundaries lined with low fences that suit the era of development and maintains the relationship between the street and buildings. New development on the northern side of Marlborough Street may be of a higher scale and more contemporary style, but should respond to the valued character elements of the southern side of the street through careful selection of building materials and modern interpretation of period design elements such as pitched roofs and verandas.

Residential Precinct R10

Design Guidelines

Character Element	Objective	Design Response	Avoid
Existing Buildings	To encourage retention of Victorian and Edwardian dwellings that contribute to the valued character of the area.	> In streets that contain intact groups of Victorian and Edwardian dwellings, consider retaining and/or adapting those buildings that are in good condition wherever possible in new development.	<i>Demolition of visible parts of intact Victorian and Edwardian dwellings.</i>
		> Alterations and extensions to Victorian and Edwardian dwellings should be appropriate to the building era and style.	<i>Reproduction of historic building styles.</i>
		> New development should be distinguishable from original dwelling stock through the use of contemporary architecture.	
Landscaping and Vegetation	To strengthen the small scale pattern of garden settings.	> New development should provide for the planting of vegetation suited to small garden areas.	<i>Lack of landscaping and vegetation.</i>
		>	<i>Large areas of impervious surfaces.</i>
Siting	To provide space for front gardens.	> Buildings should be set back from the front boundary to accommodate a front garden.	<i>Loss of front garden space.</i>
	To maintain and reinforce the existing rhythm of spacing between dwellings.	> In streets with predominantly terrace style housing, new dwellings should reflect the lack of side setbacks. > Where side setbacks are of a consistent size in the street, new development should reflect the existing pattern.	<i>Large side setbacks in streets where a terraced style predominates.</i>
Height and Building Form	To ensure that new development is respectful of the dominant height and building form in the streetscape.	> The height of the front of new development should match adjoining wall heights. Where adjoining wall heights differ (e.g. single storey on one side and two or three storey on the other), a graduated transitional scale should be employed.	<i>Buildings that exceed by more than one storey the predominant building height in the street and nearby properties.</i>
	To ensure that the height of new development does not overwhelm adjoining single storey period buildings	> Upper levels that exceed the predominant building height in the street should be accommodated in the roof space or recessed from the front façade. > Where a new development abuts single storey dwellings on both sides, set back upper levels so that the higher elements are recessive in the streetscape.	<i>New development that dominates existing single storey dwellings.</i>
		> Provide a pitched roof .	
Materials and Design Detail	To ensure that the use of materials and design detail in new development complements that of the predominant building styles in the street.	> New development should reflect the use of materials and reinterpret the design details of Edwardian and Victorian dwellings in a contemporary manner.	<i>Reproduction styles and detailing.</i>
		> A restrained mix of materials should be used, especially for small sites.	<i>Large buildings with poorly articulated wall surfaces.</i>
		> Articulate the form and façades of buildings through the use of different colours and materials, through the composition of openings and setbacks and through variations in wall surfaces.	<i>On small sites, the use of several differing materials and colours in building facades.</i>
		> New dwellings should incorporate timber (weatherboards) or other non-masonry materials and use subdued colours on external finishes.	
Front Boundary Treatment	To maintain the openness of streetscapes.	> Provide a low front fence that allows views to the front garden and dwelling.	<i>High, solid front fences.</i>
		> Provide a front fence that is compatible with the era of development and makes use of timber or other non-masonry materials.	

YOUR NEIGHBOURHOOD YOUR FUTURE!

Port Phillip Design Manual

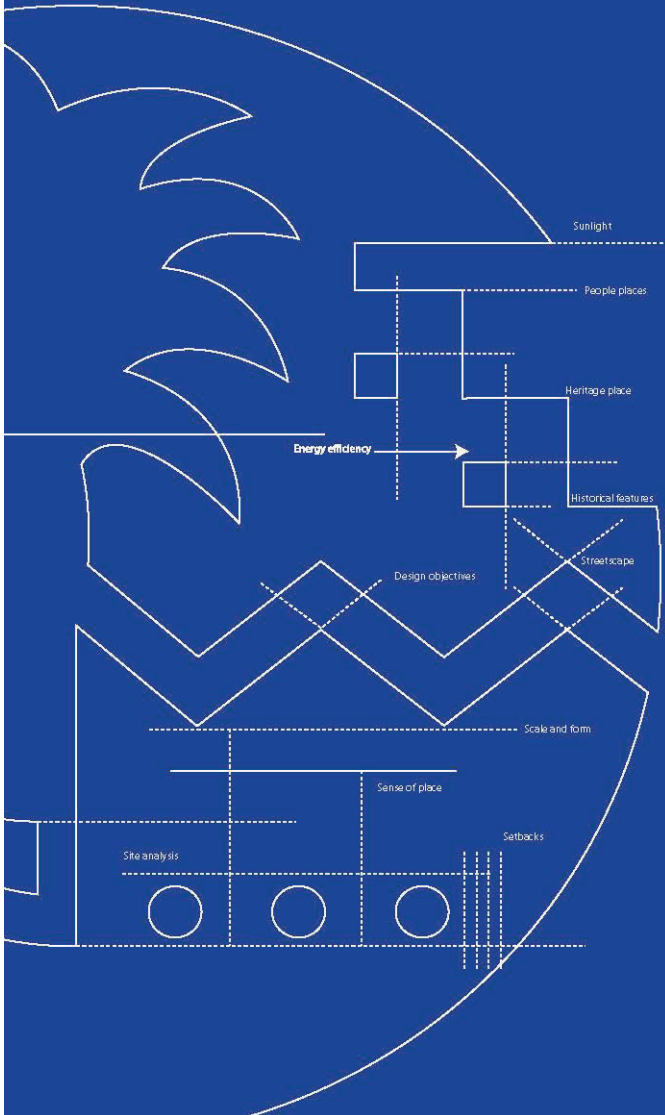

ESTABLISHED RESIDENTIAL PRECINCTS

Introduction

The residential areas to the south-east and north-west of the *Activity Centre* have a fine grain and low scale character, and are substantially affected by *Heritage Overlay 1 (HO1 – Port Melbourne)*. The structure plan aims to protect these areas, whilst providing for incremental housing growth in residential areas proximate to the activity centre that has existing diverse neighbourhood character.

There are four residential areas (*Residential Precincts 1 to 4*) that have capacity for incremental residential growth, based on a diverse neighbourhood character, which are identified on the *Established Residential Areas Housing Framework Plan*.

The following section comprises *Preferred Neighbourhood Character Statements* for these areas. Development must be in accordance with the 'Preferred Character Statement' and 'Design Response' contained in each statement.

Residential Precinct I: Garton Street

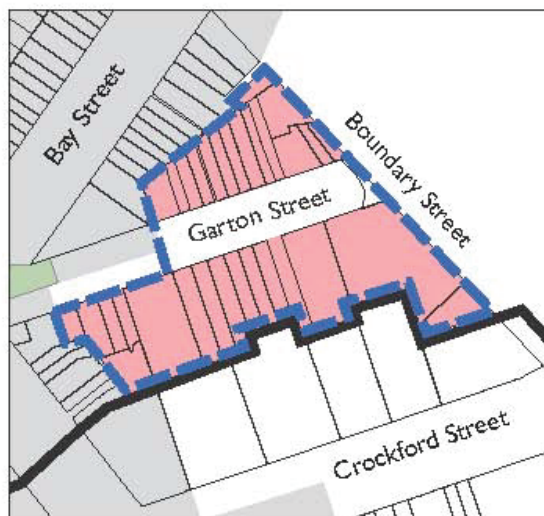
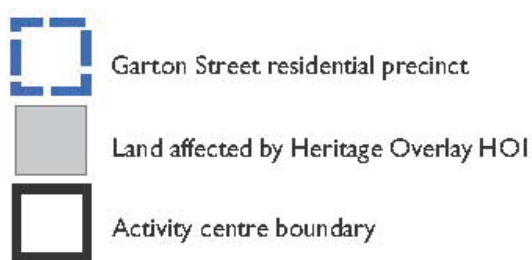

Above: north side of Garton Street.



Above: south side of Garton Street.

Existing character / Future category	Future Development Statement	Preferred Character Statement
Existing character type Victorian / Modern overbuilding	<ul style="list-style-type: none"> The two sides of Garton Street present differing residential development opportunities adjacent to the Crockford Street renewal precinct. Future development will make a transition in height down from Crockford Street (which is anticipated to be up to 5 storeys) towards the low scale established streetscapes in Bay Street (1 and 2 storeys). Lots on the southern side of the Garton Street are larger and have an interface with bulky buildings (fronting Crockford Street and also in Garton Street) and have redevelopment potential. New development on the southern side will be constructed up to 3 storeys. Townhouse type development will reflect the existing grain and setback in Garton Street. The remaining warehouse building is also a development opportunity. The small lot size and consistent low building scale on the northern side of Garton Street will limit future development to single lot development, including single dwellings and additions to existing dwellings. Development on the northern side will respond to the existing low scale and intimate residential environment made up of 'contributory' properties outside of the Heritage Overlay (as shown on the City of Port Phillip Neighbourhood Character Policy Map). 	<ul style="list-style-type: none"> Existing Victorian dwellings in good condition will be encouraged to be retained particularly on the northern side. New buildings will reflect the existing streetscape grain and provide small front setbacks. Contemporary design responds to consistent existing streetscape elements, including verandahs, fascia lines and fence heights. Development on the southern side will be transitional in scale of 3 storeys (with scope for a 4th level if recessed from view). Townhouse style buildings will be well articulated with punctuated openings and balconies to the street. Redevelopment of the existing warehouse building will reinstate a residential land use and generally match the height of the existing building on the same site. Development on the northern side will respond to the existing low building scale and front setbacks and be limited to two storeys. Development adjacent to heritage places will be transitional in height and setbacks. Garages, carports, car parking spaces and vehicle access within the front setback are strongly discouraged.
Future residential change category Incremental change		

Design Response	
<i>Frontage widths:</i>	Match existing widths (range of 4 - 6 metres.)
<i>Siting and setbacks:</i>	<u>North side:</u> Match existing front setbacks (3 metres minimum).
	<u>South side:</u> 2 metres.
<i>Building height:</i>	<u>South side:</u> 3 storeys (any 4th level must be recessed from view).
	<u>North side:</u> 2 storeys.
<i>Design detail:</i>	<p>Reflect key horizontal lines within the street.</p> <p>Discourage vehicle access within front setback.</p> <p>Surveillance of street from all levels.</p> <p>Low scale fencing (0.8 – 1.2 metres).</p>
<i>Landscaping / planting:</i>	Low scale planting within front setback.

Residential Precinct 2: Dow Street (north)

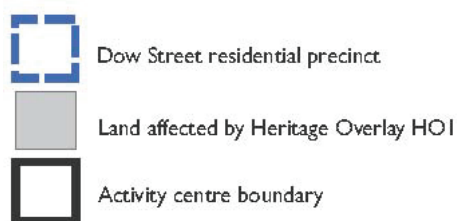

Above: Dwellings in Dow Street (west and east).

Above: Esplanade West.

Existing character / Future change category	Future Development Statement	Preferred Character Statement
Existing character type Victorian / Edwardian / Modern overbuilding	<ul style="list-style-type: none"> The varied character in the precinct provides scope for development which responds to existing identified character elements, and adjacent heritage places. New development will predominantly be in the form of new dwellings and extensions to existing dwellings. Multi-unit development will be limited and occur on the few larger remaining lots, or consolidated lots. Development will be 2 storeys in height, reference key streetscape elements, and continue predominant front setbacks. Surveillance of the street is incorporated at ground and first floor level. 	<ul style="list-style-type: none"> Further residential development to a high architectural standard responds to the existing pattern of development and nearby building styles. 'Contributory' properties outside of the Heritage Overlay (as shown on the City of Port Phillip Neighbourhood Character Policy Map) are encouraged to be retained. Development maintains consistent streetscape elements, including low scale buildings, small and medium sized front setbacks, and low fencing.
Future residential change category Incremental change	<ul style="list-style-type: none"> In Dow Street, the existing weatherboard dwellings will contribute to a visually interesting precinct, with new building forms emerging. In Esplanade West, continued modern development sits alongside characteristic original weatherboard dwellings. Dual front setbacks in response to the diagonal alignment of the street are continued, and dwellings overlook Lagoon Reserve to the east. 	<ul style="list-style-type: none"> The character of the precinct will be maintained and enhanced through respecting existing setback arrangements and tree planting. In Esplanade West, the small to medium dual setbacks are continued, and verandah and roof elements are referenced. Low fencing and planting is provided. In Dow Street, the strongly prevalent hipped roofs and horizontal lines created through verandah and fascia elements are reflected in new buildings. 3rd floor levels will be discouraged, unless substantially hidden from view. Development adjacent to heritage places will be transitional in height and setbacks.

Design Response	
<i>Frontage widths:</i> Match existing, as follows:	<u>Esplanade West:</u> minimum 6 metres.
	<u>Dow Street:</u> range of 5 – 7 metres.
<i>Siting and setbacks:</i> Match existing, as follows:	<u>Esplanade West:</u> 4 metres; or 2 metre and 5 metre dual setbacks for properties fronting the diagonally aligned section of Esplanade West.
	<u>Dow Street:</u> approximately 3 metres.
<i>Building height:</i>	Two storeys.
<i>Design detail:</i>	<u>Esplanade West:</u> Incorporate verandahs and street surveillance, brick and weatherboard materials, low fences with low planting behind.
	<u>Dow Street:</u> Reflect horizontal elements (eg: verandahs and fascia lines) and hipped roofs, and incorporate brick and weatherboard materials and low / medium fences of open design.
<i>Landscaping / planting:</i>	Low / medium scale planting in the front setback.

Residential Precinct 3: Graham Street (north)

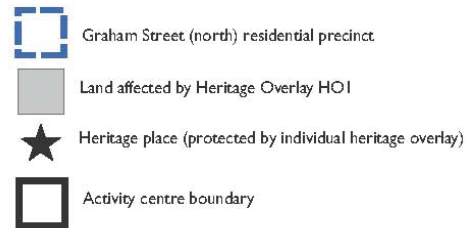

Above: Princes Street



Stokes Street



Graham Street



Nott Street.

Existing type / Future change category	Future Development Statement	Preferred Character Statement
<p>Existing character type</p> <p>Victorian / Edwardian / Modern overbuilding</p>	<ul style="list-style-type: none"> Each street in this precinct has differing established and emerging character attributes which will set the context for future development. Development will respond to the identified character elements of each street, as well as heritage places. The precinct is well located in proximity to the light rail and also the core retail area, which will support incremental intensification. There is scope for further well designed infill development of up to two storeys on remaining larger lots, particularly in Princes Street where townhouse style development is predominant, and also in Nott Street. Properties in Graham Street have generous proportions and can accommodate some development that respects heritage and 'contributory' properties outside of the Heritage Overlay (as shown on the City of Port Phillip Neighbourhood Character Policy Map). Streets with fine grain subdivision elements and small lots, such as Stokes Street, will experience limited development unless lot consolidation occurs. There are atypical taller built form elements of 3 and 4 storeys which act as poor references for future development. 	<ul style="list-style-type: none"> Contemporary development will continue to occur which is respectful of the scale, form and siting of period dwellings. Period dwellings will be encouraged to be retained. New development will respond to the established scale and setbacks of the precinct, and incorporate front setbacks to allow for planting that contributes to the streetscape and rear yard environs. Princes Street will accommodate further townhouse development, with small front setbacks and windows and balconies that overlook the street. Graham Street will accommodate sensitive new development, such as at the rear of period dwellings. Development in Stokes Street will reflect existing character elements, including front and side setbacks, verandahs and low fences. Turville Place and Nott Street will continue to accommodate further low scale multi-unit residential development. New residential development will appear as 2 storeys. A recessed 3rd level can be accommodated in new development fronting Princes and Turville Streets. The housing estate will be updated with contemporary materials and finishes. Any redevelopment will not result in additional height beyond that of the existing buildings.
<p>Future residential change category</p> <p>Incremental change</p>		

Design Response	
<i>Frontage widths:</i>	<u>Princes and Stokes Streets:</u> 5 – 7 metres.
	<u>Nott Street:</u> 6 – 9 metres.
	<u>Graham Street:</u> 6 metres.
<i>Siting and setbacks:</i>	<u>Princes Street:</u> 1 metre front setback.
	<u>Stokes and Nott Streets:</u> 1 - 4 metre front setback.
	<u>Stokes Street:</u> A 0.5 metre side setback.
	<u>Graham Street:</u> 3 – 4 metre front setback.
<i>Building height:</i>	2 storeys (unless specified).
	<u>Graham Street:</u> 3 storeys
<i>Design detail:</i>	<u>Princes Street:</u> Modern design; punctuated facades with openings to both floor levels.
	<u>Stokes Street:</u> Reflect existing elements including gable roof ends, verandahs, low fences.
	<u>Nott Street:</u> Low – medium height fencing.
<i>Landscaping / planting:</i>	<u>Princes Street:</u> Minor decorative planting.
	<u>Stokes & Nott Streets:</u> Low –medium height planting.
	<u>Graham Street:</u> Medium height trees.

Residential Precinct 4: Princes and Stokes Streets

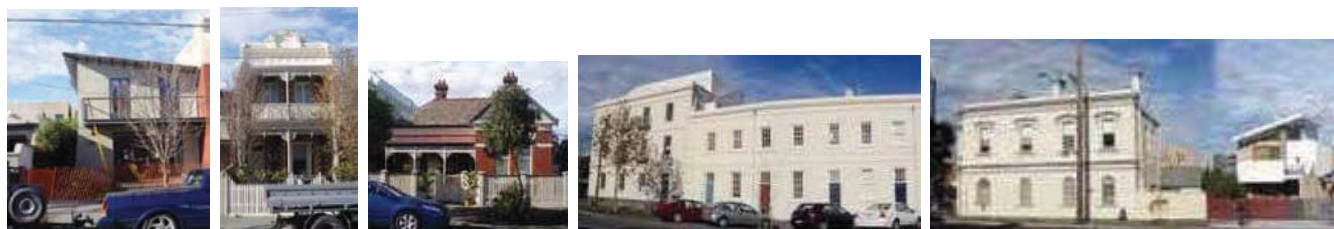
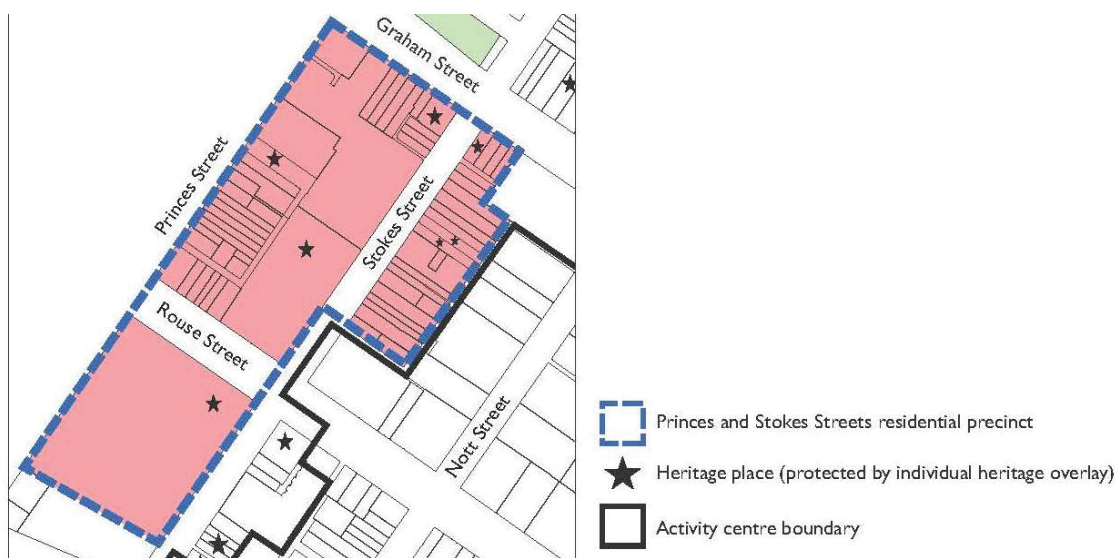

Above: (from L to R) dwellings in Stokes Street, Princes Street, Rouse Street, Graham Street.

Existing type / Future change category	Future Development Statement	Preferred Character Statement
<p>Existing character type</p> <p>Victorian / Edwardian / Interwar Modern overbuilding</p>	<ul style="list-style-type: none"> The precinct is on the edge of a former industrial area that has made a transition to high density residential development. Some medium density development has occurred within the precinct. The precinct has little capacity for further medium density development. Residential lots are typically small in size and will limit further development in the precinct. Stokes and Princes Streets will retain a low scale and fine grain of development, supported by low fences and low planting that contributes to an intimate residential environment. 	<ul style="list-style-type: none"> Period dwellings, including ‘contributory’ properties outside of the Heritage Overlay (as shown on the City of Port Phillip Neighbourhood Character Policy Map), are encouraged to be retained, to protect the low scale, fine grain character of the precinct. Significant and contributory heritage places are retained. The existing rhythm of development is reinforced through new development. A consistent building scale is achieved for each street section, and changes in scale part or mid-way are strongly discouraged.
<p>Future residential change category</p> <p>Incremental change</p>	<ul style="list-style-type: none"> Future development will predominantly be in the form of sensitive additions to existing dwellings, new dwellings on individual lots as they become available, and well-designed low scale medium density development on larger single or consolidated lots. Rouse and Graham Street have some further propensity for change, comprising larger lots and short street sections that have disparate character elements. Heritage places will continue to play a key role in underpinning the unique fabric of the precinct. Intensive development of small individual lots is not envisaged as part of the future character of the precinct. Any further development of the Swallow and Ariel warehouse is set well back from the façade, is limited in height, and visually recessive. 	<ul style="list-style-type: none"> New development responds to the existing characteristics of the precinct, and responds to low scale adjoining properties. New development responds to the setbacks of adjoining properties, and responds to key character elements including the fine grain and characteristic street interface of development, such as setbacks, verandahs, and low fencing. Crossovers, car parking and associated structures will be avoided in the front setback. First and second floor levels are setback from the frontage to limit their visibility. Building scale does not exceed two storeys in Princes Street, and does not exceed three storeys in Stokes Street.

Design Response	
<i>Frontage widths:</i> Match existing, being:	<u>Princes & Stokes Streets:</u> 5 – 9 metres.
	<u>Rouse & Graham Streets:</u> 6 – 7 metres.
<i>Siting and setbacks:</i>	<u>Princes Street:</u> 3 – 6 metres.
	<u>Stokes Street:</u> 1 – 4 metres.
	<u>Graham Street:</u> 6 metres.
<i>Building height:</i>	<u>Princes Street:</u> 2 storeys.
	<u>Stokes Street:</u> 3 storeys.
	<u>Graham Street:</u> 3 storeys
<i>Design detail:</i>	<u>Precinct wide:</u> Respond to fine grain streetscape rhythm, low building scale, planted front setback areas.
	<u>Princes Street:</u> Single storey elements, verandahs, low – medium fencing.
	<u>Stokes Street:</u> Verandahs and balconies, low fencing, brick and weatherboard materials.
<i>Landscaping / planting:</i>	Low to medium size planted front setbacks.