



Heritage Design Guidelines

Revised Feb 2021



This page has been intentionally left blank.

Introduction

Purpose

Heritage places in the City of Port Phillip are highly valued by Council and the community for providing a link to the past and for enriching the present environment.

The purpose of the Guidelines is to provide both Council and property owners or occupiers with clear guidance for decision making in relation to the conservation and the future management and development of heritage places.

The Guidelines follow the philosophy, principles and processes set out in the *Burra Charter, the Australia ICOMOS Charter for Places of Cultural Significance 2013* (Burra Charter).

The aim is not to prevent change, but to ensure that change does not diminish the cultural significance of heritage places over time.

Application

The Guidelines apply to all properties included within the Heritage Overlay in Port Phillip, except for places and areas included on the [Victorian Heritage Register](#). (Please contact Heritage Victoria if your place is included on the Victorian Heritage Register).

All the guidelines apply to Significant or Contributory heritage places, as shown on Council's Heritage Policy Maps.

Some guidelines, including Alterations and additions, New buildings, Car parking, Fencing, Signage, Sustainability and services and Subdivisions, also apply to Non-contributory properties.

How to use the Guidelines

The Guidelines

- Explain what Council will take into consideration when assessing a planning permit application for development or subdivision of land in accordance with Clause 43.01 Heritage Overlay of the Port Phillip Planning Scheme (the 'Heritage Overlay').
- Set out preferred approaches and techniques that will support the achievement of the strategies and outcomes sought by the State and local heritage policy in Clause 15.03 of the Port Phillip Planning Scheme (the 'Heritage Policy').

The Guidelines are not exhaustive. Other approaches may be considered, if it can be demonstrated that the outcomes sought by the Heritage Policy and the Heritage Overlay will still be achieved.

In addition to these guidelines, specific guidelines also apply to the part of Port Melbourne included in the HO2 Garden City Estates Heritage Precinct:

- Dunstan Estate Heritage Guidelines
- Fishermans Bend Estate Guidelines
- Garden City Estate Guidelines

Some Significant heritage places also have specific guidelines, which are contained in the heritage citation for the place.

Process

To ensure a smooth process Port Phillip City Council strongly encourages property owners and developers to discuss any proposals with Council prior to preparing an application for any new development. The following steps are recommended:

1. Find out planning requirements

Speak to a town planner within the Statutory Planning team about planning permit requirements. They can also advise if there are other planning controls, guidelines or policies that you should consider. For example, Rescode.

The Statutory Planning Team can also advise whether your proposal may be eligible for assessment as either a [Vicsmart](#) or [Fast Track](#) application.

Depending on the proposal, general advice may be provided over the phone 9209 6424 or via email (planhelp@portphillip.vic.gov.au), or in person at the St Kilda Town Hall, 99a Carlisle Street, St Kilda (Monday to Friday, 8.30am – 5pm).

2. Prepare concepts

As an initial step, begin to develop some design concepts. When developing these concepts it is important to understand the significance of your property and its setting (also known as the 'context').

The following section *Design in Context* provides advice in relation to the preferred approach to developing a contextual design response that will complement heritage places by respecting and understanding historic significance and character.

This step is not required for [Vicsmart](#) or [Fast Track](#) applications.

3. Discuss concept early

Depending on the proposal, a pre-application meeting may be useful (For information, please see Council's pre-application advice guide).

In some cases, a meeting or site visit with the Heritage Adviser may be necessary. The need for this will be identified as part of the [pre-application advice](#).

4. Prepare an application

Once an approach has been agreed to, prepare your proposal and an application your detailed plans and submit an application. The application should demonstrate how the proposal has responded to the Heritage Policy, Heritage Overlay and these guidelines.

If it is proposed to vary any of the guidelines, then the application should explain how the outcomes sought by the Heritage Policy and Heritage Overlay will be achieved.

For further information about preparing an application, please see Council's website <https://www.portphillip.vic.gov.au/planning-and-building/get-a-planning-permit> or contact the Statutory Planning Team.

Contents

Design in Context

Contextual Design	10
-------------------	----

Guideline 1: Demolition & Relocation

Application	16
Guidelines basis	16
Demolition guidelines	16
Relocation guidelines	17
Case Study 1 - Facadism	18

Guideline 2: Conservation

Application	20
Guidelines basis	20
Repairs and maintenance guidelines	21
Restoration and reconstruction guidelines	22

Guideline 3: Alterations & Additions

Application	25
Guidelines basis	25
General guidelines	27
Height and front setback	27
Side setbacks	36
Form, materials and detailing	37
Case Study 2 - Contemporary residential addition	39

Guideline 4: New buildings

Application	41
Guidelines basis	41
General guidelines	41
Height, form and massing	42
Setbacks	45
Sitting and orientation	47
Fenestration and openings	47
Details, colours, materials and finishes	47
Case Study 3 – Contemporary residential infill	48



Guideline 5: Car parking

Application	50
Guidelines basis	50
Crossovers and driveways	51
Carports and garages	52

Guideline 6: Fencing

Application	54
Guidelines basis	54
General	54
Front fence styles	55
Front fence heights and locations	56

Guideline 7: Signage

Application	58
Guidelines basis	58
Original signage	58
New signs	59

Guideline 8: Significant Trees & Gardens

Application	62
Guidelines basis	62
Working next to trees	63
Replacing trees	63
Gardens	63

Guideline 9: Sustainability and services

Application	65
Guidelines basis	65



Guideline 10: Subdivision

Application	70
Guidelines basis	70
Subdivision guidelines	71

Guideline 11: Public realm and infrastructure

Application	73
Guidelines basis	73
Public realm and infrastructure guidelines	74

Attachment 1: Definitions

Burra Charter definitions	77
Significance definitions	77

The background features a large, abstract geometric composition. On the left, a light grey rectangular area contains the title text. To the right, a large teal shape, resembling a stylized mountain or a series of overlapping triangles, dominates the space. The teal shape is composed of several overlapping triangles in different shades of teal, creating a sense of depth and movement. The overall design is clean and modern.

Design in Context

Contextual Design

Good design in a historic context links the past to the present and projects into the future by demonstrating an understanding and responding to the context of a place¹.

Council encourages a contextual design approach that complements heritage places and their settings by assessing the opportunities and constraints that arise from understanding of historic values and character. The success of new work such as alterations or additions to heritage places or new buildings within heritage precincts will depend upon the sensitivity of the design response. New work should respect the context, strengthen the scale and character of the original, and should not overpower it².

Understanding significance

Contextual design in historic context starts from understanding 'what is significant about a place and why it is significant'. The Statement of Significance, currently in *the Port Phillip Heritage Review*, contains information about the significance of heritage places in Port Phillip. The amount of information depends on the level of significance:

- Significant heritage places have an individual citation that explains why the place is significant.
- Contributory heritage places do not have an individual citation. They form part of heritage precincts, which each have a citation that explains the collective significance of these places.

When preparing an application:

- Consider the most recent Statement of Significance if there is more than one Statement of Significance for the heritage place.
- If there is a Statement of Significance at both the individual and precinct level for the heritage place then both should be considered.

Citations prepared prior to 1998 sometimes have limited information, or the place may have changed since the citation was originally prepared. For this reason, it may be necessary to obtain expert heritage advice to review the information contained in the citation.

Managing transitions

An important part of contextual design is managing transitions between old and new. Successful transition between different building styles and forms requires careful consideration of form, details, scale, proportions, siting and the distinctive 'rhythm' created by traditional fine-grain heritage streetscapes.

For additions, the design response should respect important relationships between the buildings, its neighbours and its setting. New buildings should complement the existing built form while leaving its own legacy for the future.

Contemporary design

Contemporary architecture and innovative design is an important part of the contextual approach because well-designed new work can have a positive role in the interpretation of the cultural significance of a place. The layering of different styles is a defining feature of Port Phillip's heritage. Reproducing heritage styles in new work, particularly in a way distorting historic evidence, is not contextual design.

It is a common misunderstanding that contemporary design means a set of stylistic choices completely

1 Office of the Victorian Government Architect, Good Design and Heritage, page 5

2 Australia ICOMOS, Practice Note, Burra Charter Article 22 – New Work

breaking from the past. What separates a contemporary design approach from that of the modern era is the significance of context when creating new work. Interpretation or interpretive design, for example, is a way of fostering the appreciation of a significant aspect associated with a place by thoughtfully applying present day aesthetics and technology. Simply being different is not interpretive design.



Photo 1: The adaptive re-use of the former Naval Drill Hall (left) and Port Melbourne Post Office (right) for the Albert Park College Environmental Arts Hub included this contemporary insertion linking the two buildings, as well as conservation works to the original buildings. Designed by Six Degrees architects, the complex was the recipient of a City of Port Phillip Design & Development Award in 2018.

Responding to context

To inform your design approach you should prepare a context analysis or a site analysis.

A context analysis considers not only your own site but the broader characteristics of the precinct and streets surrounding it. This is particularly important if your site is in a heritage precinct. However, it may not be required for non-visible alterations or additions at the rear of a dwelling or minor works such as painting. For Significant places that are not within a heritage precinct usually only a site analysis is required, unless the surrounding context is identified as contributing to the significance of the place.

There are three levels of context: precinct, street and your own site. The following explains the key considerations that should be included at each level of your analysis and how this would influence your design. The other contextural considerations applicable to any site, including non-heritage, may not be listed. As always, context differs from site to site. The process of context analysis will help you to identify the other factors that are important for the design outcome.

Precinct

The historic context of the heritage precinct plays a key role in determining the design parameters for additions or new buildings through the characteristics that are not obvious when looking closely around the site. At a precinct level, consider the following:

- **Views and skylines**

At what distance or view point the proposed development will be viewed and experienced? Will the proposed development intrude upon views to landmark buildings or landscape in the precinct? What are the characteristics of the historical skylines found within the precinct and how should the proposed development respond to these?

- **Urban grain**

What are the general size and pattern of the historical land subdivision (also called urban grain) found within the surrounding heritage precincts? Is it regular or irregular? Are there consistent lot sizes?

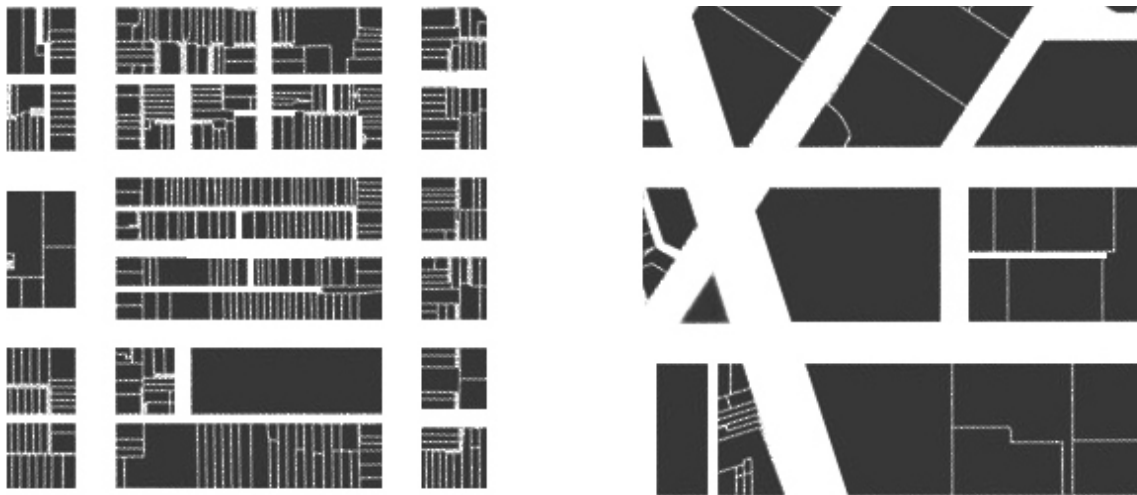

A comparison of the land subdivision pattern between a historic and modern area in South Melbourne.

The figure on the left is part of a heritage precinct which shows a regular fine grained pattern. The one on the right shows the modern urban blocks in the same map scale.

- **Consistency and diversity**

Is the heritage precinct characterised by a consistency of built form or diversity? What are the key features that contribute to the sense of consistency? Or, if diverse, are there any common features such as materials, fenestration patterns, roof forms or otherwise that are repeatedly found in the area?

Street

The primary focus of this level of context is the site and its immediate surroundings which includes the properties within the surrounding streetscapes. A site that can be seen or accessed from multiple streets or a public realm will be assessed from all publicly visible sides.

Consider the following:

- **Setback and orientation**

Do the buildings front the street directly or are they setback from the street? What are the setbacks from the front and side boundaries and are they consistent within the street?

- **Roof form**

Do they have a parapet, if so, is it low or high? Are roofs visible, if so, are they steep (high) or shallow (low) in pitch?

- **Massing, proportion and rhythm**

What is the general height and width of buildings on the street? Are the building proportions predominantly vertical or horizontal? Is there a regular or an irregular pattern created by elements such as windows and ornamentation? Do the buildings have simple or complex forms following specific rules of order?



A typical symmetrical Victorian two storey terrace row with distinctive vertical rhythm created by repetitive verandah bays and detailing.

- **Key features**

Does the street feature verandahs or awnings? Are the windows projected out or recessed?

- **Materials and ornamentation**

What are the prevailing materials and ornamentation used on external surfaces?

- **Fences and gardens**

In residential areas, what are the types of fences traditionally found within the area? What is the typical fence height on the street? How much can the front garden be seen from the street (also called visual permeability)? Are there significant trees and garden features?

- **Driveways and garages**

Are they historically found within the area?

- **Main entrances**

Where are the entrances to buildings located? Do they face toward the front or side, or are they situated on a corner?

For **commercial buildings**, such as shops, additional considerations could include shopfronts and entry: Do the buildings have original shopfronts? Are the buildings entered from the front or the side, a central entry or offset? Are they recessed or in line with the building facade?

- **Signage**

Where is signage located? What form of signage is used?

Site

The story of a building can be read through the manner of its construction and the changes that have been made. Knowing how the building was originally constructed and what changes have happened since (and why) can inform future works. A site analysis considers your property and provides a more detailed description of the key historic features. It can identify features that have been removed and could be restored.

Consider the following:

If your building is **Significant or Contributory**:

- What are the important features of your building and landscape and how could an addition respond to these? For example, the roof form, materials, colours and details.
- Have any original features been removed or changed? Is there an opportunity to restore or reconstruct these? For example, it is unlikely that your property has its original paint finish. A heritage consultant can establish what colour it was originally painted by taking paint scrapes and analysing them under a microscope. Sometimes the original paint finish is visible under joinery, or where more recent coats of paint have started to peel away. You can also check for markings which indicate that a wall has been removed (or added), or mouldings removed from walls or verandah posts.
- What is the best way to incorporate sustainability features to ensure they have minimal visual impacts. Could these be integrated into the design of a new addition rather than be added to the original house?

If your building is **Non-contributory**:

- What are the important features of buildings on adjoining or nearby sites and how could a new building or addition respond to these? For example, the scale, sitting (front and side setbacks), roof form, materials, colours and details.
- If you are undertaking alterations, are there any changes that could make your building sit more comfortably within the streetscape. For example, by changing wall or roof colours or materials, shape or proportions of visible windows or changes to front fencing?

For places that have **social significance**, additional considerations could include:

- Are there buildings and features that are highly valued by the community?
- Is the community attachment to the building or feature itself, or associated more with the use of the place?

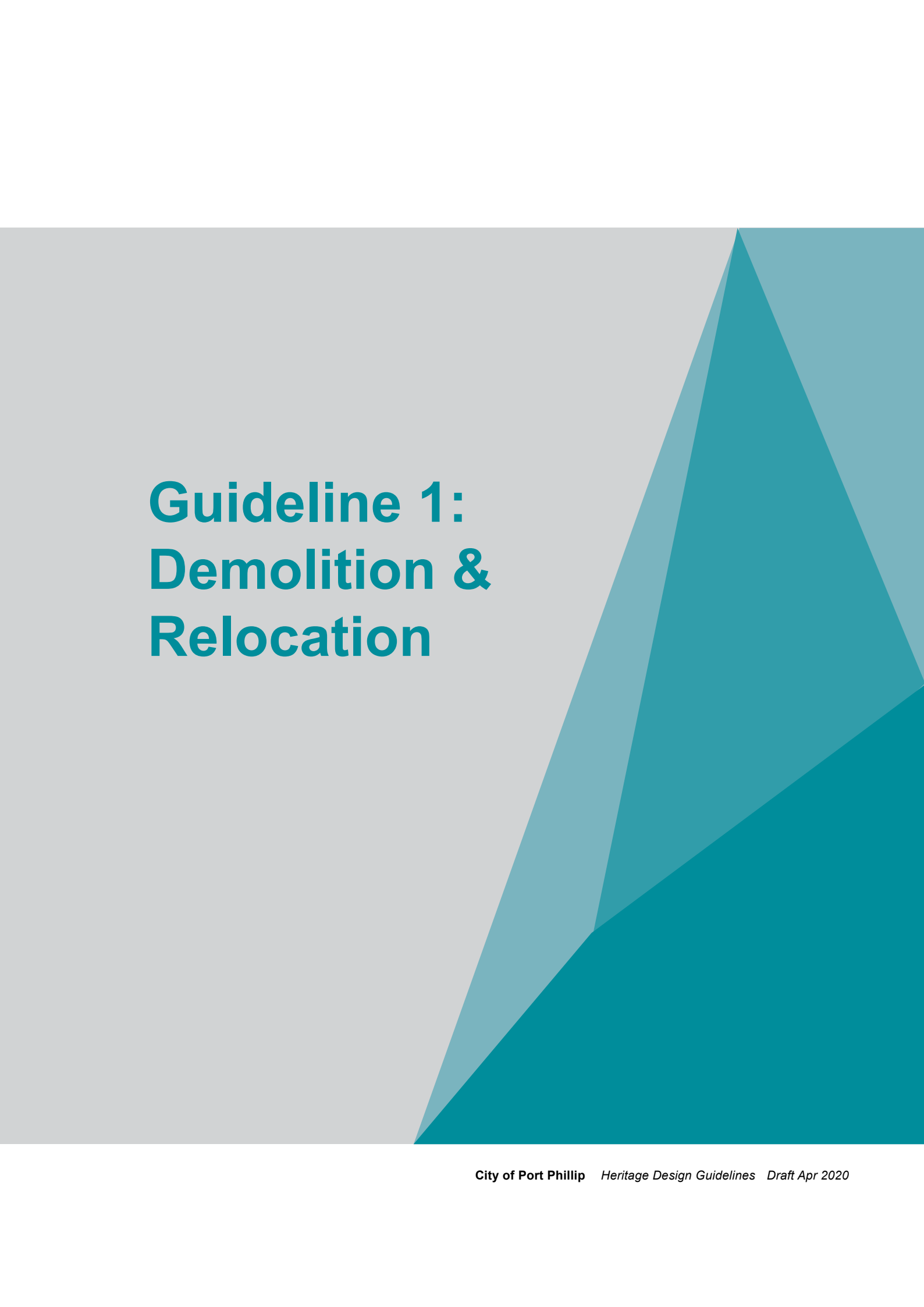
The background features a light grey gradient on the left side, transitioning into a large, abstract teal shape on the right. This teal shape is composed of several overlapping triangles and polygons, creating a dynamic, geometric composition. The overall aesthetic is clean and modern.

Guideline 1: Demolition & Relocation

This section provides guidelines for the complete or part demolition, and for relocation of a heritage place.

Application

These guidelines apply to Significant and Contributory heritage places.

Guidelines basis

Good design will protect existing fabric and understand that heritage significance relates to the building as a three-dimensional form and also carefully considers the impact of demolition upon internal spatial quality and the relationship between the interior and the façade. For this reason, these guidelines strongly discourage full demolition or extensive demolition that leads to ‘facadism’ where, for example, only the external walls are retained (see Case Study 1).

Good design may include part demolition where, for example, the section to be demolished is of no significance or will remove an inappropriate later addition.

Within a heritage precinct, the loss of a single Contributory building may not seem important when considered in isolation. However, the incremental loss over time of buildings or other features that contribute to the significance of the precinct can lead to detrimental impacts upon the integrity and historic character.

The physical location of a place is part of its cultural significance and relocation is generally unacceptable unless this is the sole practical means of ensuring its survival.

Demolition guidelines

For **Significant places**, the extent of demolition will be guided by the Statement of Significance and decided on a case-by-case basis. The aim should be to conserve all buildings and other features identified as contributing to the significance of the place.

For **Contributory places** within precincts, conservation of the building to the depth of at least the front two rooms is recommended. If the building is located on a corner or if there are other publicly visible features beyond the two-room depth then conservation of more of the building may be required. Contributory features such as trees, outbuildings and front fences should also be retained.



Photo 2. The removal of a c.1950s addition at the front of this house in Blessington Street, St Kilda revealed the original intact Victorian era façade. Outlines of the removed walls and some of the colour schemes, as well as the lower sections of the walls (now covered in vines) were left as evidence of this change.

Part demolition may be appropriate if, for example, it results in the removal of fabric that is not significant or detracts from the significance of the building (See Photo 2).

If full or extensive demolition is considered appropriate, the following additional information or actions may be required:

- A visual or documentary record of the building prior to demolition commencing.
- An interpretation strategy that may include on-site information or other methods.
- Conserving any objects or fabric associated with the building that may form part of on-site interpretation, or become part of the historic collection of Council or another organization.

Relocation guidelines

The relocation of a heritage place should be planned and supervised by an appropriately qualified person (or persons) to avoid damage and minimise potential heritage impacts. A relocation plan should be prepared that:

- Identifies a suitable new location.
- Identifies a suitable temporary storage location, if the feature cannot be relocated immediately.
- Identifies the method of disassembly and reassembly, if required
- Identifies the method to be used for photographic and documentary record of the building or feature on its current site prior to relocation.
- Identifies how the relocation procedure will be supervised and managed to avoid inadvertent damage to or loss of fabric.

A similar process may be followed if it is proposed to temporarily remove and reinstate a heritage place in the same location.

Council may require the payment of a bond or guarantee to ensure the relocation is carried out in accordance with the plan.



Photo 3: The Maskell and McNab Memorial was unveiled on 17 July 1890 in memory of two Port Melbourne residents who were killed in the infamous Windsor rail collision of 11 May 1887. Originally located near the Graham Street Railway Station, it has been relocated on three occasions. It now resides on the foreshore reserve in Beach Street near Princes Street.

Case Study 1 - Facadism



This building in Spitalfields, London shows the adverse visual impacts of 'facadism' upon the significance and integrity of a building. Not only has the historic building been reduced to just the front wall, but original details such as windows and doors have been removed and there is no visual or physical relationship with the new building behind, which is a completely separate structure. This demonstrates the importance of maintaining buildings as three-dimensional objects by retaining original visible fabric beyond the front wall and ensuring that new additions respond to and reinforce aspects such as floor to floor height, depth of space, and building form and layout.

The background features a large, abstract geometric composition. On the right side, there are several overlapping triangles in various shades of teal and blue, pointing towards the top right. The left side of the page is a solid light grey. The text is positioned on the grey background.

Guideline 2: Conservation

This section provides guidelines for the conservation of features, details, materials, and finishes that contribute to the significance of heritage places including:

- Maintenance and preservation.
- Minor repairs.
- Restoration by reinstating original fabric or by the removal of inappropriate additions.
- Reconstruction to a known earlier state using new or introduced material based on historic evidence.

Application

These guidelines apply

- For Significant places, to all features, details, materials, and finishes that contribute to the significance of the place.
- For Contributory places, to all contributory features, details, materials, and finishes that are visible from the public realm.

Guidelines basis

Designers of buildings during the late nineteenth and early twentieth centuries applied a range of decorative styles to buildings, which reflected the use and function of the building as well as the status of the owner. These styles were expressed by a range of external decorations and finishes such as render, mouldings, cast and wrought iron and timber decoration, tiles, glass, tuck-pointing and paint.

Heritage colour schemes were based on the identification of various parts and elements of the building's structure and decoration. They employed a limited range of external colours up to World War Two (1939) and although new colours became available in the Interwar years (1919 to 1939), tradition resulted in the early colours still being commonly used. Traditional schemes were quite colourful given their limited range, but relied mainly of tonal contrasts rather than changes of hue. Brickwork, stone and render were intended to be naturally finished and were not painted.

Many buildings in Port Phillip are notable for the intactness of many of these features (see Photo 4) and for the consistency of decorative approaches that have been used. Conservation of these features is therefore essential to maintaining the significance of the heritage places and precincts in Port Phillip.

Regular maintenance is important to conserve the appearance and significance of external finishes and decoration. However, it is important to understand that, in some cases, a special approach may be required to ensure that finishes or decorations are not inadvertently damaged.

When buildings have been altered, the restoration or reconstruction of contributory features can reveal the heritage values of the place and contribute to an improved understanding about its history and significance.



Photo 4. This block of flats in Wimbledon Avenue retains original finishes including the clinker brickwork, which contrasts with the natural (unpainted) render.

Repairs and maintenance guidelines

Repairs and maintenance should match the material, colour, texture, composition and pattern of the original. This is known as 'like for like' replacement. The emphasis should be on small scale repair and maintenance, rather than complete replacement wherever possible.

For example:

- For timber houses, weatherboards should be the same have the same profile (see Figure 2.1) and size (width of profile) as the original.
- Edwardian houses often have unglazed terracotta tiles with a 'Marseilles' profile, and should be replaced with tiles in the same material with an identical profile.

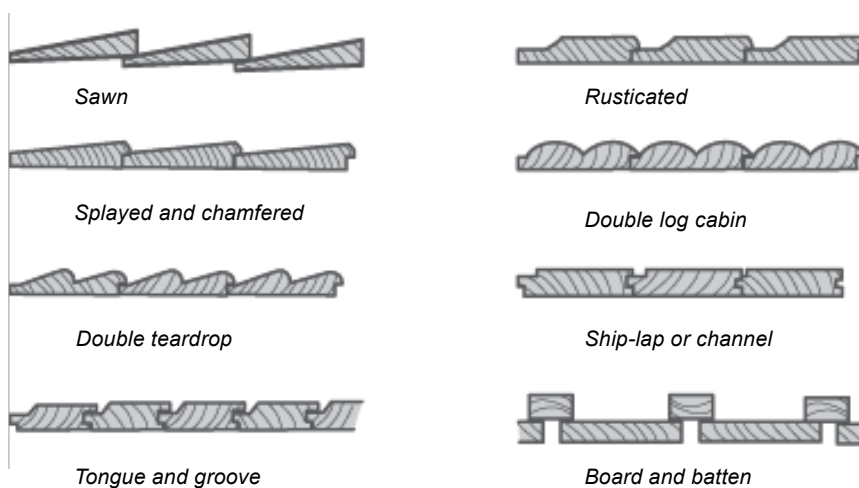

Figure 2.1 Common timber cladding profile

Seek advice from Council's Heritage Advisor about the best techniques to avoid damage when carrying out any conservation works. Avoid techniques such as sandblasting that could damage heritage features, details, materials or finishes.

For techniques such as paint removal or render repair, it may be necessary to carry out tests on a small non-conspicuous area first before proceeding.

Restoration and reconstruction guidelines

Restoration means returning the fabric of a heritage place to a known earlier state by removing non-original additions or restoring existing original features without the introduction of new material.

Reconstruction is a similar process to restoration, but differs as it includes the introduction of new materials.

Restoration or reconstruction of missing or altered features should be based on physical or documentary evidence:

- Physical evidence could include remnant fabric within the host building (for example, an original window frame concealed within a wall) or on an adjoining building if it forms part of a group of related buildings (for example, original cast iron frieze on an adjoining terrace house).
- Documentary evidence could include building plans, photographs, newspaper articles and the like. Oral history may also be considered.

If there is not enough evidence for an accurate reconstruction, then a simplified design appropriate for the style of the building should be used.

Avoid the incorrect use of traditional details or materials or adding a feature that never existed. For example, simple timber Victorian cottages usually did not have ornate cast iron verandahs, and some commercial buildings such as hotels and banks never had a verandah or awning (see Photo 5).



Photo 5. The reconstruction of historic verandahs in Clarendon Street did not include buildings such as this former bank that never had a verandah

Sometimes, later additions can contribute to the significance of a heritage place and should be conserved as a record of the historical layers.

Some examples include:

- Interwar shopfronts to Victorian or Edwardian shops (see Photo 6).
- Alterations and additions to mansions or houses that have been converted to flats.
- Alterations and additions to Victorian era hotels as part of upgrades to meet new liquor licensing laws in the early twentieth century.

An exception could be if there are heritage guidelines specifically for the place that recommend returning the place to its original state.



Photo 6. These shopfronts, added during the interwar period, contribute to the historic character of the Victorian era shops in Clarendon Street, South Melbourne.

Colours and finishes

Original colour schemes should be repainted using the same colours.

Where original colour schemes have been lost, authentic colour schemes may be recreated by:

- Undertaking physical analysis such as paint scrapes of key features to determine the original colours used.
- Developing a new scheme based on typical colour schemes for the architectural style and detailing.

Unpainted surfaces should remain unpainted. This includes rendered finishes with original integrated colour.

Carefully remove paint from originally unpainted surfaces such as brickwork and render by an approved method that does not damage the fabric. Council's heritage advisor can provide further advice.

For more information see [Heritage Practice Note 3 Heritage Colour Schemes](#).

Associated objects and machinery

Wherever possible, original objects and features such as historic machinery should be retained in their original place. If this is not possible, then they may be relocated if this is the only means of conserving the object or feature. Interpretation may be required.

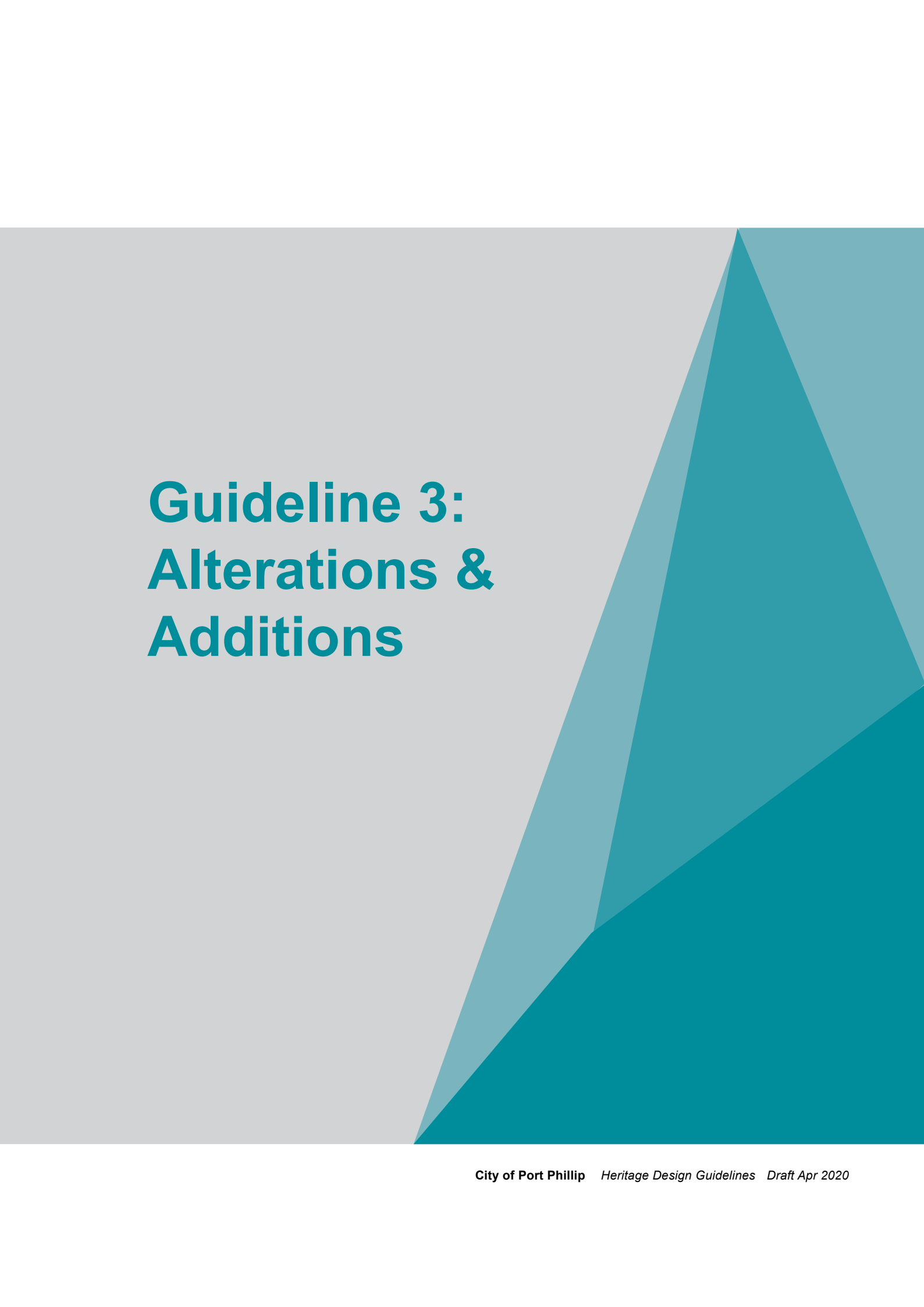

Guideline 3: Alterations & Additions

This section provides guidelines for alterations and additions to existing buildings.

Guidelines for new development (that is, an entirely new building) are discussed in the following section.

Application

These guidelines apply to all properties.

Guidelines basis

The heritage places and precincts in Port Phillip illustrate the historic development of the city from the mid-nineteenth century onwards. Some heritage precincts, such as those in Albert Park, Middle Park, Port Melbourne, South Melbourne and parts of Elwood have a more consistent heritage character (see Photo 7), while others, particularly those in St Kilda and parts of Elwood, have a more diverse character, which illustrates successive waves of development (see Photo 8 & 9).



Photo 7. An example of a consistent residential streetscape

This has created streetscapes that are significant for the high degree of intactness and consistency in terms of style, form, scale and sitting such as HO442 Albert Park Residential, as well as those that are highly diverse such as HO5 St Kilda Hill.

The same is true of individual heritage places with some developed in only one period, while the fabric of others show layers of historic development.

Alterations and additions to buildings should be guided by significance, and care must be taken to ensure that they do not have an adverse impact upon the historic character of heritage places and precincts. This includes additions to Non-contributory buildings within heritage precincts.



Photo 8. An example of a diverse streetscape consisting of various Contributory places



Photo 9. An example of diverse streetscape consisting Significant and non-Contributory places.

General guidelines

Significant places

For Significant places, avoid alterations or additions that would alter, conceal or remove contributory features whether or not they are visible from the public realm.

Contributory places

For Contributory places, avoid alterations or additions to the façade or other elevations that are visible from the public realm including a lane if the building is located on a corner. Specifically, avoid alterations or additions that would:

- Replace, alter or remove original features, materials or finishes (for example, replacement of timber windows with aluminium)
- Enclose original verandahs, balconies or porches.
- Create new openings or enlarge existing ones in visible walls.
- Result in new floor plates, walls, columns or structural supports cutting through visible openings.
- Retain only external walls.
- Introduce roof decks, balconies or dormer windows in visible locations.
- Interfere with a view to a building or feature that contributes to the significance of a heritage place.

New work should be distinguishable from old, while being sympathetic with the significant fabric. This can be achieved by:

- Making new material recessed or providing a clear visual break between old and new.
- Using a similar material, but with a different texture, or using a similar, but simplified design.
- Avoiding inappropriate contrasts between old and new fabric.
- Avoiding the use of faux historic detailing.

Non-contributory places

For Non-contributory properties, alterations that change the appearance of the building are permitted.

Height and front setback

The height of the addition and front setback is guided by the degree of concealment encouraged by the Heritage Policy.

In determining the degree of concealment required for new work, the Heritage Policy has regard to:

- The level of significance of the building (Significant, Contributory or Non-contributory) and,
- When the property is located within a heritage precinct, the consistency or diversity of the streetscape.

In determining whether a streetscape is consistent or diverse, consider only the buildings on the same side as the subject building and within the immediate surrounds.

Other considerations include:

- Whether the site is elevated above the street.
- Whether the roof of the proposed addition has a sympathetic contextual form (for example, a hipped form if the original house has a hipped roof or where this is a characteristic of the area).
- Whether oblique views are limited, for example, by higher buildings on adjoining or nearby sites

- Whether the roof form or height, parapet or any other feature of the existing building will assist in concealing the addition.
- Whether the addition will be seen within the context of taller buildings visible in the background.

Visible additions may be considered when the heritage place is situated on a site or within an area where higher density development is encouraged, or the additions are in accordance with specific development guidelines for the heritage place.

Areas where higher density development is encouraged include some that are within a Design and Development Overlay.

Examples of visible additions are the high-rise buildings constructed behind historic mansions in St Kilda and Queens Roads, and in the adaptive re-use of industrial buildings in South Melbourne and Port Melbourne (see Photo 1).

Residential Additions

The following guidelines are designed specifically for single residential buildings (one dwelling on a lot). Additions to multi-unit buildings (flats or apartments) will be assessed on a case-by-case basis having regard to the significance of the building and the context.

For additions to single middle-block residential buildings:

- Full concealment for a Significant place or in a consistent streetscape (See Photo 7) as encouraged by the Heritage Policy may be achieved by within a 10 degree sightline as shown in Figure 3.1 or by using 'across the street' sightlines as shown in Figures 3.2, 3.3 or 3.4.
- Partial concealment in a diverse streetscape (See Photo 8 & 9) as encouraged by the Heritage Policy may be achieved by containing the addition within a sightline of up to 18 degrees as shown in Figure 3.5. The significance of the heritage place and the streetscape context will determine the extent of the variation from 10 up to 18 degrees.
- For houses with complex roofs, additional considerations apply, as shown in Figure 3.9.

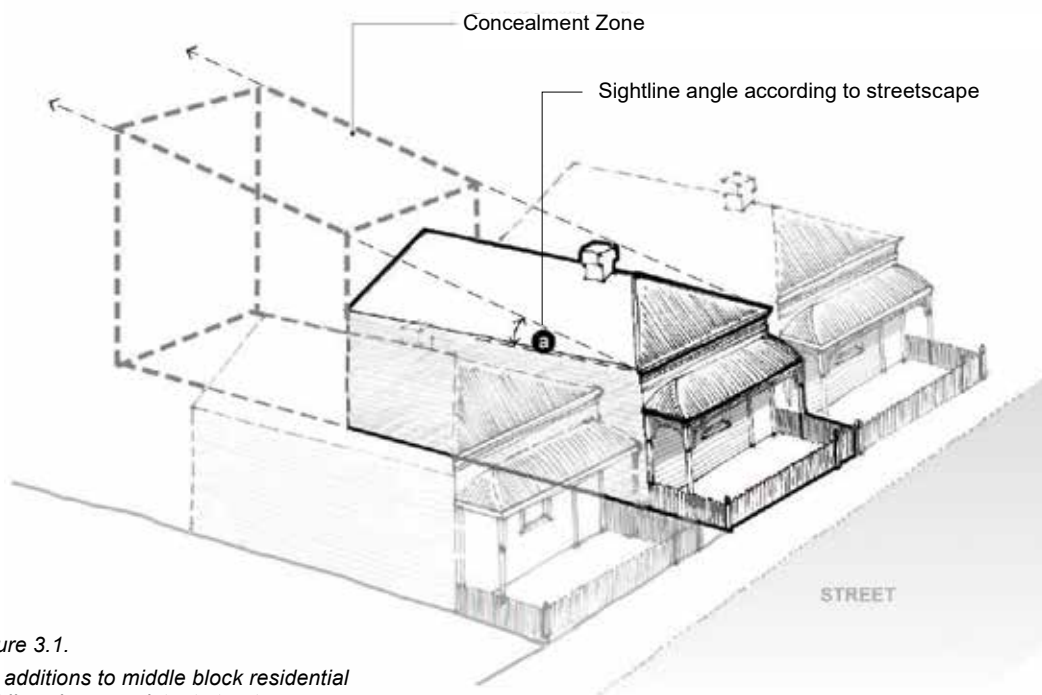

Figure 3.1.
For additions to middle block residential buildings in a consistent streetscape.

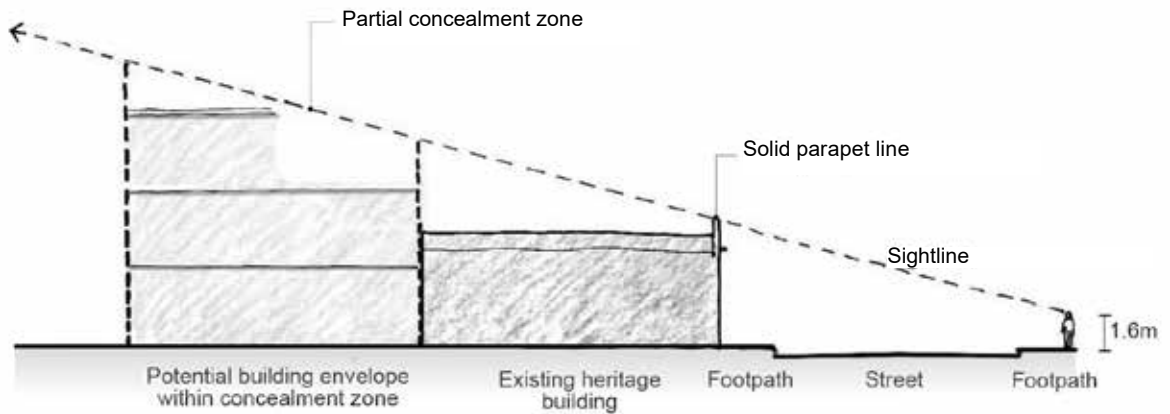

Figure 3.2.
Across the street sightline for single storey residential buildings with a front parapet.

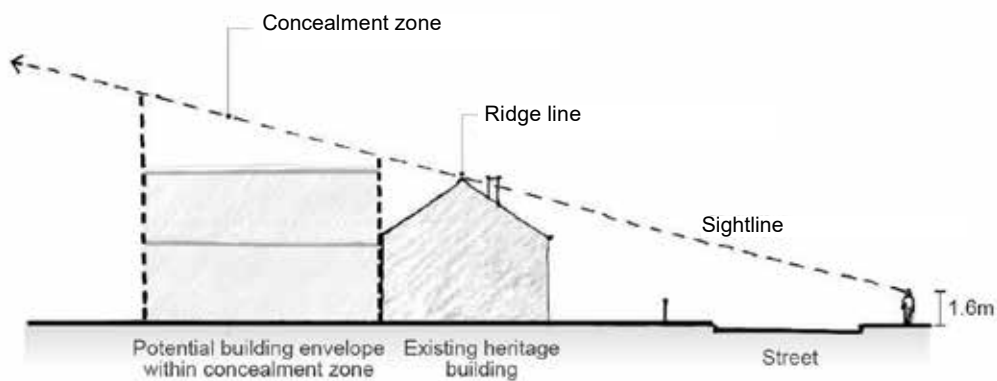

Figure 3.3.
Across the street sightline for houses with a ridgeline that is parallel to the street (known as a transverse ridge).

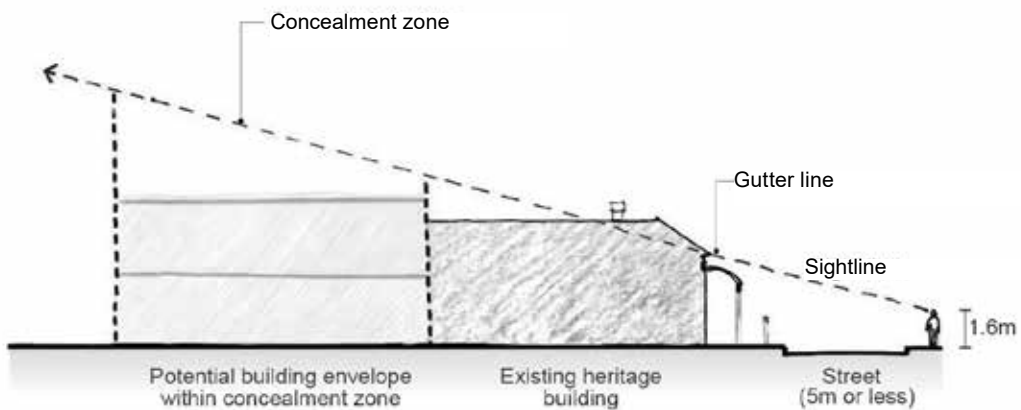

Figure 3.4.
Across the street sightline for residential buildings in narrow streets (5 metres or less in width)

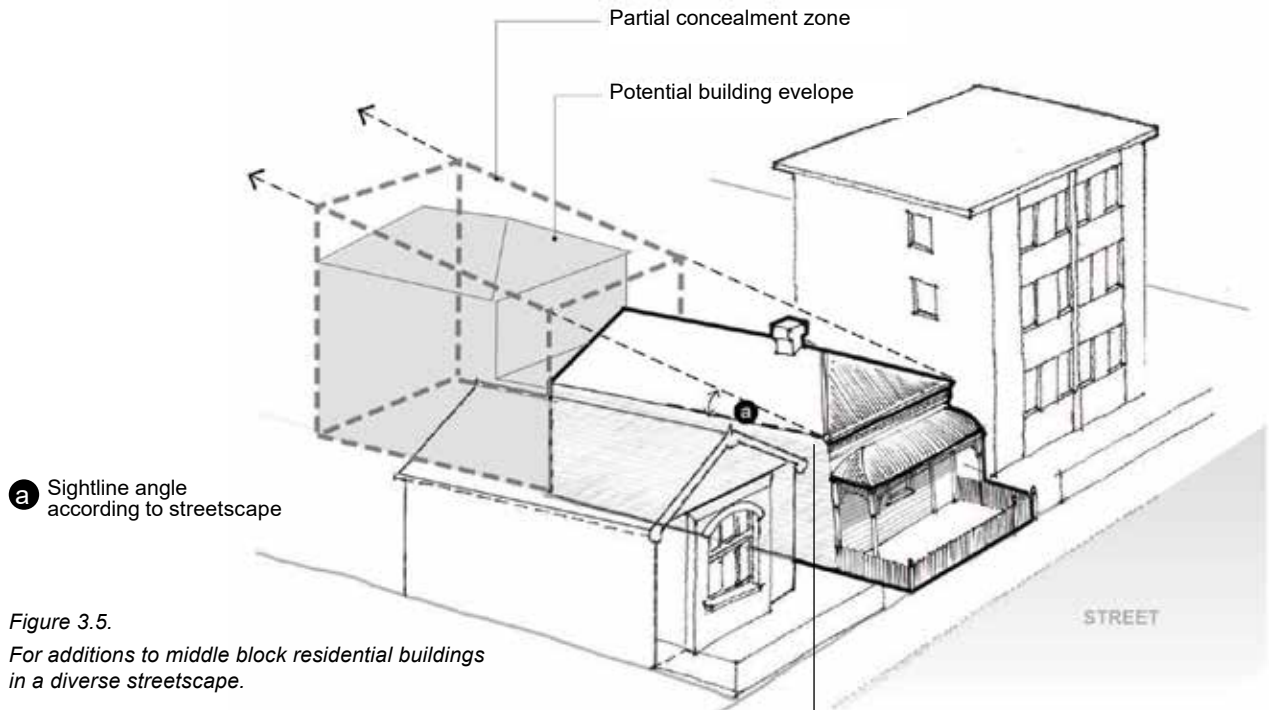

Figure 3.5.
For additions to middle block residential buildings
in a diverse streetscape.

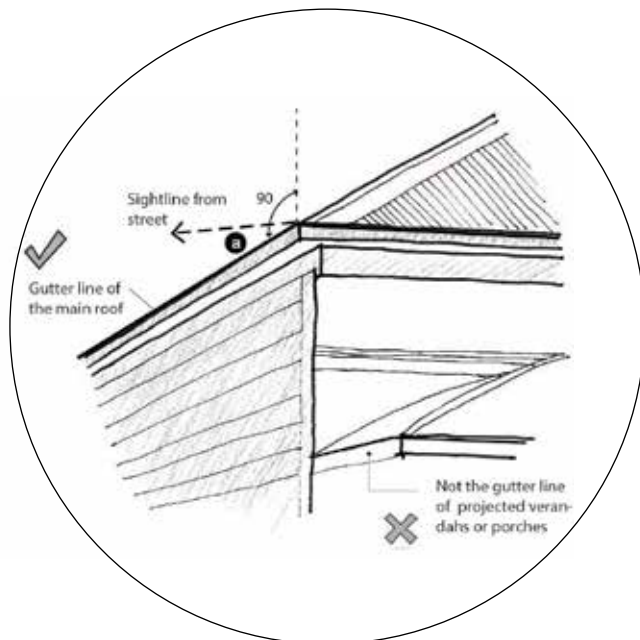

Figure 3.6.
Sightline is measured from the top of the gutter
line at the corner of the main roof, and not from
the projecting front bay, porches or verandahs.

For additions to corner buildings:

Additions on corner sites can be potentially viewed from multiple streets or public realms. Because of this, simply assessing it from primary street will not always result in an acceptable outcome and the following additional considerations apply:

- Apply sightline of between 10 and 18 degrees depending on the consistency or diversity of the primary street frontage.
- Ensure the addition responds sympathetically to the host dwelling and does not visually overwhelm or detract from it, as shown in Figure 3.8, or Figure 3.9 for houses with complex roof forms.

- Where the side streets has a consistent or valued character, ensure the addition also responds to such streetscape including the form, massing, siting, materials of the Contributory places. Examples of corner sites where this applies are shown in the Figure 3.7a.

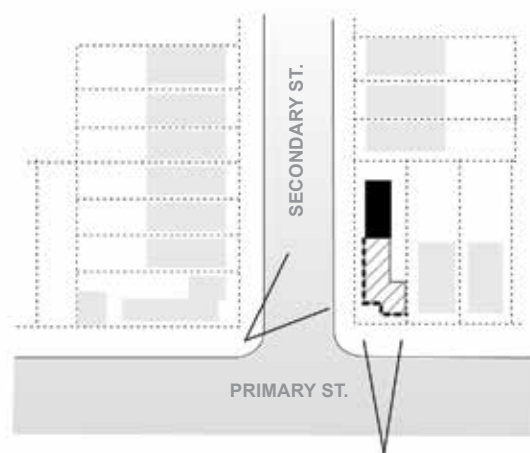

Figure 3.7a

- In the examples as show in Figure 3.7b, the addition must also respond to the laneway which opens up views to the rear of the addition, and provides visual separation from the adjoining houses.

-  Existing heritage place
-  Example of new addition
-  Significant frontage
-  Neighbouring buildings
-  Views

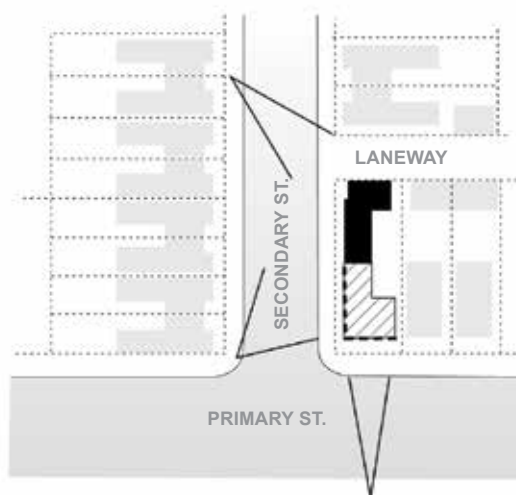
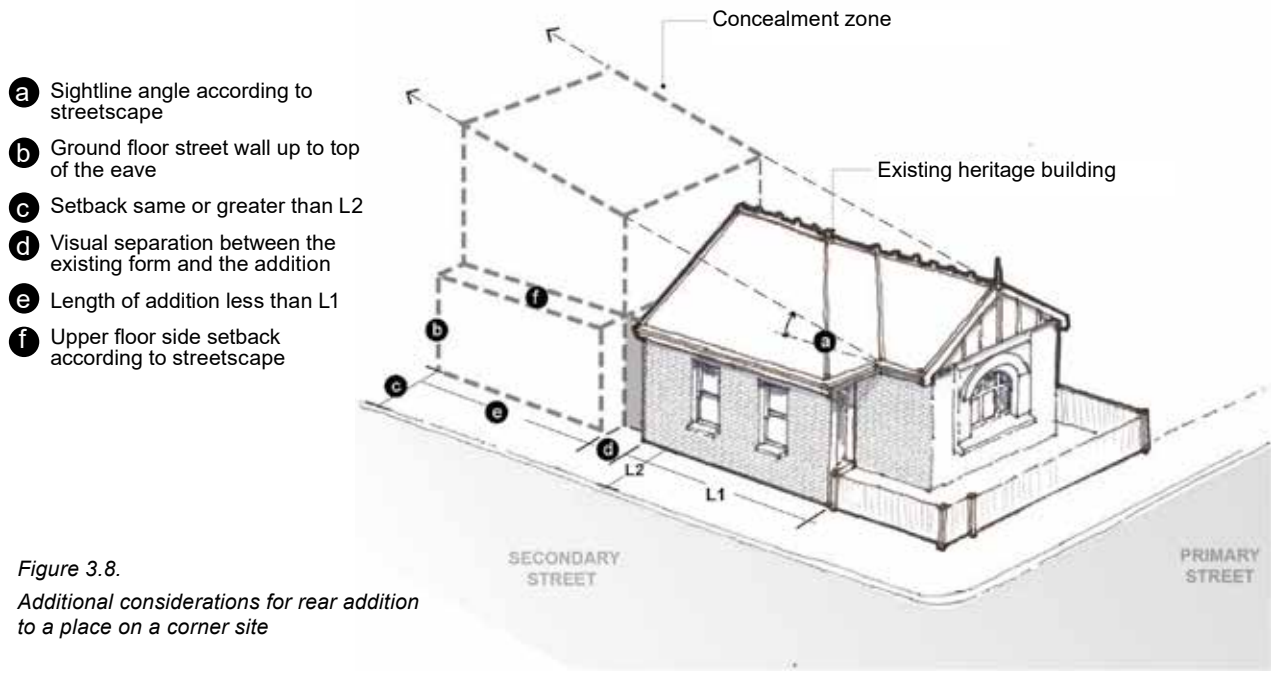
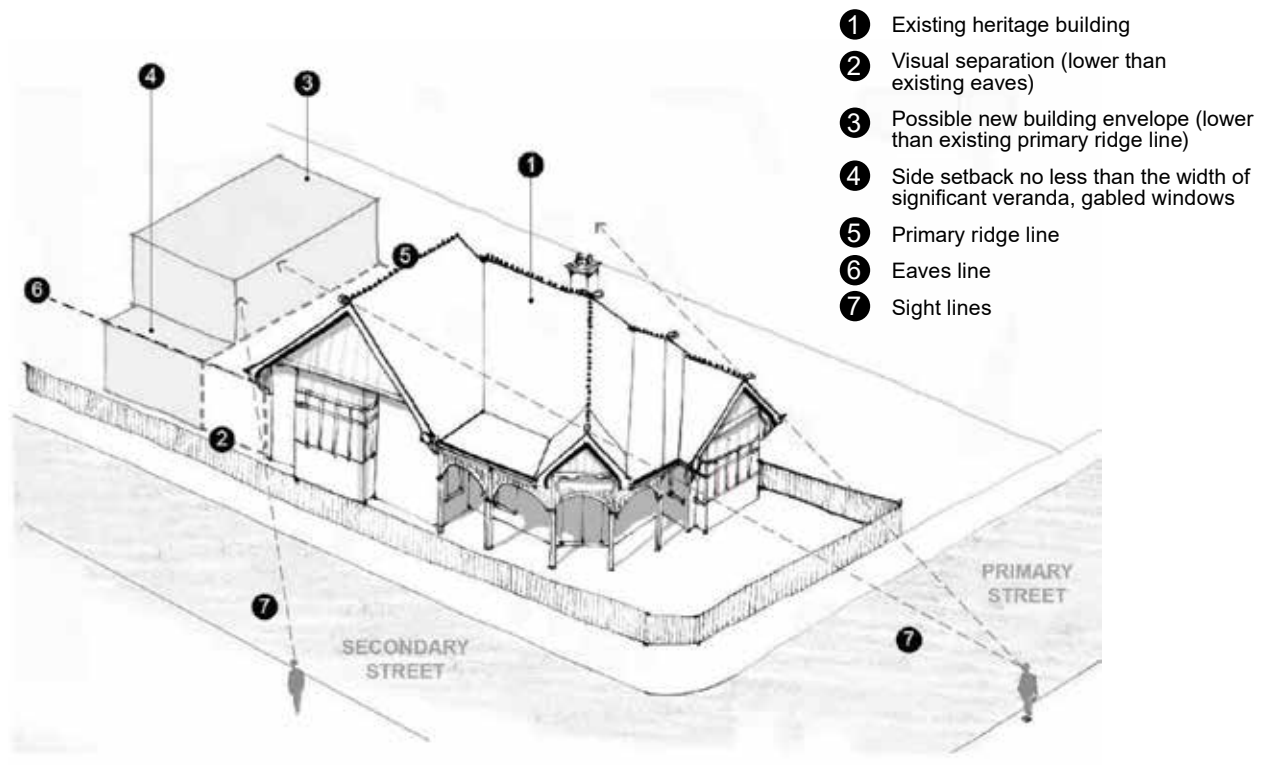

Figure 3.7b



- a Sightline angle according to streetscape
- b Ground floor street wall up to top of the eave
- c Setback same or greater than L2
- d Visual separation between the existing form and the addition
- e Length of addition less than L1
- f Upper floor side setback according to streetscape

Figure 3.8.
Additional considerations for rear addition to a place on a corner site



- 1 Existing heritage building
- 2 Visual separation (lower than existing eaves)
- 3 Possible new building envelope (lower than existing primary ridge line)
- 4 Side setback no less than the width of significant veranda, gabled windows
- 5 Primary ridge line
- 6 Eaves line
- 7 Sight lines

Figure 3.9.
Additional considerations for houses with complex roof forms. This applies to properties on corner sites, as shown, as well as in mid-block locations.

Commercial additions

More specific guidance may be provided through alternate planning controls (such as a Design and Development Overlay). Where this is the case, the following guidelines will not apply.



Photo 9. An example of a consistent commercial streetscape in Clarendon Street, South Melbourne



Photo 10. An example of a diverse commercial streetscape in Bay Street, Port Melbourne

For commercial buildings:

- Full concealment of additions to a Significant place or any building in a consistent streetscape (see Photo 9) as encouraged by the Heritage Policy may be achieved as shown in Figure 3.10 or 3.11.

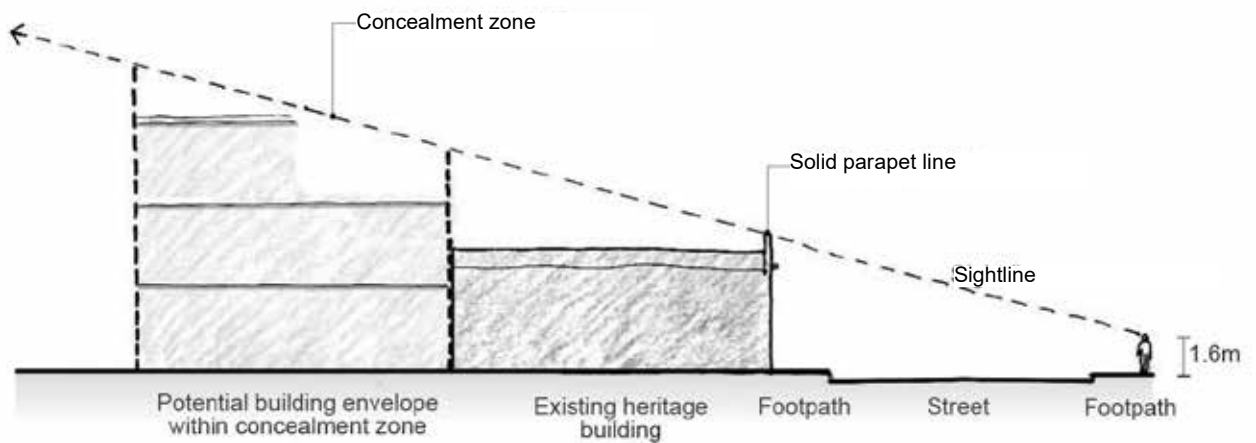

Figure 3.10. Sightline to achieve full concealment behind a Significant building or to any single-storey building in a consistent streetscape.

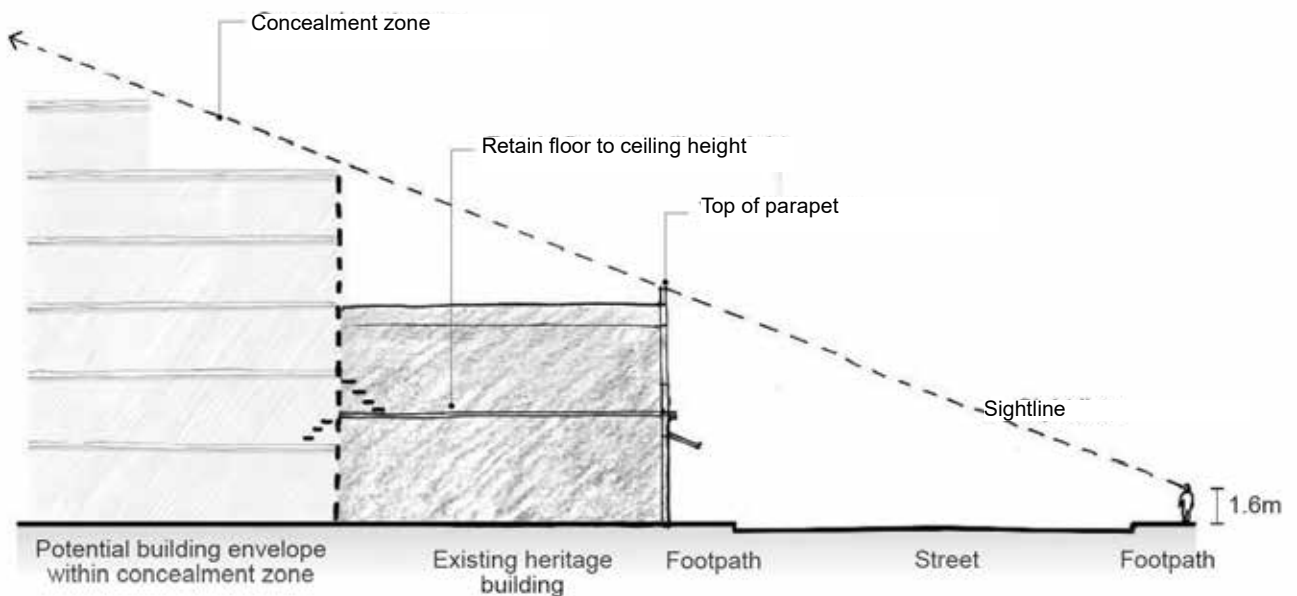

Figure 3.11. Sightline to achieve full concealment to a Significant building or any double-storey building within a consistent streetscape.

Alterations & Additions

- Partial concealment of additions to a single storey Significant or Contributory heritage place in a diverse streetscape (see Photo 10) may be achieved as shown in Figure 3.12.
- Additions to single storey Non-contributory buildings in a diverse streetscape are shown in Figure 3.13.
- Additions to Non-contributory buildings of greater than one storey will be determined on a case by case basis having regard to the streetscape context.

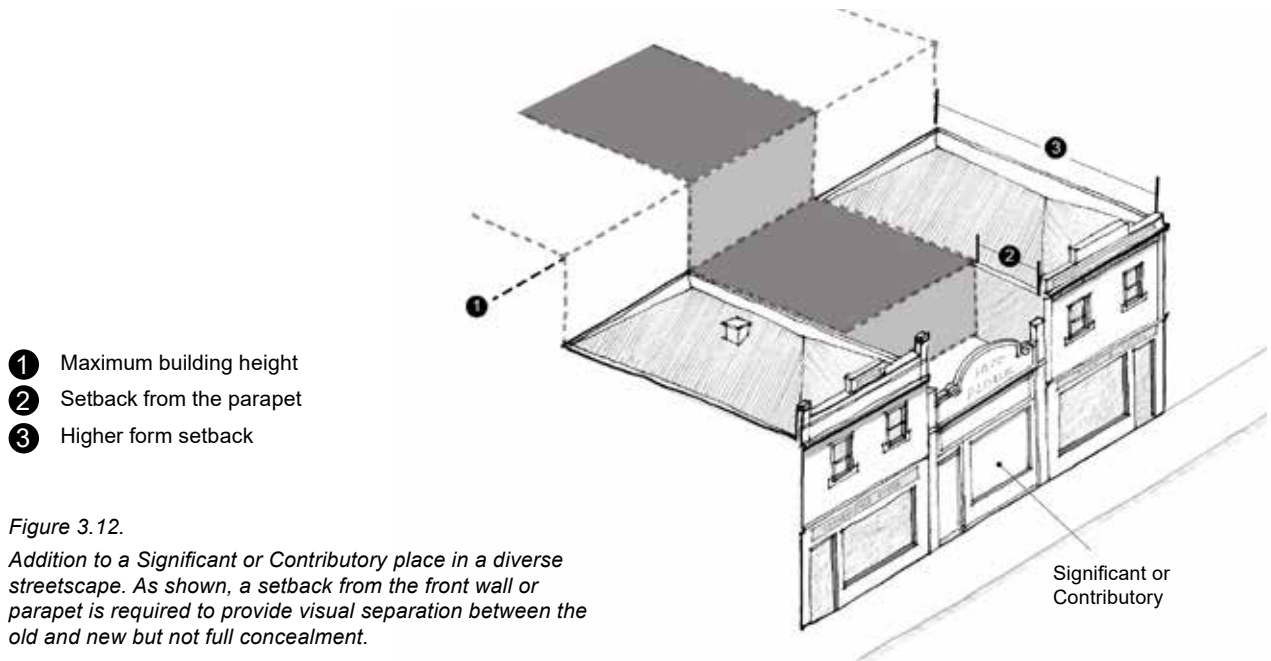

Figure 3.12.
Addition to a Significant or Contributory place in a diverse streetscape. As shown, a setback from the front wall or parapet is required to provide visual separation between the old and new but not full concealment.

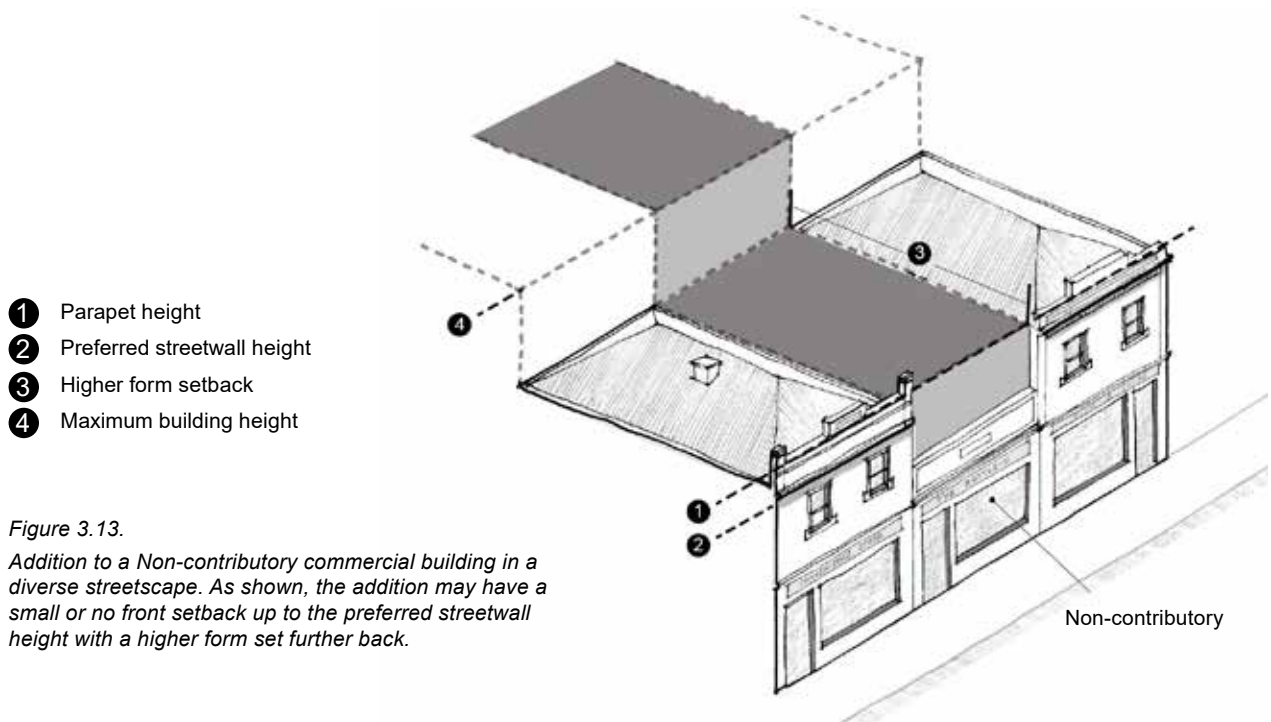

Figure 3.13.
Addition to a Non-contributory commercial building in a diverse streetscape. As shown, the addition may have a small or no front setback up to the preferred streetwall height with a higher form set further back.

Side setbacks

For residential buildings, additions higher than one storey should have the same as or greater side setbacks than those of the original building.

A single storey addition may have a lesser side setback than the original building if:

- It is sited behind the original building at ground floor, or
- If located at the side of the original building, it is no higher than the eaves height and is setback from the façade to minimise visibility from the street. The additional considerations are shown in Figure 3.14.

For current or former industrial and commercial buildings, the side setbacks should be the same or greater than the original building, unless there are specific guidelines recommending a different approach.

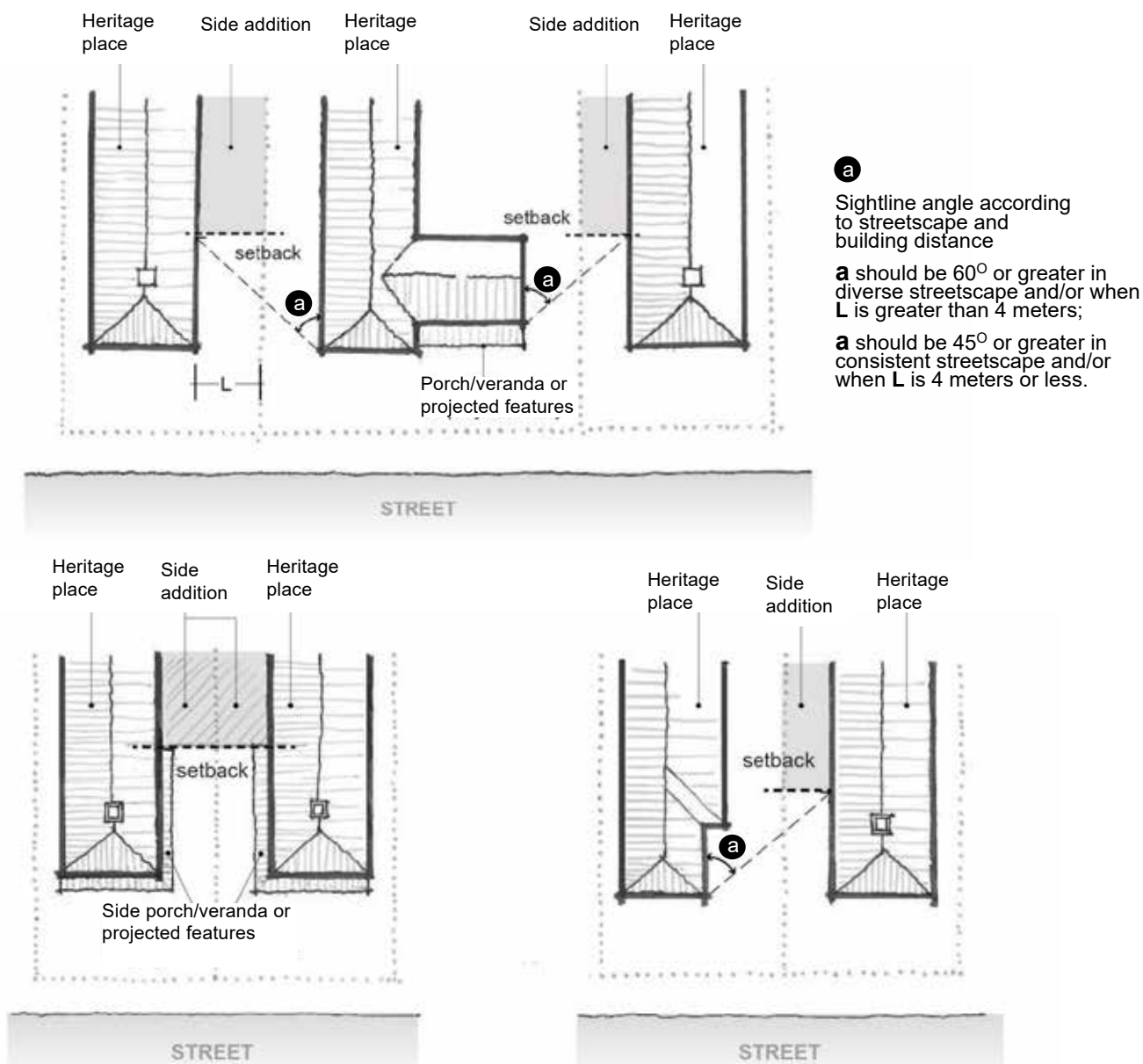

Figure 3.14

Additional considerations for single storey addition located at the side of the original building.

Form, materials and detailing

Residential additions

For residential buildings, where an addition will be visible from the public realm, a contextual design response is encouraged that:

- Has a roof with a form and material that is related to the heritage place (see Cover image).
- Uses colours, materials and finishes that complement the heritage place (see Photo 11).
- Integrates environmental sustainability features or buildings services.
- Avoids openings in walls facing the frontage of the property.



Photo 11. An extension featuring Hello wall by architect Fooi-Ling Khoo and graphic artist Rose Nolan. This design elevates a practical solution for privacy by creating "Hello" out of fine brickwork. It also showcases how contemporary design can contribute to the brick tradition of its 19th century heritage neighbours.

Where an addition is concealed using one of the techniques shown in Figures 3.2, 3.3, 3.4 or 3.5 there is more flexibility to create a different identity of its own (See Case Study 2).



Photo 12. Lightweight material and simple details used for an office addition above a Federation era factory of local significance in Cremorne Street, Richmond.

Commercial and retail additions

For commercial and retail buildings, where an addition will be visible from the public realm, a contextual design response is encouraged that:

- Has articulation, fenestration and massing that respects the proportions and grain of the heritage place and streetscape. For additions to Victorian and Edwardian buildings or within streetscapes with this character vertical proportions are encouraged.
- Uses colours, materials and finishes that complement the heritage place. Specifically, the use of visually lightweight materials that provide a contrast with the solid masonry façades of heritage places is encouraged (see Photo 12).
- Is simply detailed to avoid competing with the often more elaborate detailing of the heritage building.
- Avoids the use of reflective materials or glazing.

Where an addition is concealed using one of the techniques shown in Figures 3.10 or 3.11 there is more flexibility in design.

Case Study 2 - Contemporary residential addition



Photo 14. Front view of 105 Richardson Street, Albert Park.

The contemporary addition to this house is located within the 10 degree sightline and therefore is not visible when standing directly in front but is visible from the side laneway.



Photo 15. Corner view (right) and close up (left) of 105 Richardson Street.

Although the contemporary addition does not have a pitched roof form, the design, sitting and curved form ensures that it is a recessive element that reads as separate from the original dwelling and does not overwhelm it. Consistent with the guidelines for corner sites, the addition incorporates a recessed visual break between the original house and the addition, a ground floor wall set on the boundary and below the eaves height of the original wall, setbacks from the side boundary for the upper level, and uses contemporary colours and materials that complement the face brick and slate tiles of the original.



Guideline 4: New buildings

This section provides guidelines for the construction of new buildings within heritage precincts or on a site containing a heritage place.

Application

These guidelines apply to all properties.

Guidelines basis

The heritage places and precincts in Port Phillip illustrate the historic development of the city from the mid-nineteenth century onwards. Some heritage precincts, such as those in Albert Park, Middle Park, Port Melbourne, South Melbourne and parts of Elwood have a more consistent heritage character, while others particularly those in St Kilda and parts of Elwood have a more diverse character, which illustrates successive waves of development.

This has created streetscapes that are significant for the high degree of intactness and consistency in terms of style, form, scale and sitting such as HO442 Albert Park Residential, as well as those that are highly diverse streetscapes such as HO5 St Kilda Hill.

The same is true of individual heritage places with some comprised of buildings from only one period, while others show layers of historic development.

New buildings within an historical context should complement the significant heritage character and leave a valuable legacy for the future. They can successfully provide for modern demands within an historic context by respecting and interpreting heritage character without overwhelming it.

General guidelines

In consistent streetscapes, new buildings should closely reflect the following characteristics of Significant and Contributory places:

- Height, form and massing
- Setbacks
- Sitting and orientation
- Fenestration and openings
- Details, colours, materials and finishes
- Fence height and form

For commercial and retail buildings, the form, proportions and details of nearby original or early shopfronts and verandahs or awnings should also be considered.

If the streetscape is more diverse then there is more flexibility for an interpretive design that responds to characteristics such as overall massing, proportions, materiality and form.

Height, form and massing

Residential infill

As shown in Figure 4.1, in a **consistent streetscape** new buildings should:

- Not exceed the maximum height of buildings on adjoining lots but may incorporate a higher section at the rear, if it is recessive and does not dominate the heritage place.
- Use a contextual approach that respects the following characteristics, as appropriate:
 - > Building proportions
 - > Wall height/gutter line
 - > Roof form and height
 - > Verandah form and height

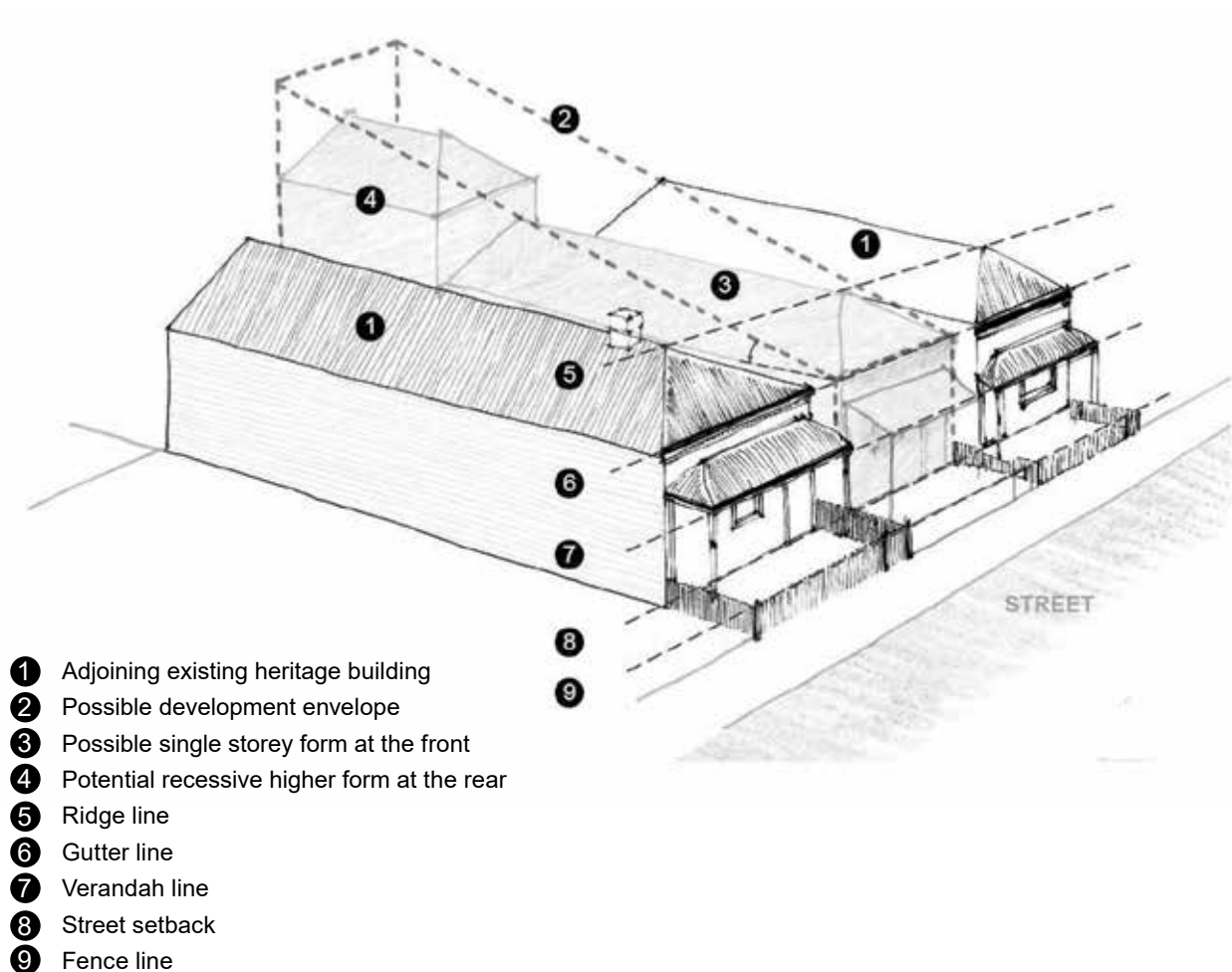

Figure 4.1.

Key considerations for residential infill development in a consistent streetscape.

In a **diverse streetscape** new buildings should use an interpretive approach. This approach will vary according to the degree of diversity in the streetscape. Two scenarios are shown here as examples:

- In Scenario 1 (Figure 4.2) the streetscape is consistent (single storey detached houses with hipped roofs) except for the one 'atypical' building. In this case, the new building could interpret the form, scale and materiality of the 'typical' buildings.
- In Scenario 2 (Figure 4.3) there is more diversity. In this case, there is scope for a freer interpretative design that may reference the contributory features of neighbouring places but does not closely follow them.
- In both scenarios, the new building should provide a sympathetic transition between the adjoining buildings (also refer to Page 12 *Consistency and diversity* in Responding to Context for further guidance).

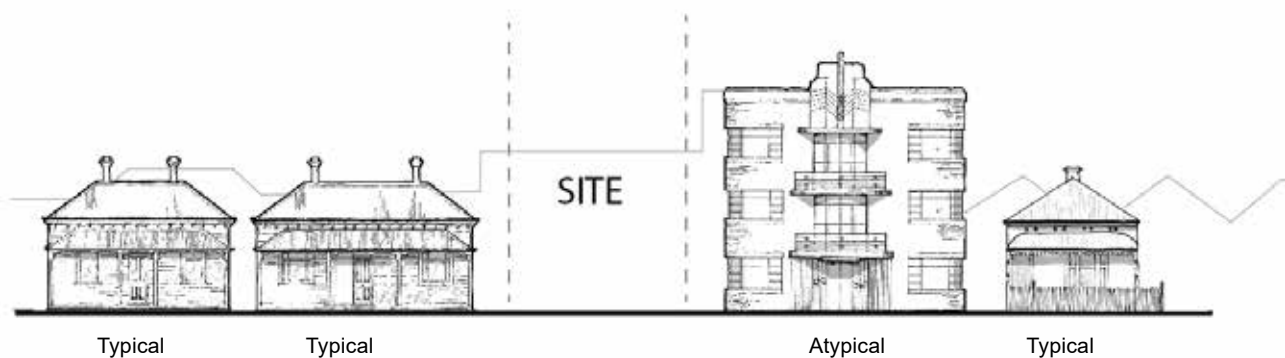

Figure 4.2.

Scenario 1: A site adjacent to an 'atypical' heritage building within an otherwise consistent streetscape



Figure 4.3.

Scenario 2: A site within a streetscape with a variety of building styles, forms, and scale

Commercial and retail infill

As shown in Figure 4.4, in a consistent streetscape new buildings should:

- Not exceed the maximum height of buildings on adjoining lots but may incorporate a higher section at the rear, if it is recessive and does not dominate the heritage place.
- Respect the following characteristics, as appropriate:
 - > Building proportions
 - > Street wall height and parapet height
 - > Roof concealed behind parapet
 - > Entry proportions and framing

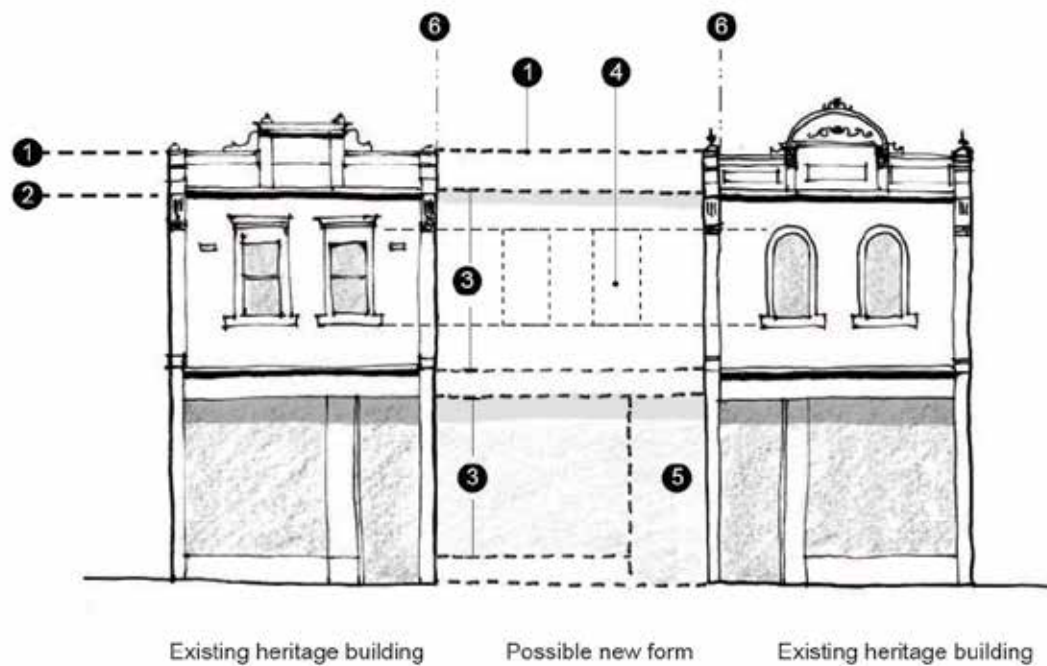

- ① Parapet height
- ② Street wall height
- ③ First and second floor proportions
- ④ Window size, spacing and proportions
- ⑤ Entry proportions and framing
- ⑥ No side setback

Figure 4.4.
Commercial infill in a consistent streetscape

Development on strategic development sites

New buildings on strategic development sites where higher density development is encouraged should respect the scale and setting of the heritage place. Key considerations are shown in Figure 4.5.

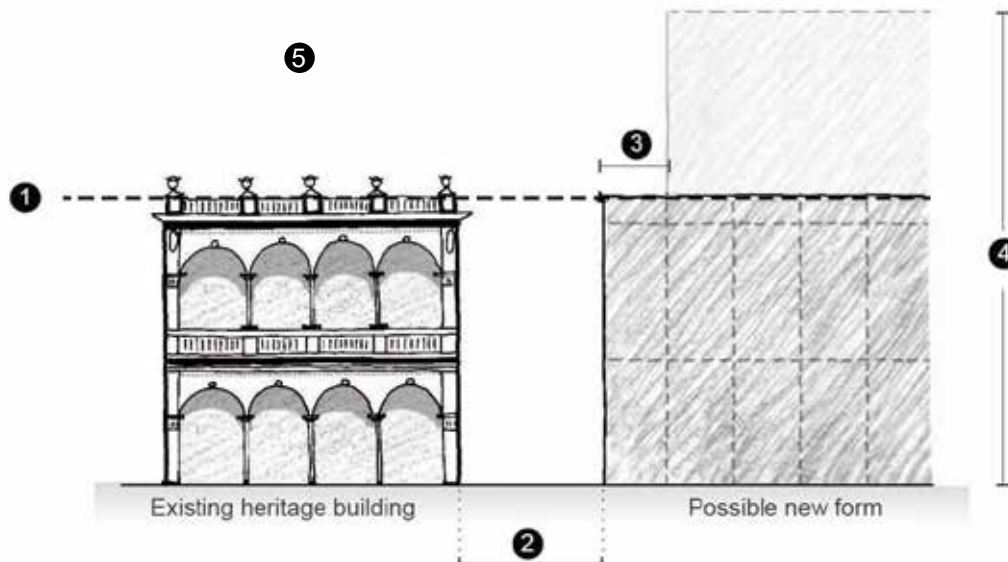

- ① Podium height to respond to parapet height
- ② Ensure adequate separation
- ③ Upper floor setback
- ④ Maximum building height
- ⑤ Not extend into the air space above

Figure 4.5.

Key considerations for new development on a site with an existing heritage building

Setbacks

In a consistent streetscape the front and side setbacks should match the setbacks of adjoining buildings.

Where there are heritage places on adjacent sites with differing front setbacks, an average setback may be used as shown in Figure 4.6 except for as shown in Figure 4.7 and 4.8.

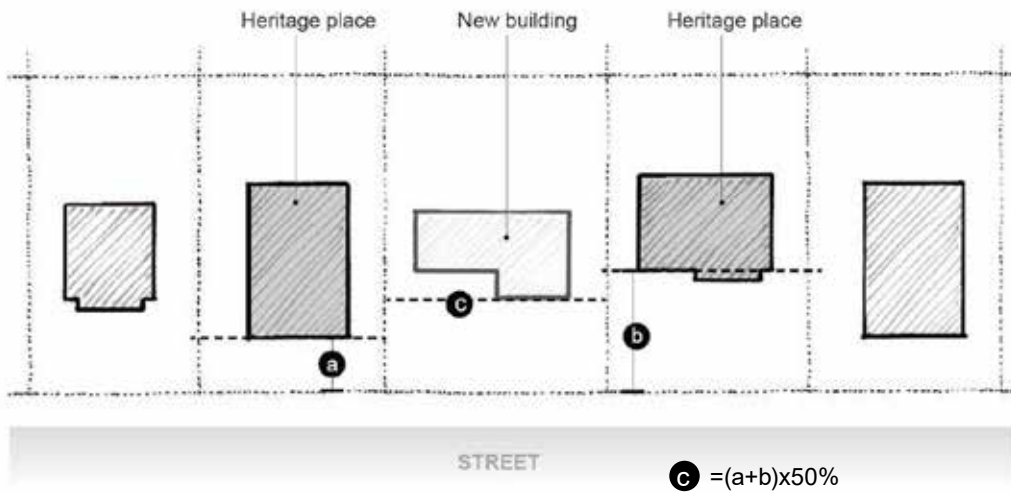

Figure 4.6 Average setback distance between heritage places.

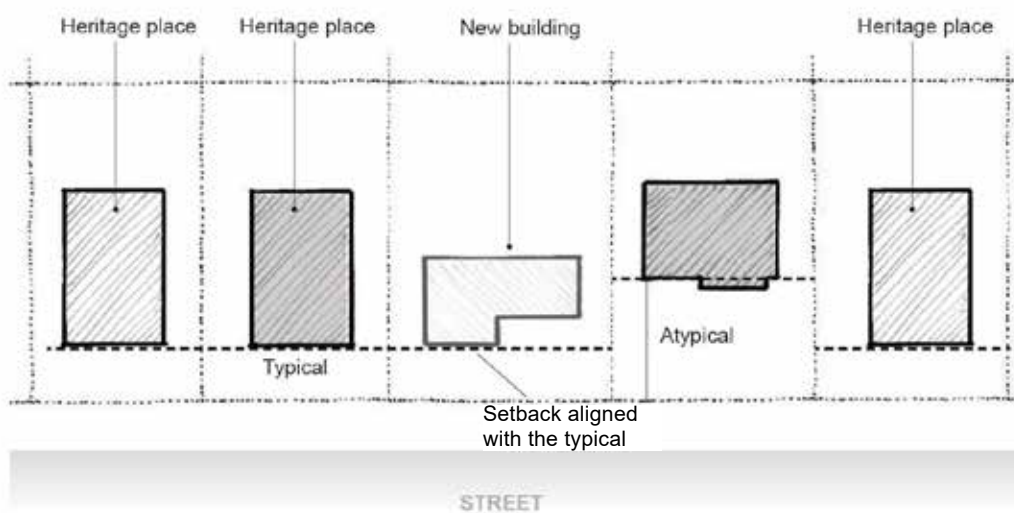

Figure 4.7 Use typical setback if the neighbouring place is different from the typical.

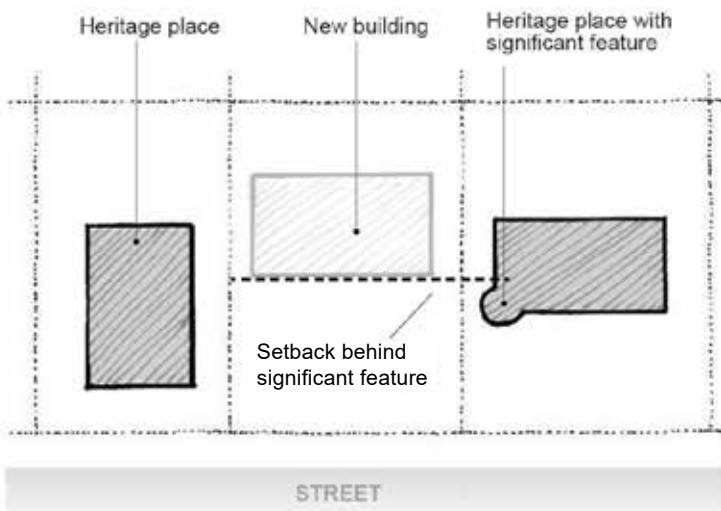

Figure 4.8 Increased setback to maintain view to significant heritage feature such as a corner window or tower.

In commercial areas new buildings should:

- Be constructed to the front boundary and to the side boundaries in line with adjoining buildings.
- Incorporate an angled splay on street corners where these are present on adjacent or opposite corners, as shown in Figure 4.9.

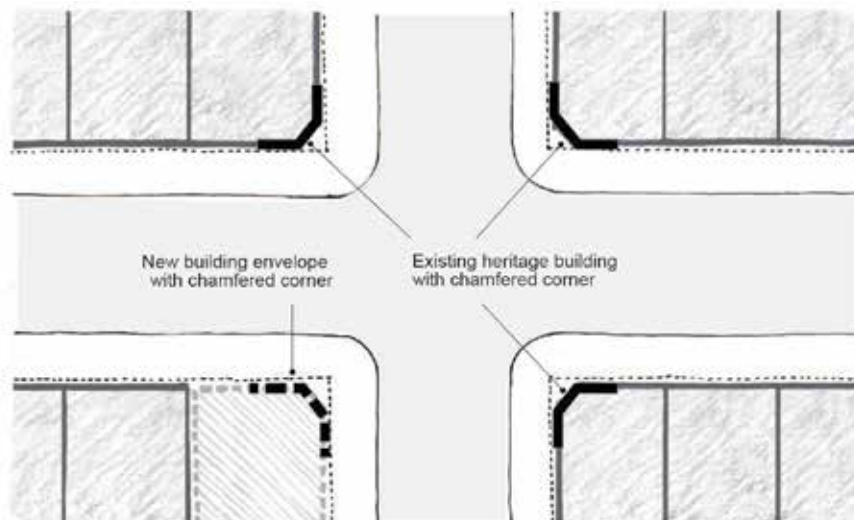

Figure 4.9.

Incorporation of corner splay to a commercial building where this is typical of the area.

Sitting and orientation

In a consistent streetscape, new buildings should have the same sitting and orientation as other buildings that contribute to the significance of the precinct.

For example, if houses are detached with consistent side and front setbacks then this should be adopted.

Fenestration and openings

New windows should respect and respond to the location, size and proportions of traditional windows on buildings that contribute to the significance of the heritage place.

The design should consider the relationship of solid space (walls, solid) to void space (windows, void). In particular:

- A new building should have about the same (i.e. neither more nor less) void space, such as glazing, than surrounding heritage places.
- Avoid large areas of glass, except for ground floor façades of retail or commercial buildings.

Details, colours, materials and finishes

External details, colours, materials and finishes should complement and not simply copy the finishes and detailing found on heritage places.

Avoid:

- Mock or imitation period detailing.
- Bright, reflective or mirrored materials or finishes, or
- Use of many and/or contrasting colours or finishes.

Case Study 3 – Contemporary residential infill

This building interprets the traditional Edwardian brick houses in a contemporary manner. As a new build in the middle of an established heritage setting, the design pays tribute to the brick and gable traditions in the neighbourhood. The success of this design is due to the fine craftsmanship of the stretching brickwork and sculpted façade with deep reveals to the window and entrance providing a contemporary reference to the traditional porches and verandahs of the surrounding houses.

From a distance, the front façade blends into streetscape but the contemporary twist in the brick bonding and facade sculpting immediately reveals itself when viewed close up. This is a good example that demonstrates how contemporary design does not have to look exactly like traditional architecture to be sympathetic to its character.



Photo 16. Ground Floor Facade of Bayside House, Adam Kane Architect

The background features a large, abstract geometric composition. On the right side, there are several overlapping triangular shapes in various shades of teal, ranging from a light, almost white-blue to a deep, dark teal. These shapes are set against a light grey background that occupies the left and top portions of the page. The overall aesthetic is clean, modern, and minimalist.

Guideline 5: Car parking

This section provides guidelines for the construction of crossovers, driveways and parking areas and structures including carports and garages.

Application

These guidelines apply to all properties.

Guidelines basis

In the nineteenth century, stables to accommodate horses were usually only associated with mansions and larger villas. They were always located at the rear of the property and accessed via laneways.

Dedicated car parking areas on residential properties began to appear from the 1920s onwards and by the 1930s had become a common feature within streetscapes.

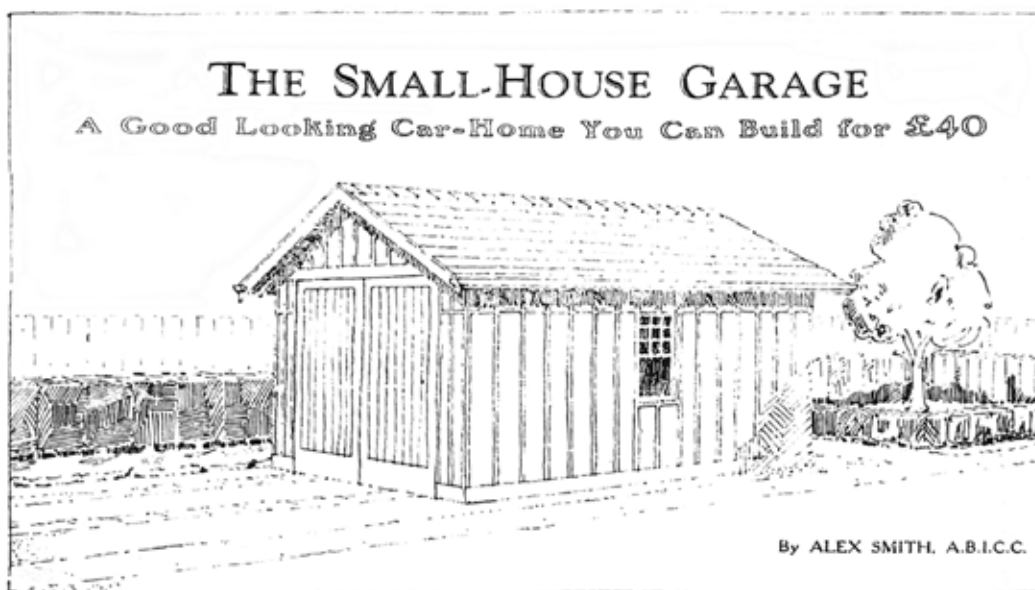

This design for a simple 'small-house garage' was featured in the September 1927 issue of Australian Home Beautiful. It was commissioned by the Editor in response to 'many requests' for a design that could be 'carried out by an amateur of moderate skill' and 'yet be different from the common galvanised iron or weatherboard shed'.

Because of this, features such as crossovers, driveways, parking areas and structures are not found in historic streetscapes dating from prior to the 1920s and introduction of these will result in adverse impacts by reducing the integrity of historic streetscapes and disrupting the traditional visual relationship between houses and the street.

Crossovers and driveways

Avoid widening existing crossovers, particularly when this would require altering a fence and removing tree planting that contributes to significance or setting of the heritage place.

An existing crossover may be relocated if:

- The width of the crossover is not increased.
- It does not require the alteration of a fence or impact upon a tree that contributes to the significance or setting of the heritage place.



Photo 17. The original driveway and crossover, Los Angeles Court, Ripponlea

While the Heritage Policy discourages new crossovers and driveways at the frontage of properties, they may be considered in streets comprising predominantly interwar houses where crossovers are part of the historic character of the heritage place and the following conditions can be met:

- There is no more than one crossover per property.
- The installation of the crossover and driveway does not require the alteration or removal of a feature that contributes to the significance of the heritage place such as a fence or tree.
- Cars can be parked at the side of the house or within the rear yard, and not within the front setback area, as shown in Figure 5.1.

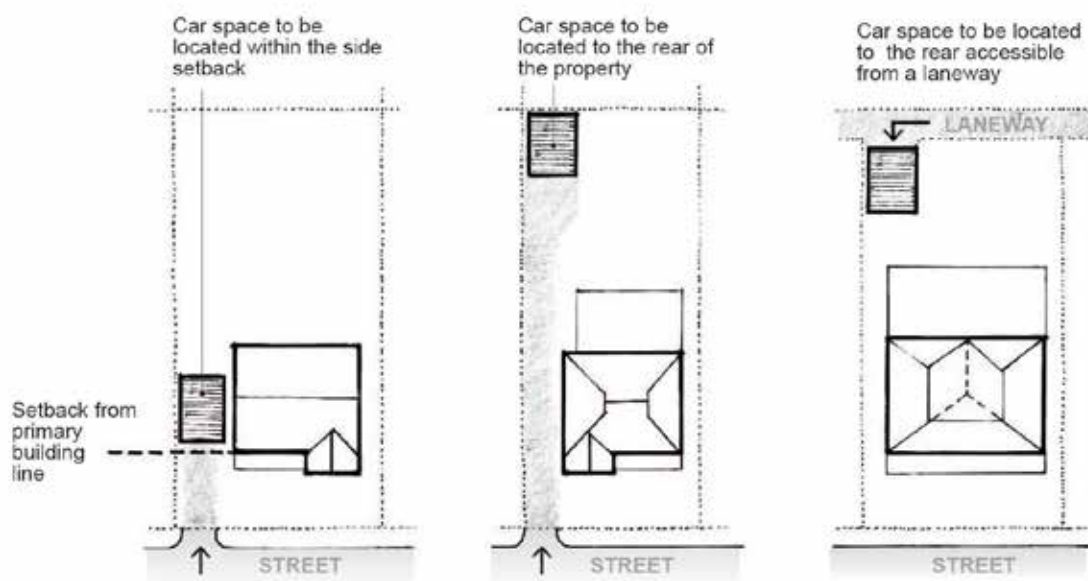

Figure 5.1
Potential locations for garages or carports.

Carports and garages

As shown on Figure 5.1 new carports or garages for Contributory or Non-contributory residential heritage places should be freestanding and may be constructed:

- Within rear yards, or
- Within side setback areas provided there is a minimum setback of 1 metre from the front wall of the dwelling.

Carports or garages should be simply designed and avoid copying the form or detailing of the house.

'Roller style' doors should be avoided and where possible the garage door should be integrated into the front wall of the garage.

Roller style garage doors may be permitted on rear laneways if the roller drum is enclosed and the adjoining lots facing the lane do not contain houses graded Significant or Contributory.



Guideline 6: Fencing

This section provides guidelines for the construction of fences.

Application

These guidelines apply to all properties.

Guidelines basis

Front fences and, to a lesser extent, side fences are an integral part of historic streetscapes as they form part of the visual relationship between the private dwelling and the public street. Fences were designed to complement and enhance the setting of houses and fence styles evolved and changed in line with architectural fashions over the years.

Historic fences where they survive are significant both for their contribution to the setting of heritage places and streetscape and should be preserved. New fences should be sympathetic with historic streetscape character.



Photo 18. 'La Mascotte' is a fine example of an interwar house with an original front fence featuring a splayed corner entry framed by an archway.

Poorly designed fences, particularly high solid fences, or fences in inappropriate styles can have a significant impact upon the setting of buildings and streetscapes.

General

The Heritage Policy encourages the conservation of original or early front fences and gates and for new fences to be appropriate to the style of the house.

These guidelines may be varied based on documentary or physical evidence.

Front fence styles

For Significant and Contributory places front fences should be appropriate to the style of the house. As a rule:

- Simple dwellings had simple fences. For example, an ornate cast iron fence is inappropriate for a Victorian timber cottage.
- Timber dwellings typically have timber framed fences with (depending on the style) vertical timber picket or sheet metal infill (for Victorian and Federation/Edwardian dwellings), or vertical timber picket or cyclone or woven wire (Federation/Edwardian and interwar dwellings).
- Masonry dwellings have either timber framed fences or masonry and/or metal styles.

If an original fence or part of one survives or there is an existing reproduction fence in an appropriate style, then that should be used as the model for the new fence.

If no original fences survive, then a fence style appropriate to the building should be chosen and applied consistently if the house forms part of a row or group of related houses (see Photo 19).



Photo 19. The owners of this terrace row in Middle Park cooperated to reinstate a traditional Victorian style front fence.

If the original fence no longer exists on the property, it will probably have been constructed of timber. The more permanent types tend to persist. Therefore, unless there is evidence to the contrary, a new timber fence will usually be most appropriate.

An alternative to a historically correct reproduction front fence is a simplified contemporary fence. For example, if situated in a predominantly Victorian or Edwardian precinct, the fence could be a simple plain timber picket or metal palisade, but stripped of any 'period' detailing. In an interwar precinct a low brick or rendered fence may be appropriate. This type of fence is also appropriate for a Non-contributory property.

Ideally fences to matching groups, terraces and attached pairs of common design should be identical. Where one or more of a group or pair has an original fence or, if not, an appropriate new fence, this fence will be taken as the pattern for all new fences in the group or pair. On terraces and pairs, the fence and side boundary posts should be shared and located centrally on the joint boundary.

Front fence heights and locations

The height of new fences should be appropriate for the style of building. As a guide:

- For Victorian and Federation dwellings of single storey, 1200mm to 1350mm.
- For Victorian dwellings where the verandah is on the street boundary, balustrade of 850 – 1000 mm from the verandah deck.
- For Victorian and Federation dwellings of two storeys, 1200mm to 1650mm maximum for posts.
- For Victorian or Federation mansions with extended frontages, higher fences (- 1800mm) may be appropriate.
- For Interwar dwellings, including apartment buildings, 600mm to 1000mm.
- For Mid 20th Century dwellings, zero to 900mm.

If an original fence or part of one survives or there is an existing reproduction fence in an appropriate style, then that should be used as the model for the new fence.

If no original fences survive, then a fence style appropriate to the building should be chosen and applied consistently if the house forms part of a row or group of related houses (see Photo 18).

If the original fence no longer exists on the property, it will probably have been constructed of timber. The more permanent types tend to persist. Therefore, unless there is evidence to the contrary, a new timber fence will usually be most appropriate.

An alternative to a historically correct reproduction front fence is a simplified contemporary fence. For example, if situated in a predominantly Victorian or Edwardian precinct, the fence could be a simple plain timber picket or metal palisade, but stripped of any 'period' detailing. In an interwar precinct a low brick or rendered fence may be appropriate. This type of fence is also appropriate for a Non-contributory property.

Ideally fences to matching groups, terraces and attached pairs of common design should be identical. Where one or more of a group or pair has an original fence or, if not, an appropriate new fence, this fence will be taken as the pattern for all new fences in the group or pair. On terraces and pairs, the fence and side boundary posts should be shared and located centrally on the joint boundary.

For Non-contributory properties choose a fence height that is appropriate for the predominant style of Significant or Contributory places within the streetscape.

Front fences should be located on the street boundaries.

For more information see the following **Heritage Practice Notes**:

1. Fencing in Heritage Overlay areas
 - 1A. Victorian timber front fences
 - 1B. Victorian metal front fences
 - 1C. Federation & Edwardian front fences



Guideline 7: Signage

This section provides guidelines for signage.

Application

These guidelines apply to all properties.

Guidelines basis

Examples of early or original signage are significant for the ability to illustrate the historic development of commercial and retail centres and provide also provide evidence of historically appropriate designs and location of signs.

It is important to strike a balance between the needs of businesses to have adequate exposure, and the need to ensure that new signage does not become a dominant element that detracts from the historic character of commercial and retail heritage precincts in Port Phillip.



Photo 20. The faded painted signs on this building in South Melbourne provide evidence of its historic use as a corner shop.

Original signage

Original signage should be conserved in accordance with the Conservation guidelines.

This may include the restoration or reconstruction of missing or incomplete historic signage based on physical or documentary evidence.

Many original or early signs were painted and have deteriorated over time. In some cases, the action may be to stabilize the sign and prevent further deterioration rather than undertake full restoration.

New signs

Examples of early or original signage are significant for the ability to illustrate the historic development of commercial and retail centres and provide also provide evidence of historically appropriate designs and location of signs.

It is important to strike a balance between the needs of businesses to have adequate exposure, and the need to ensure that new signage does not become a dominant element that detracts from the historic character of commercial and retail heritage precincts in Port Phillip.

Figure 6.1 shows the preferred locations for signage on commercial or retail heritage buildings provided the following conditions are met:

- There should be no more than one above verandah sign per building.
- Above verandah signage should not be floodlit or internally illuminated.
- Floodlit below verandah signage may be permitted only when:
 - > The light source is located so that light is directed onto the sign as much as possible to minimise glare.
 - > Light spillage from the light source is controlled by the use of baffles, shields or reflectors.
- Internally illuminated below verandah signage may be permitted only when the sign is not animated and does not include flashing or running lights.
- Colours, lettering, style and layout of signage respect the character and style of the building.
- External lighting, electrical cables and conduits and any other equipment associated with the signage is concealed from view, unobtrusively located or otherwise treated to minimise visual impacts.

Avoid the following types of signs:

- Above verandah signs, except as shown in Figure 6.1.
- Animated, Electronic or Floodlit signs.
- Bunting sign.
- High-wall sign.
- Panel sign.
- Pole sign.
- Promotion or Major promotion signs.
- Reflective sign.
- Sky sign.
- Advertising signs attached to street furniture including seating, shelters, phone booths and the like.

Avoid signs that conceal or obscure architectural features and detailing, windows and door openings, or project above verandah or awning fascias.

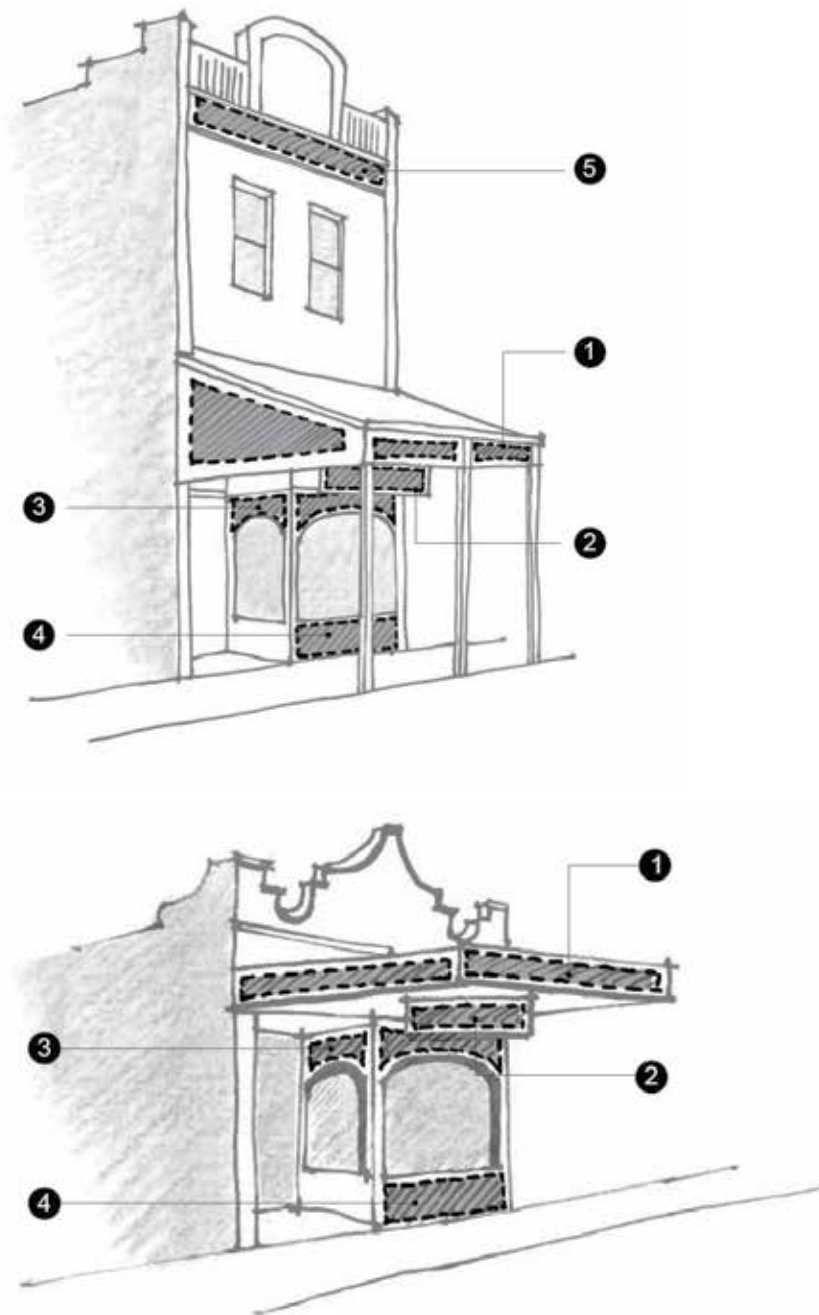

- ① Fascia mounted: retaining space surrounding sign
- ② Below awning: attached to a lightweight frame
- ③ On windows: as a decorative frame feature
- ④ Below windows: flush to facade, as a decorative panel feature
- ⑤ Above verandah: below pediment and/or cornice, and retaining within panel area

Figure 6.1
Preferred sign locations on commercial or retail heritage buildings

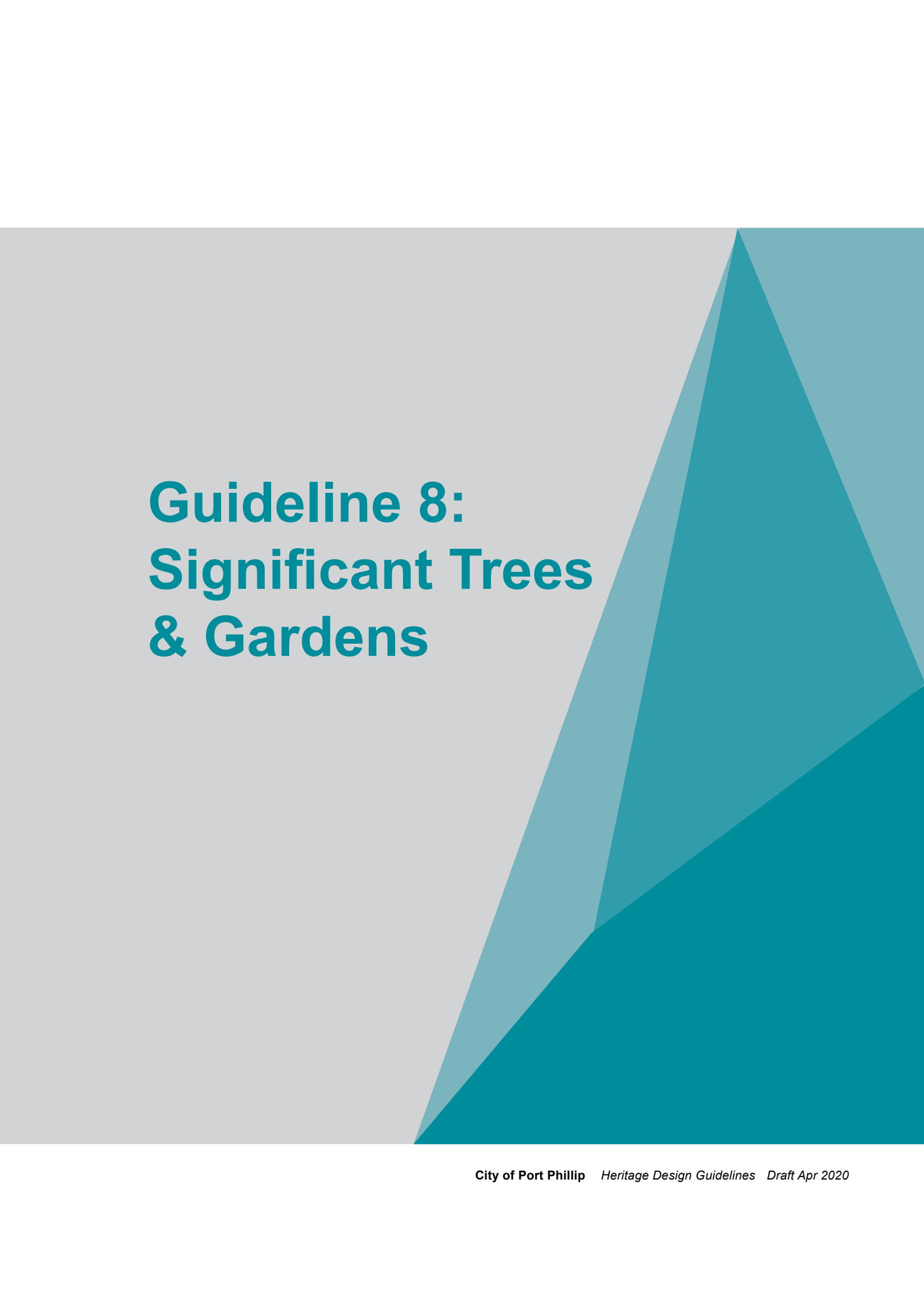
The background features a light grey gradient on the left side, transitioning into a large, abstract teal shape on the right. This teal shape is composed of several overlapping triangles and polygons, creating a dynamic, geometric composition. The teal color is a rich, medium-dark shade.

Guideline 8: Significant Trees & Gardens

This section provides guidelines for the management and conservation of significant trees and garden layouts on both private and public land.

Application

These guidelines apply to Significant and Contributory places where tree controls apply or that have remnants of early garden layouts.

Guidelines basis

Mature trees make an important contribution to the historic significance and aesthetic character and setting of heritage places. These include trees forming part of private gardens, as well as trees on public land lining streets and within parks and gardens.



Photo 21. The mature street trees lining Dandenong Road make an important contribution to the historical boulevard character.

As well as introduced trees, significant trees in Port Phillip also include remnant indigenous trees such as the Ngargee Tree in Albert Park (which has Aboriginal cultural significance) and eucalypts in Alma Park East.

The aim of these guidelines is to encourage the retention of these trees within their normally expected lifespan and to avoid development that could threaten their on-going viability. They also provide guidance for replacement when required.

While original garden plantings rarely survive on private properties, pathways and driveways, garden border tiles or edging, fencing, walls, ponds and other features sometimes survive as evidence of early garden layouts.

Working next to trees

Any new development in proximity to a significant tree (on the same or a nearby site) should be accompanied by an arborist's report that identifies:

- The recommended separation distance and any other measures to avoid detrimental impacts upon the health and viability of the tree.
- Any remedial pruning required.

Replacing trees

The Heritage Policy encourages 'Like for like' replacement, which means using a tree of the same species.

An alternative species of tree, or no replacement, may be considered when:

- Changes in the site conditions since the tree was first planted mean that the original species is no longer appropriate, or is no longer suitable (for example, due to size, form or proximity to buildings or services).
- The original species is inappropriate given the local climate (or climate change), soils, threat from pest or disease (for example, Elm leaf beetle), or for other reasons.
- The original species is identified as an environmental weed and cannot be appropriately managed when planted.
- Where trees form part of a row, avenue or hedge planting of consistent height, consider whether it would be appropriate to remove adjoining trees to ensure consistency as new trees mature.

Gardens

Conserve original features associated with original or early garden layouts such as pathways and driveways, garden border tiles or edging, fencing, walls and other features.

Encourage planting that is appropriate for the style and period of the house and garden.

The background features a light grey gradient on the left side, transitioning into a series of overlapping teal-colored geometric shapes on the right. These shapes include a large triangle pointing upwards and another larger, more complex shape below it, creating a modern, architectural feel.

Guideline 9: Sustainability and services

This section provides guidelines for the installation of equipment associated with sustainability and building services such as solar panels, water tanks, heating and cooling systems and hot water services.

Application

These guidelines apply to all properties.

Guidelines basis

Council supports the installation of equipment that will improve the environmental sustainability of a building. These guidelines show how this can be achieved without adversely impacting upon heritage significance.

Heritage buildings are capable of adaptation to include new and upgraded sustainable services through a sensitive and considered approach in the choice of **technologies, siting and design** of the sustainable system.

Before adding equipments to a heritage place, consider a set of comprehensive methods that can improve energy performance. For example, most weatherboard houses constructed prior to 1990 are likely to have uninsulated walls, ceilings and floors. Insulating these areas can reduce energy consumption and subsequently the size and running cost of the equipments needing to be installed.

The following guidelines have a particular focus on the roof mounted systems such as solar panels and solar hot water because they have the most potential for adverse impacts due to visible location on buildings.



Photo 22. An example of frameless solar panels on a slate roofed building

Service equipment

Service equipment such as air conditioning, heating or hot water boilers and the like should be concealed from the public realm. They should not be located on, or in front of the front façade of a building or on the roof where they would be visible from a street, including a side street.

Ideally, such units should be situated at ground level and within the side or rear yard area.

See Figure 8.1, which shows potential locations to ensure concealment from the public realm. If this is done then a planning permit is not required (Please contact Council's Statutory Planning team to confirm).

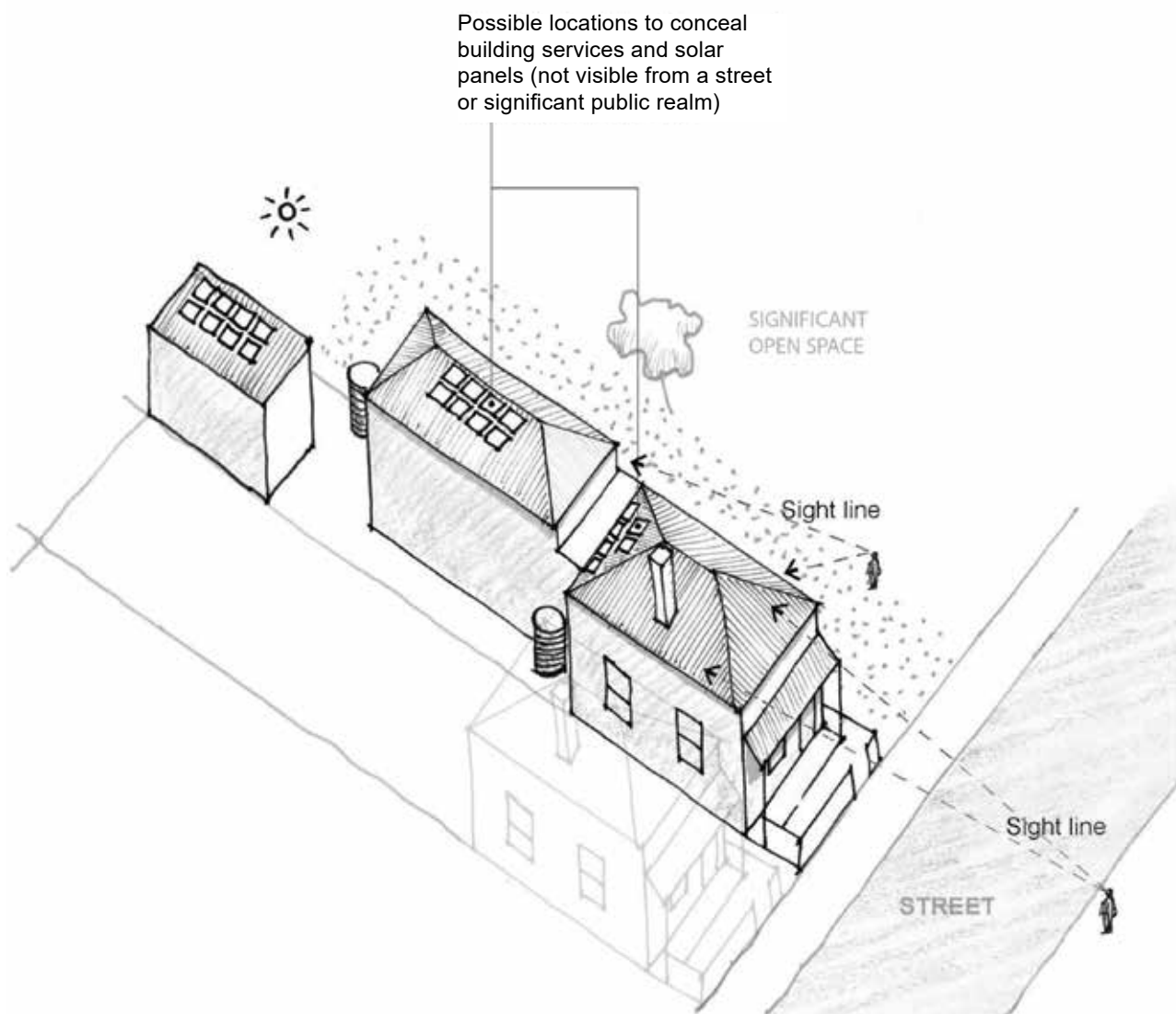

Figure 8.1
Suggested locations to conceal building services,
solar panels and water tanks

Environmental sustainability equipment

Ideally, environmental sustainability equipment such as solar panels and water tanks should be concealed wherever possible. If such equipment is not visible from the public realm (excluding a laneway) then a planning permit is not required. However, if this is not possible alternative visible locations will be considered on a case-by-case basis having regard to the context and the significance of the heritage place.

Figure 8.2 shows three alternative locations for roof-mounted solar systems:

- a. **Preferred locations** include ground mounted within rear or side yards, on non-significant outbuildings or additions, or non-visible sections of roofs on original buildings. These locations will not require a planning permit if they are not visible from the public realm (Please contact Council's Planning Department to confirm).
- b. **Secondary locations** should be used only when the preferred locations are not available or not practical (for example, due to orientation or overshadowing). They include side sections of roofs on original buildings, including on corner sites.
- c. **Visible locations** should only be used when the preferred or secondary locations are not practical. However, visible locations may not be suitable for narrow buildings, Significant places, or any building within an intact or consistent streetscape.

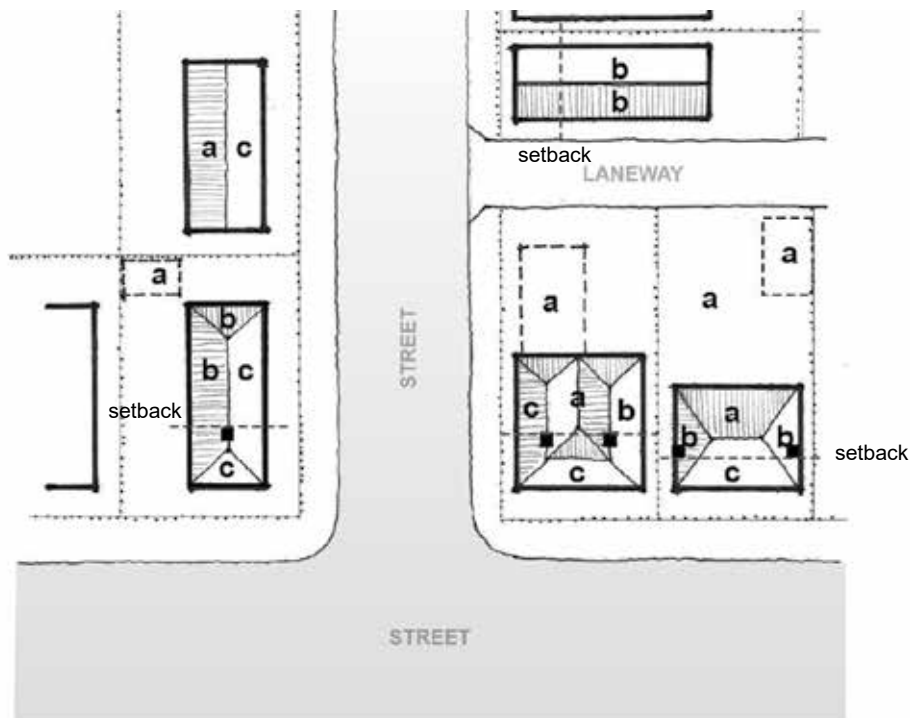

Figure 8.2
Alternative locations for roof-mounted solar systems:

For other types of roofs or context not shown in Figure 8.2, the location will be decided on a case by case basis using the same principles. Visible locations may not be suitable for complex roof forms particularly when solar panels will be mounted on multiple small roof planes.

Where roof mounted solar systems are visible they should:

- Be mounted flush against the roof (see Figure 8.3).
- Not project beyond the edge of the roof plane (see Figure 8.4).
- Be setback from the edge of the roof (see Figure 8.3) to ensure that some of the original roof remains visible.
- Be laid in a regular pattern that responds to the form of the house (for example, central location on the roof of a house with a symmetrical façade).
- Be in a colour that blends with the roof.

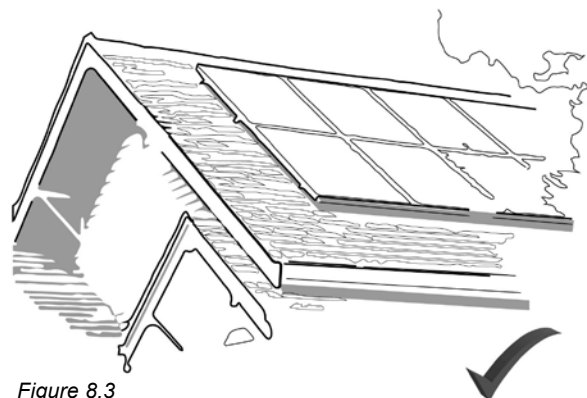

Figure 8.3
Be mounted flush against the roof and setback from the edge

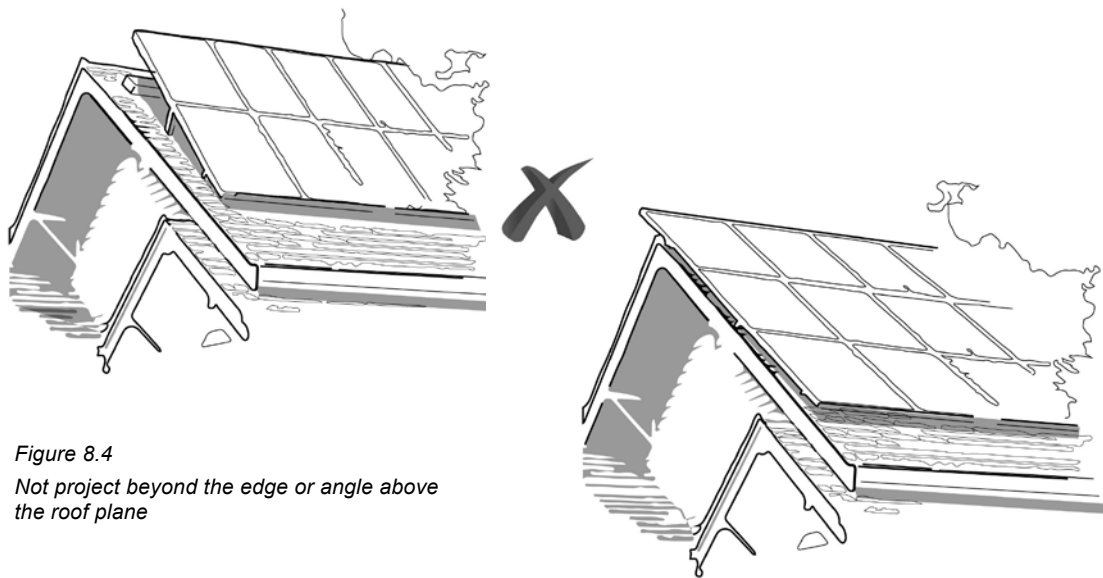
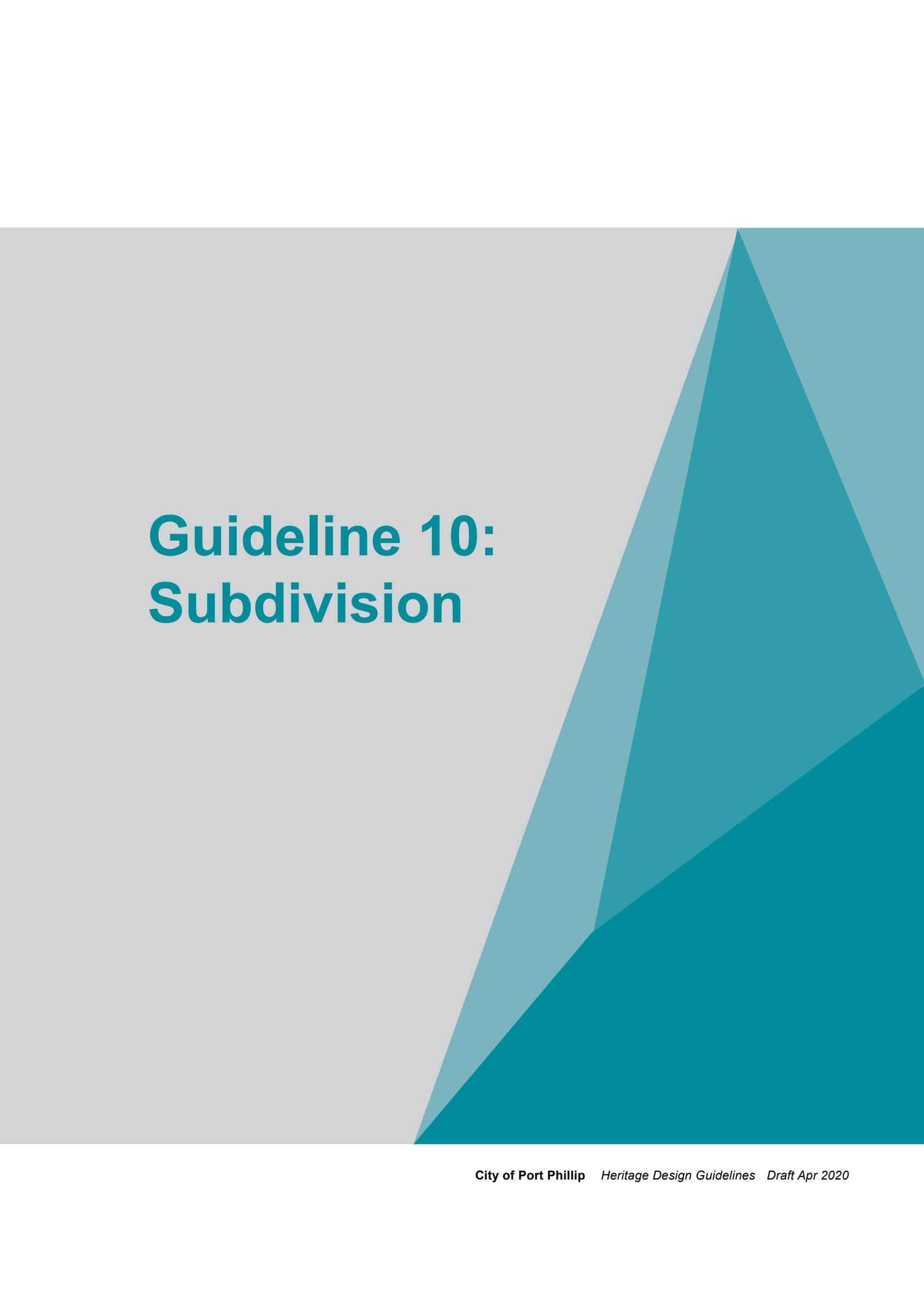

Figure 8.4
Not project beyond the edge or angle above the roof plane



Guideline 10: Subdivision

This section provides guidelines for the subdivision of land.

Application

These guidelines apply to Significant and Contributory places within the heritage overlay.

These guidelines do not apply to the subdivision of existing buildings that do not create an additional lot, or the internal subdivision (e.g. strata titling) of existing buildings.

Guidelines basis

The subdivision pattern in much of Port Phillip is typical of late nineteenth century/early twentieth century areas and comprises regularly shaped rectangular lots with consistent dimensions, some with access to rear lanes.

This has created streetscapes that have a consistent 'urban grain', which is reflected in the form and sitting of buildings creating a distinctive streetscape rhythm and character. Many precincts have a regular 'fine-grain' character comprising small consistently shaped allotments situated within a traditional 'grid' street network, while others have more irregular layouts that reflect layers of subdivision and re-development.

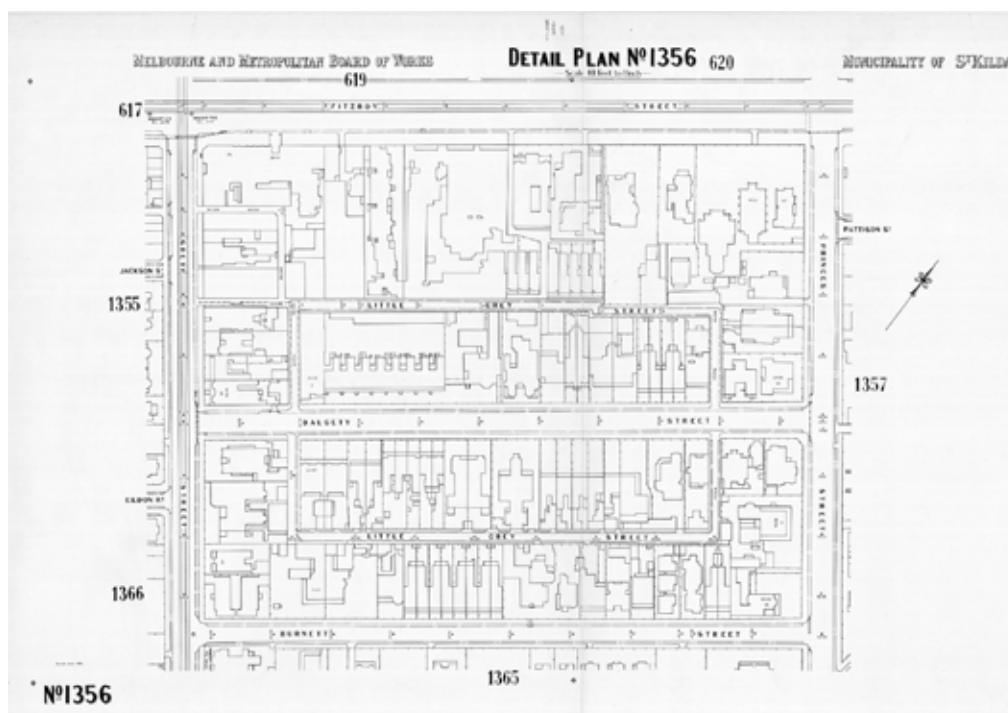

This Melbourne & Metropolitan Board of Works plan, dated 1948, shows the subdivision pattern in St Kilda.

It is important to ensure that future subdivision does not disrupt this character and, in addition, does not create the opportunity for inappropriate forms of development. When one large plot or multiple plots are to be developed, Council will assess if the proposed development has been informed by the pattern of the urban grain.

Subdivision guidelines

When large lots are subdivided, ensure lots sizes, proportions and depths are similar to those in the surrounding heritage precinct.

Avoid lots that are larger than or have shapes or proportions that are not found within the heritage precinct.

Avoid creating lots or lot boundaries that would:

- Cut through the middle of buildings, except as part of strata-titling.
- Result in contributory features associated with a heritage place being on separate allotments.
- Result in the loss of views to a heritage place.
- Allow new development between a heritage place and the street frontage.
- Require new buildings to have a lesser front setback than other buildings in the same street.
- Require the creation of a new street crossover to provide access.

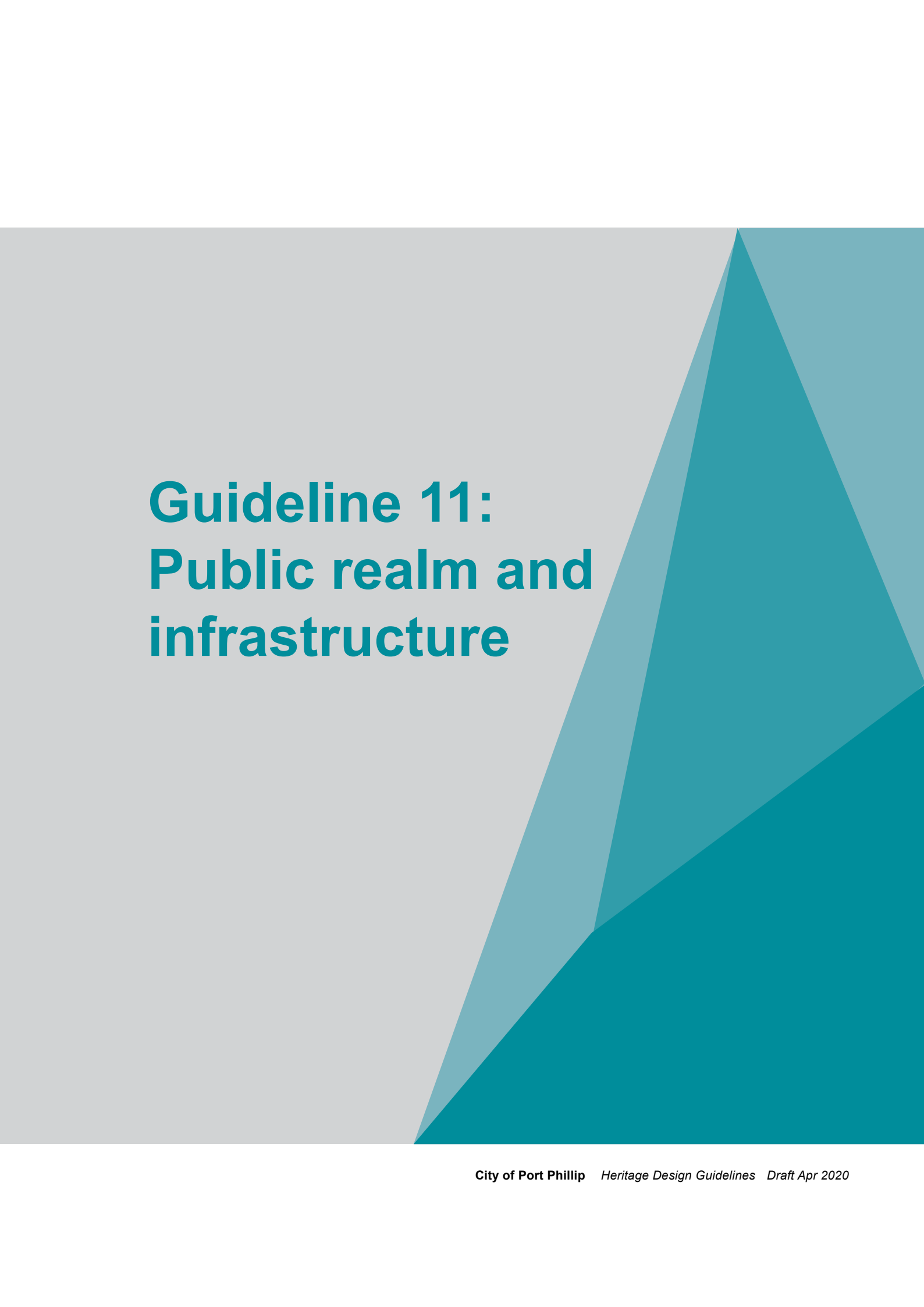
The background features a light grey gradient on the left side, transitioning into a series of overlapping teal-colored geometric shapes on the right. These shapes include a large triangle pointing upwards and several overlapping trapezoidal and triangular forms in varying shades of teal, creating a modern, layered effect.

Guideline 11: Public realm and infrastructure

This section provides guidelines for the conservation and management of land within the public realm including footpaths, streets and laneways, and features such as memorials, monuments and historic infrastructure associated with utilities (water, gas, electricity, sewerage, drainage).

Application

These guidelines apply to all historic public realm features and infrastructure within the heritage overlay.

Guidelines basis

The public realm (that is, the spaces between private properties including roads, footpaths and laneways) makes an important contribution to the historic character of heritage precincts and the setting of heritage places.



Photo 22. This laneway in St Kilda has been sympathetically re-constructed to retain the traditional bluestone channel and asphalt surface.

Of key importance is the historic use of bluestone in road construction from the nineteenth until the mid-twentieth centuries for kerbs, channelling and gutters, and laneways. This was often complemented by the use asphalt for footpaths and roads. Historic infrastructure also includes cast iron drainage and sewerage covers and grates, remnant gas lamp poles, electricity substations, horse troughs, and post boxes.

In addition, the public realm contains many important memorials and monuments honouring events and individuals.

It is important that these features are retained, and that missing elements are re-instated where opportunities arise.

Some old infrastructure or street furniture, while being part of the street character, can gradually lose relevance or purpose and become vulnerable to neglect, decay and possibly demolition. Some examples of this are the old post boxes, substations and tram shelters. The best way to save them is to breath new life through the adaptive reuse when renovating the public realm or developing the new infrastructure.

Public realm and infrastructure guidelines

Avoid demolition or removal of contributory features of public realm including:

- Bluestone pitchers as kerb and channel and laneways and footpaths.
- Original or early street furniture, lighting and signage.
- Original or early cast iron drain covers and grates, 'manhole' covers and the like.
- Early post boxes
- Early electricity substations.
- Monuments and memorials.
- Horse troughs.

Ensure that new public realm infrastructure:

- Respects, but does not simply copy the original materials, finishes and details of the historic infrastructure.
- Ensures the original layout, sitting, setting or details of the historic infrastructure is retained or remains evident.



Photo 23. The installation of this new kerb outstand and associated pedestrian crossing in Bank Street, South Melbourne uses sympathetic materials and also ensures that the historic alignment and layout of the original kerb and channel remains evident.

Overly relying on the interpretive signage should be avoided.

Avoid the need for complete reconstruction of kerbs, channels and laneways by undertaking regular repair and maintenance.

Reconstruct historic bluestone kerb and channelling only when it is at the end of its useful life.

When full reconstruction is required, this should be carried out in a way that reflects as closely as possible the original appearance.

Reinstate original bluestone kerb and channel or historic street furniture where this is supported by historic evidence.

Avoid development that would:

- Obstruct views of a memorial or monument.
- Result in the removal of trees or other features that contribute to its setting.
- Require its removal or relocation
- Potentially impact upon its condition or structural integrity (for example, due to construction being carried out in close proximity).

Encourage adaptive re-use of decommissioned infrastructure, where appropriate.

If the historical infrastructure is not capable of adaptive re-use then ensure there is a clear management plan. For example, Council is now responsible for maintaining the historic pre-World War 2 post boxes within the municipality.



Attachment 1: Definitions

Burra Charter definitions

Adaptation: modifying a place to suit the existing use or a proposed use.

Associations: the special connections that exist between people and a place.

Conservation: all the processes of looking after a place so as to retain its cultural significance.

Cultural significance: aesthetic, historic, scientific, social or spiritual value for past, present or future generations.

Fabric: all the physical material of the place including components, fixtures, contents and objects.

Interpretation: all the way of presenting the cultural significance of a place.

Maintenance: the continuous protective care of the fabric and setting of a place, and is to be distinguished from repair. Repair involves restoration or reconstruction.

Place: site, area, land, landscape, building or other work, group of buildings or other works, and may include components, contents, spaces and views.

Preservation: maintaining the fabric of a place in its existing state and retarding deterioration.

Reconstruction: returning a place to a known earlier state and is distinguished from restoration by the introduction of new material into the fabric.

Restoration: returning the existing fabric of a place to a known earlier state by removing accretions or by reassembling existing components without the introduction of new material.

Setting: the area around a place, which may include the visual catchment.

Use: means the functions of a place, as well as the activities and practices that may occur at that place.

Significance definitions

Heritage place is a place that has identified heritage value and could include a site, area, building, group of buildings, structure, archaeological site, tree, garden, geological formation, fossil site, habitat or other place of natural or cultural significance and its associated land.

Significant heritage places include buildings and surrounds that are individually important places of either State, regional or local heritage significance and are places that together within an identified area, are part of the significance of a Heritage Overlay. These places are included in a Heritage Overlay either as an area or as an individually listed heritage place and are coloured “red” on the City of Port Phillip Heritage Policy Map.

Contributory heritage places include buildings and surrounds that are representative heritage places of local significance which contribute to the significance of the Heritage Overlay area. They may have been considerably altered but have the potential to be conserved. They are included in a Heritage Overlay and are coloured “green” on the City of Port Phillip Heritage Policy Map.

Non-contributory properties are buildings that are neither significant nor contributory. They are included in a Heritage Overlay and have no colour on the City of Port Phillip Heritage Policy Map.